

# ONCORE™ PRO

## Operating Manual



# Table of Contents

<b>Section 1. Introduction</b> .....	<b>7</b>
<b>Section 2. System Specifications</b> .....	<b>8</b>
2.1. Instrument Overview .....	8
2.2. Module Overview .....	11
2.3. Technical Specifications .....	12
2.4. Accessories Included with the Instrument .....	13
2.5. Slide Specifications .....	14
Slide Dimensions .....	14
Tissue Thickness .....	14
Tissue Placement .....	14
<b>Section 3. Installation Requirements and Instructions</b> .....	<b>15</b>
3.1. Installation Requirements .....	15
3.2. Installation Instructions .....	15
Contacts for Assistance .....	16
<b>Section 4. Instructions for Use</b> .....	<b>17</b>
4.1. Starting Up the Slide Stainer .....	17
4.2. Preparing and Printing Labels .....	19
Add New Labels in the Barcode Editor .....	19
Print Labels in the Slide Label Editor .....	21
Move Slides to Printed Slides (for use with LIS only) .....	22
4.3. Loading Slides and Installing Chambers .....	22
Load/Unload Slides .....	22
Install/Remove Chambers .....	23
4.4. Assigning Protocols: Scan Slides and Manually Assign Protocols .....	24
4.5. Loading Reagents .....	26
4.6. Vialing Reagents .....	28
7mL Reagent Vial Specifications .....	28
15mL Reagent Vial Specifications .....	28
Instructions for Use .....	28
4.7. Managing Buffer and Waste .....	29
Refill the Wash Buffer Container .....	29
Empty the Waste Containers .....	30
4.8. Reagent Check: Scan Reagents .....	31
4.9. Starting the Run .....	35
Gantt Chart .....	37
4.10. Auto Start .....	38
4.11. Completing a Run .....	38
Runtime Monitoring .....	39
End of Run .....	40
Aborting a Run .....	41
4.12. Continuous Loading .....	42
Stop the Current Run .....	42
Restart the Run .....	43
4.13. Shutting Down the Slide Stainer .....	44
<b>Section 5. System Utilities</b> .....	<b>46</b>
5.1. Tools .....	46
Prepare Slides with Baking Slides Function .....	46
Load a Saved Slide Map File .....	47
Verify the Calibration of SP1-Z1 or SP1-Z2 .....	47

Verify the Calibration of the Barcode Reader .....	47
Clean Z1/Z2 Tubing .....	48
(Optional) Access the Tubing Clean Log .....	49
(Optional) Reset the Module/Chamber Usage Counter.....	49
Generate Reports.....	50
Move Robot XYZZ Arm to Middle.....	50
Perform System Initialization .....	50
Check for Module Malfunction .....	50
Flush Tubing with Prime Pump Z1 and Z2 Function .....	52
Prime Pump Z1 or Pump Z2 .....	52
Lock or Unlock Door .....	52
Backup Report Data .....	52
Replace Pump 1 Syringe or Pump 2 Syringe (Distributor Access only) .....	52
5.2. Editors .....	53
Editing Protocols in the Protocol Editor: Overview.....	53
Adjusting Protocol Customizations: IHC.....	55
Adjusting Protocol Customizations: ISH/CISH/FISH .....	57
Refreshing Protocol Customizations .....	58
Changing the Assigned Protocol Template .....	59
Adding New Protocols in the Protocol Editor .....	60
Creating and Modifying Special Protocols (Distributor Access only) .....	61
Creating and Modifying Protocol Templates (Distributor Access only) .....	63
Editing Protocol Parameters in the Advanced Protocol Editor .....	65
Configuring the Protocol Editor .....	68
Importing Protocols in the PR Manager.....	69
Exporting Protocols in the PR Manager (Distributor Access only) .....	70
Adding New Reagents in the Reagent Editor .....	72
Preparing RFID Reagent Tags with the RFID Tag Editor .....	75
Assigning Negative Controls.....	77
Creating Custom Groups .....	78
Creating Custom Panels .....	79
5.3. Security .....	80
Change Password .....	80
User Administration .....	80
5.4. Settings .....	81
Baking Slide Settings .....	81
2D Barcode Format .....	82
Label Format .....	83
Edit Doctor Name List .....	84
Check Heater Settings.....	84
Save All Customizations .....	84
Device Version.....	84
Baking Slides Option.....	85
Detect Waste Overflow Option (Distributor Access only).....	85
Run Without RFID Reader Option (Distributor Access only) .....	85
Reagent Consumption Priority.....	85
Software Version.....	85
Allowed Reagent Assignment (Distributor Access only) .....	85
Interlock Options (Distributor Access only) .....	85
Language .....	85
Tubing Clean Tracking Option (Distributor Access only).....	86
Module Tracking Option (Distributor Access only) .....	86
5.5. Network .....	87

5.6. LIS/LIMS .....	89
<b>Section 6. Reports.....</b>	<b>90</b>
6.1. Generate a Report .....	90
Slide Barcode.....	90
Patient Information.....	92
Staining Runs.....	93
6.2. Report Types.....	94
Slide Report.....	94
Reagent Usage in Run Report .....	96
Reagent Usage Report .....	97
Slide Summary Report.....	98
6.3. Print and Save a Report .....	99
6.4. Backup Report Data .....	99
<b>Section 7. System Maintenance .....</b>	<b>100</b>
7.1. Daily Maintenance Recommendation .....	100
Modules .....	100
Chamber.....	100
Tubing and Pumps.....	100
7.2. Weekly Maintenance Recommendation .....	101
Modules and Deck Plate.....	101
Wash Station and Z1/Z2 Probes.....	101
Tubing and Pumps.....	101
7.3. Monthly Maintenance Recommendation.....	102
Chambers .....	102
Tubing .....	102
Robotic Arm .....	102
Computer .....	102
7.4. Annual/Semi-Annual Maintenance.....	102
<b>Section 8. General Precautions .....</b>	<b>103</b>



## Instrument Information

**Oncore Pro Slide Stainer Model: ONCPRO0001**

**Software Version: 4.0**

**Computer Configuration:**

Laptop or Desktop Computer with Mouse

Instrument Communications Interface: USB 2.0

USB Cable must be <3 meters (10 feet)

**The use of this instrument is fully licensed under U.S. Patent no. 5,839,091; U.S. Patent no. 7,476,543; U.S. Patent no. 7,635,453; and U.S. Patent no. 7,977,086 B2.**

## Software Product License

IMPORTANT: Please read the license carefully before using this Software. The right to use this Software is granted only if the Customer agrees to the terms of this license

HOWEVER, USE OF THIS SOFTWARE INDICATES YOUR ACCEPTANCE OF THESE TERMS AND CONDITIONS.

In return for the payment of the applicable one time license fee included with the purchase price of the instrument, BioCare grants the user a license to use one copy of the Software subject to the following terms and conditions. No title or ownership of the Software is conferred with this license.

1. The Software may be used on one Oncore Pro Slide Stainer.
2. The Software may not be copied.
3. The Software may not be disassembled, decompiled, decrypted or reverse engineered.
4. BioCare reserves the right to terminate this license upon breach. In the event of termination at BioCare's election, all copies of the Software must be returned to BioCare.
5. No title or ownership of the Software is conferred with this license.

## Safety

**Report any serious incidents related to this device to your local Oncore Pro representative and the state's competent authority.** Contact your local representative if you have any questions or concerns regarding safety.



### **Protection from High Temperatures**

The instrument is equipped with a safety interlock system so that the door remains locked during instrument operation. However, the heaters inside may reach high temperatures. Care must be exercised to make sure that the heaters have cooled down sufficiently before removing the slides.



### **Protection from Moving Parts**

The instrument is equipped with a safety interlock system so that the door remains locked during instrument operation. The interlock will automatically engage to restrict access to the inside of the instrument while it is the instrument is in operation. Never tamper with the safety interlock system.



### **Use of Hazardous Reagents**

Some reagents used on the instrument may be considered hazardous. Hazardous reagent wastes must be disposed of according to local, state and federal regulations. Wear appropriate Personal Protective Equipment to prevent exposure. It is the responsibility of the user to comply with the local, state and federal regulations.



### **Maintenance**

**Do not attempt to service the instrument unless instructed to do so by Technical Support. Doing so will void the warranty. Removing the back panel may also electrical hazard.**

The instrument must be unplugged from the power source before the outer housing can be removed. The power supply is connected to 120/240V power source and the power cord must be disconnected from the AC power port before any maintenance work is started.

### **Decontamination**

Use bleach at 1:10 dilution to decontaminate the instrument. Do not use bleach with any other chemicals because it may react and create toxic fumes. Decontaminate in a well ventilated room.

# Section 1. Introduction

## **Intended Use of the Equipment**

The Oncore Pro Slide Stainer is a fully automated slide processing system for staining paraffin-embedded and frozen tissue sections, cytopins, cell smears and fine needle aspirates. This universal system is designed to automate the manual staining methods routinely used in immunohistochemistry, in situ hybridization and related applications.

## **Quick Start-up**

The Oncore Pro Service Team installs and tests each system to ensure optimal performance.

The system is factory-installed with a set of standard protocols optimized for use with the Oncore Pro detection kits and its comprehensive line of ready-to-use primary antibodies and probes.

## **Flexible Programming**

The Oncore Pro Slide Stainer software implements user-customized protocols and slide-specific programming. The system provides intuitive programming routines, reagent and slide loading maps and a convenient run time display. Each staining run can process 1 to 36 microscope slides. Each slide can be programmed to run a different protocol.

## **Economic Use**

The Oncore Pro Slide Stainer maximizes efficiency by operating with small volumes of reagent and wash buffer, effectively reducing supply and waste disposal costs. The system provides the flexibility to optimize reagent volumes and wash steps.

## **Reagent RFID Tags**

Reagent RFID tags store programmable information such as reagent name, lot number and expiration date. The on-board RFID reader scans and identifies reagent vials to automatically determine if there are sufficient resources to complete a selected staining protocol.

## **Slide 2D Barcode Labels**

The Oncore Pro Slide Stainer software provides a simple user interface to generate and print 2D Barcode labels for slides. The on-board 2D barcode reader scans and identifies slides to automatically program a run and track slides. All printed labels are heat and chemical-resistant, allowing users to apply slide labels prior to starting the staining procedure.

## Section 2. System Specifications

The Oncore Pro Slide Stainer system employs a unique integration of hardware, software, and reagent chemistry to provide full automation of immunohistochemical staining methods. This section provides an overview of the instrument and details the technical specifications.

### 2.1. Instrument Overview

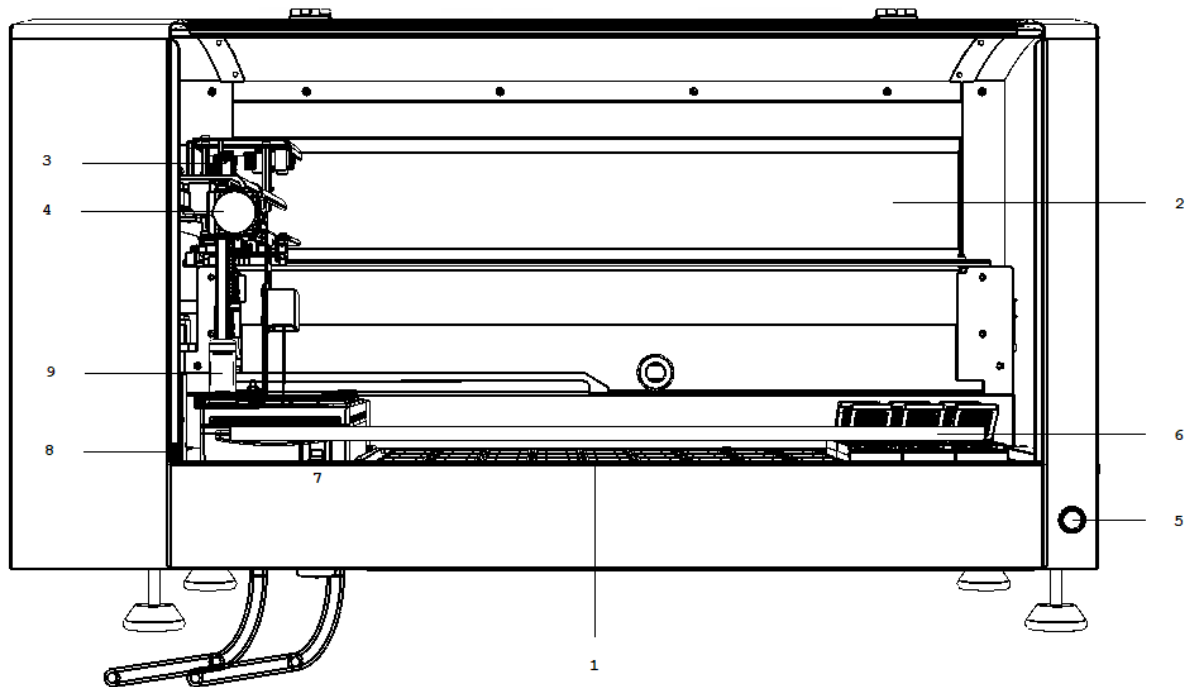

Figure 1

1. **Slide Deck** holds 36 modules, a reagent rack, and 2 probe wash stations.
2. **X axis mechanism** moves the robotic arm from left to right.
3. **Y axis mechanism** carries the Z head assembly and moves the arm from front to back
4. **Z head Assembly** consists of 2 independent Z axes (Z1 and Z2) situated on the Y arm.
5. **Power Button** turns the instrument on/off.
6. **Door controls** access to the instrument.
7. **Linear Solenoid** locks the door.
8. **Safety Interlock Switch** blocks unsafe access to the instrument while the robotic arm is in motion.
9. **Liquid Level Sensor (Z1 only)** detects the liquid level in the reagent vial and waste station during runtime. The system will issue a warning when a reagent vial has insufficient volume or when a waste station is overflowing.

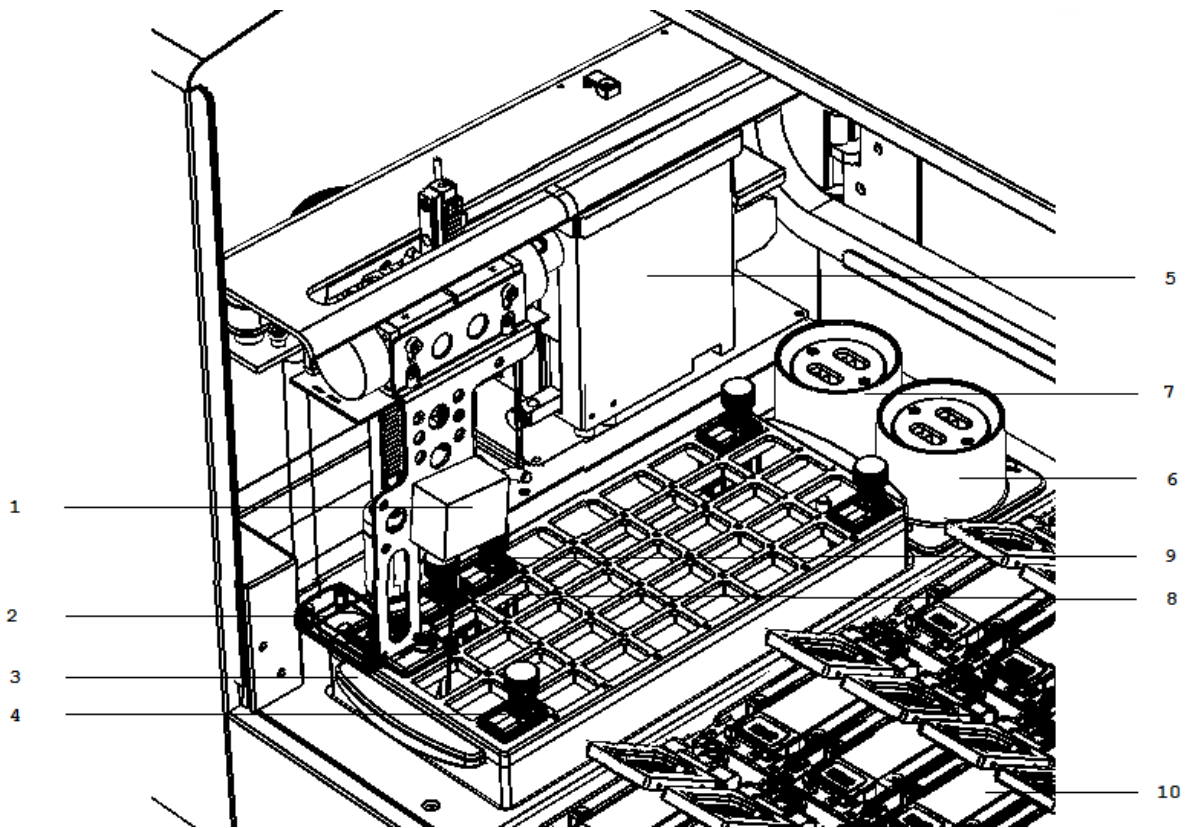

Figure 2

1. **2D Barcode Reader** scans the labelled slides on the slide deck to assign protocols for the staining run.
2. **RFID Reader** scans the RFID-tagged reagent vials to determine the reagents' positions on the rack and updates the reagent usage information to the RFID tags during the run.
3. **Reagent Rack** holds the reagent vials. There are 40 available reagent vials positions.
4. **Reagent Vials** holds the reagents. 15mL and 7mL size options.
5. **Pumps (Z1 and Z2)** draw and dispense buffer and reagents through the in-line tubing (max 5mL capacity)
6. **Wash/Waste Station** is an assembly located in the rear left corner of the instrument and is used as a cleaning station for the reagent probes. There is a purging position for the reagent waste and a percolating position for cleaning the outside of the probe each time a new reagent is used.
7. **Hazardous Wash/Waste Station** is a second probe wash station dedicated to hazardous reagents. Hazardous reagents will be separately dispensed into the hazardous waste station and will be collected in the Hazardous Waste Container.
8. **Z1 Probe** is a Teflon™-coated stainless steel probe that aspirates the reagents from the vials/in-line wash buffer and dispenses the reagents into the chambers.
9. **Z2 probe** is a Teflon™-coated stainless steel probe that extracts the reagent waste from the chambers and aspirates/dispenses reagent during on-board mixing.
10. **Module** is an assembly that holds 1 glass slide. 36 modules per instrument.

**Not pictured:**

11. **Tubing (Z1 and Z2)** connects the pumps with the probes to transfer buffer, reagents, and waste.

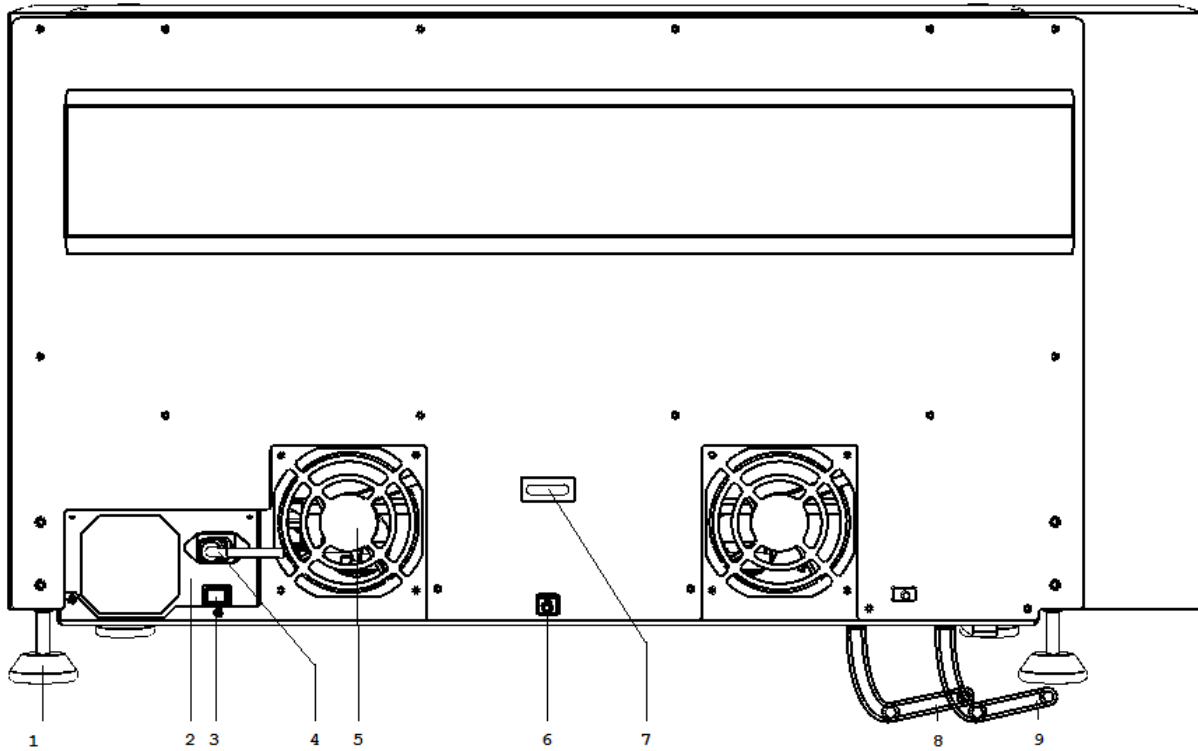
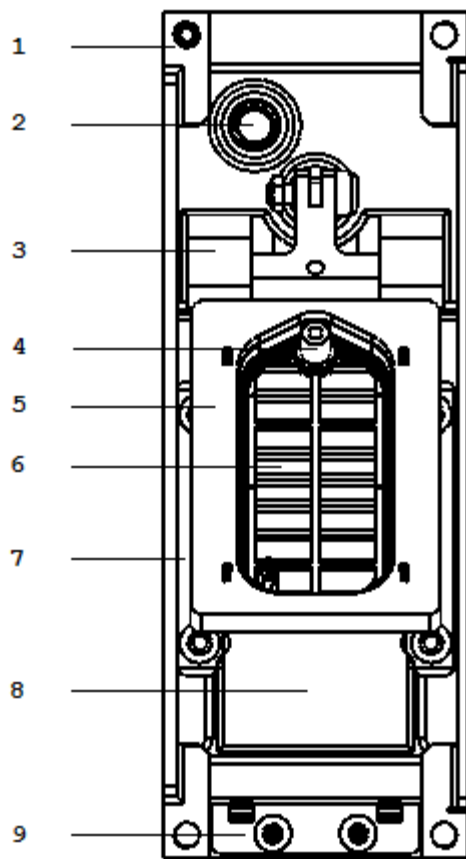

Figure 3

1. **Feet** adjusted to level the instrument on the work surface.
2. **Main Power Supply** connects to the wall outlet and provides power to the instrument.
3. **Power Supply Switch** turns the power supply on/off.
4. **AC Power Port** is the position to plug in the power cord.
5. **Fan** provides cooling to the instrument and its electrical components.
6. **USB Port** is the position to plug in the USB cable.
7. **U-Ring** is the position to attach an anti-theft chain to the computer.
8. **Waste Tubing (Blue)** connects the waste station to the waste container to transfer waste (gravity-fed).
9. **Hazardous Waste Tubing (Black)** connects the waste station to the hazardous waste container to transfer hazardous waste (gravity-fed).

## 2.2. Module Overview



1. **Side Retainer Clips (2)** secure the module onto the instrument deck plate.
2. **LED Light** displays heater status green (inactive) or orange (active).
3. **Hinge** secures the slide at the back.
4. **Chamber Chimney** reagent dispensation/waste extraction point.
5. **Slip Holder** holds the chamber. Moves to controlled angles to facilitate incubation and reagent dispensation/waste extraction.
6. **Chamber** (consumable) holds reagent/buffer on the slide during the incubation and washes.
7. **Side Rails (2)** secure the slide on the left/right.
8. **Heater** maintains temperature during incubation.
9. **Slide Clip** secures the slide at the front.

**Not pictured:**

10. **Glass Slide** is a standard microscope slide to which specimen(s) are mounted for processing on the instrument. Standard slide dimensions are 25mm x 75mm x 1mm.

Figure 4

## 2.3. Technical Specifications

### Dimensions W x H x D

36.5in x 22in x 24in/93cm x 56cm x 61cm  
(with door closed)

36.5in x 36in x 24in/93cm x 91cm x 61cm  
(with door open)

### Electrical requirements

120V 110/120V ( $\pm 10\%$ ) 60Hz ( $\pm 2\text{Hz}$ ) 850 watts  
220V 220/240V ( $\pm 10\%$ ) 50Hz ( $\pm 2\text{Hz}$ ) 850 watts  
Mains Connection: IEC320

### Slide capacity

1 - 36 glass slides

### Heating capacity

Room temperature to 103°C. Maximum 110°C.

### Reagent dispense volumes

130uL standard test volume  
(65 minimum-400  $\mu\text{L}$  maximum)

### Recommended Computer Controller Specifications

*The manufacturer reserves the right to change the computer controller specifications at any time.*

Intel Core i5-2410M CPU 2.3GHz, or equivalent  
8GB RAM  
500GB Hard drive or 256GB SSD drive  
4 USB 2.0 communication ports, or equivalent

### Display Specifications

16:9 aspect ratio, minimum resolution 1366 x 768

### Label Printer (ZPL)

Zebra GX430t, Zebra ZD620t, or Zebra ZD621t

### Surge Protector

120/240 VAC, 15 Amps, 50/60 Hz

### LIS Connectivity

Compatible with SQL Database and HL7 messaging standards.

### Operating Logic

Designed to calculate the most time-efficient sequence of steps to complete a programmed staining run.

### Protocol Logic

Protocols are generated from a common protocol template optimized for each detection system. End-users have the limited ability to customize key protocol steps. Advanced users have full flexibility to add/remove and customize each step in the protocol template and to generate special protocols.

### Weight

125lb (57kg)

### Normal operating temperature

18°C-26°C (64°F-79°F)

### Reagent capacity

40 different reagents (15 mL/7mL reagent vial)

### Waste Separation

1 hazardous waste, 1 non-hazardous waste

### Reagent probe volume capacity

20  $\mu\text{L}$  minimum-4500 $\mu\text{L}$  maximum

### Operating System

Windows 10 Pro (64 bit), English (US Region)



## 2.4. Accessories Included with the Instrument

**Reagent Rack** Two removable reagent racks. Each reagent rack holds a maximum of 40 reagent vials.

**Removable Vial Holder** Installed on the reagent rack for programming RFID-tagged reagent vials.

**Buffer Container** 2L plastic bottle with quick disconnect fittings. Stores the in-line wash buffer.

**Waste Container** Set of two 4L plastic bottles with cap. Stores the reagent waste generated during the run.

**Label Printer** 2D barcode printer, thermal transfer.

**Labels** Size 19.05mm (*0.75in*) x 25.4mm (*1in*), 1000 labels/roll.

**Ribbon** Media ribbon for the printer.

**USB Cable** Connects the instrument and computer.

**Power Cord, Instrument**

**Computer** Pre-configured for use with instrument.

**Computer Mouse**

**Lint-free Alcohol Wipes**

**Chamber** Set of 36 pre-installed on the modules.

## 2.5. Slide Specifications

To ensure staining quality and reliability, slides should be prepared following the instrument's guidelines.

### Slide Dimensions

Standard slide dimensions are 25mm x 75mm x 1mm

#### Material Glass, ISO 8037/1

	Dimensions (mm)
Width	25–26.0 mm (0.98–1.02 in)
Length	74.75–75.5 mm (2.94–2.97 in)
Thickness	0.95–1.1 mm (0.038–0.043 in)

 Note: Use of non-standard slides may affect staining area and staining quality.

### Tissue Thickness

The recommended tissue thickness is 2-5 microns.

### Tissue Placement

The circled area is the recommended tissue placement area.

The yellow highlighted region is the staining area range. This range may be expanded to the blue highlighted regions; however, staining results may not be ideal in these areas.

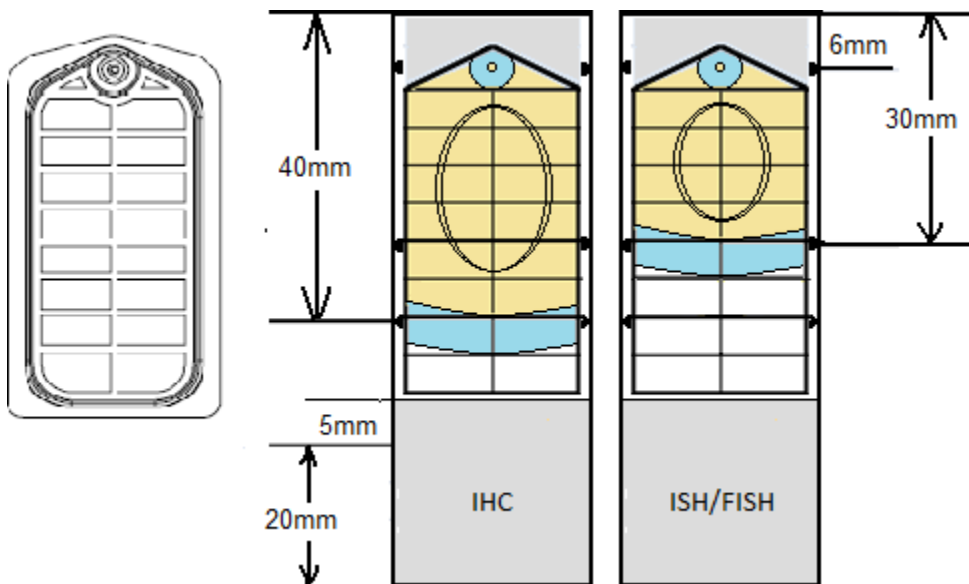

Figure 5

The IHC staining area extends to the 40 mm line on the slide.

The ISH staining area extends to the 30 mm line on the slide.

## Section 3. Installation Requirements and Instructions

This section provides an overview of the instrument installation to be performed by the field service engineer. The following requirements should be met to ensure proper instrument function.

### 3.1. Installation Requirements

**Location** Place the system in an area where it is easy to operate and easy to connect to the instrument.

**Surface** Prior to unpacking, ensure that the work area for the instrument is a solid, level surface that can safely support the weight of the system.

**Size** Minimum dimensions for the work area are 36.5 inch (93 cm) width x 36 inch (91 cm) height x 24 inch (61 cm) depth clearance.

**Environment** The work area must be in an environment with an ambient temperature between 18°C-26°C (64°F-79°F). The area must be properly ventilated with a maximum relative humidity of 80% for temperatures up to 31°C; Pollution Degree II or less. The equipment will produce less than 85 decibels at peak operation.

**Power source** The instrument and computer must be connected to a 120V/240 15A supply with grounding (3 prong). It is recommended to use a dedicated power source to prevent interference from other instruments or equipment. It is also recommended to use a UPS (uninterruptible power supply) with minimum 1500VA. This will help to prevent unexpected system failures due to an unstable power grid system or in the event of a temporary power outage.

### 3.2. Installation Instructions

**Unpacking** The system is packaged in a wooden crate mounted on a pallet. Unlatch all fasteners and remove the lid on top of the crate first. Remove the computer, accessories box and label printer from the crate. Remove the sides of the crate.

**Installation** Requires 2 people. Each person should pick up one end of the instrument and carefully lift it out of the crate. Carefully move the instrument to the operating area and place it on the bench. Level the instrument surface using a bubble level. Remove all packing material and the packaging securing the robotic arm. Verify that all axes can move freely before operating the instrument. Unpack and install the computer and accessories.

**Hooking up** Connect the USB cable from the designated port on the computer to the back of the instrument.



Do not plug and unplug the USB cable while the PC or Instrument is on.

\*\*\*Always turn off the instrument and PC before plugging and unplugging the USB cable.

Connect the Computer to the power source or UPS. Follow the instructions on the UPS, as some may require powering up for several hours to charge the internal battery. Using a standard IEC320 compatible power cord, connect the AC power port at the rear of the instrument to the power source or UPS.

Cut the waste tubing to size and route to the waste bottles on the floor. The ideal configuration is straight down to the waste bottle to minimize the chance of overflow and waste buildup.



**Avoid immersing the waste tubing in the waste bottle or flattening and kinking the tubing as this may disrupt the gravity fed drainage and result in waste overflow.**

**Starting up** Turn on the instrument and computer.

Power on the power supply switch on the back of the instrument.

Power on the Slide Stainer by pushing on the power button at the front of the instrument.



Log in to the computer.

Default **User Name**: *PathCom*

Default **Password**: *67471*

*Note: The user may change the computer user name and password after initial log in.*

Disable the Wi-Fi radio and local internet connection (if applicable).

This feature may cause unexpected crashes during instrument operation.



**The internet access should only be enabled for a remote support session, email communication or web conference call. Disable the internet access while the instrument is in operation to prevent unexpected crashes.**

Disable automatic time synchronization.

This feature may cause unexpected crashes during instrument operation.

For Windows 10 systems: Configure Time & Language settings within Windows Settings.

Toggle Off the Date and time options as shown.

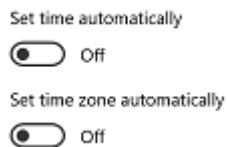

Figure 6



**Do not change the Windows Settings without consulting Technical Support, as this may cause unexpected crashes and performance issues. This includes settings for input language, OS language, region, regional formatting, power options, Windows Update etc.**

Setup the barcode label printer.

Load the ribbon and media according to the manufacturer's instructions.

Connect the printer to the designated port on the computer and switch the power on. The printer driver will automatically install within a few minutes.

Calibrate the media, if needed, using the Zebra Setup Utilities.

The on-site field representative will perform the necessary system checks on robot, modules, and pumps.

### **Contacts for Assistance**

**Customer Service: 925-603-8000**

**Technical Support: 1-800-799-9499 Opt. #3**

### **Replacement of Consumable Materials**

Replacements for all consumable materials can be obtained from:

**Website: [www. biocare.net](http://www.biocare.net)**

## Section 4. Instructions for Use

This section provides the instructions for daily routine operation of the instrument. Please check all **Requirements** p.7 before beginning instrument operation.

### 4.1. Starting Up the Slide Stainer

Turn on the Slide Stainer using the power button and then turn on the computer.

*Note: It is important to follow this exact power on sequence.*

Double-click the shortcut for the **Oncore Pro Slide Stainer UI**  to access the login screen. Select “Yes” when prompted by Windows User Account Control to grant access permissions. “Do you want to allow this app from an unknown publisher to make changes to your device?”  
*PCStainer.exe*

Login to the main user interface.

Default **User ID:** *Supervisor*

Default **Password:** *Supervisor*

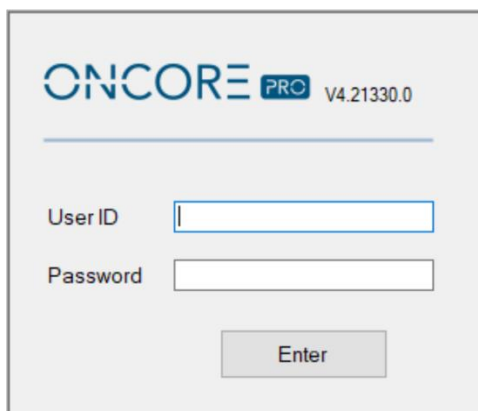

The login screen displays the ONCORE PRO logo and version number V4.21330.0. Below the logo is a horizontal line. Underneath, there are two input fields: 'User ID' and 'Password'. Below the 'Password' field is an 'Enter' button.

Figure 7

Refer to **Security**, p. 80, for information on managing User IDs and Passwords.

Close the door of the Slide Stainer and click “**Enter**” to access the Main screen and begin system initialization.

The system will take a few minutes to verify all connections between the instrument and the computer, and then home the robotic arm, modules, and pumps.

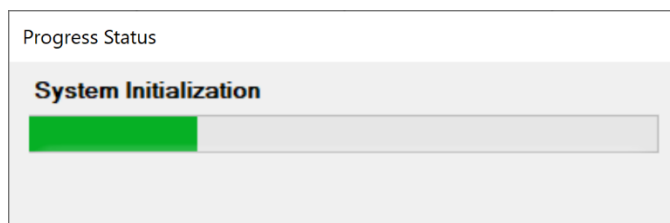

Figure 8

*Tip: If the system fails to start or is stopped/interrupted while performing a task, re-initialize the system and try again. Refer to **Perform System Initialization**, p.50, for more information.*

An interactive slide map corresponding to the 36 slide positions is displayed on the Main screen.

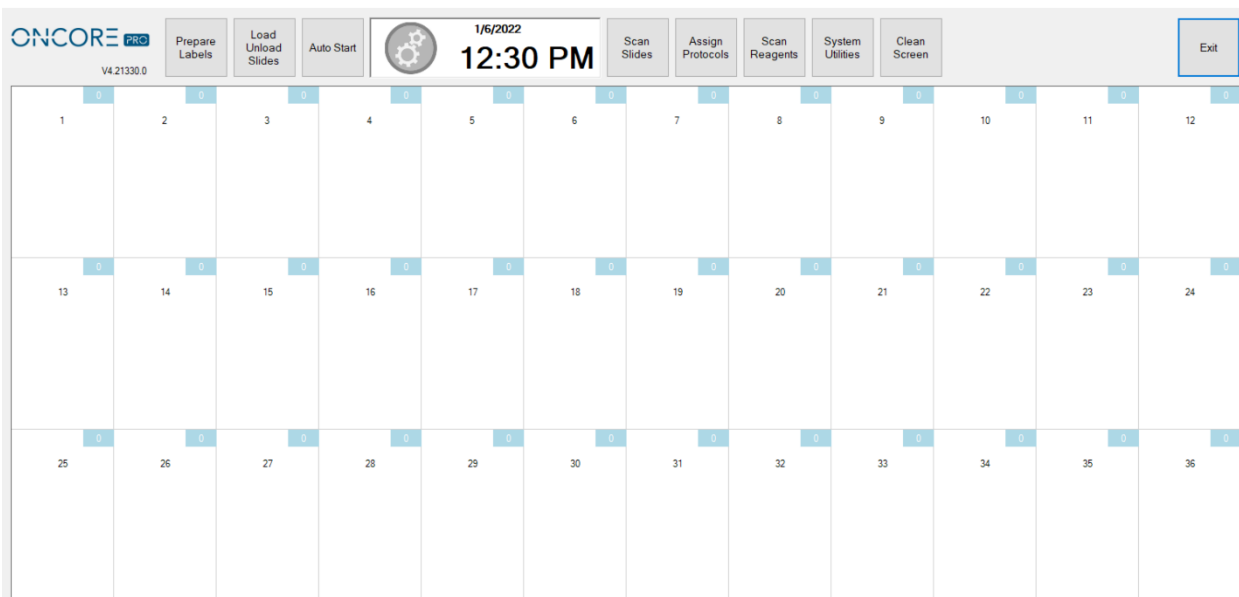

Figure 9

All routine functions are readily accessed from the **Main** screen. To perform a typical run, click:

**Prepare Labels** to print labels for slides. Each label is printed with a 2D barcode required to identify the slide.

**Load/Unload Slides** to lift and lower lids for inserting and removing slides.

**Auto Start** to automatically start the run after loading the labeled slides and tagged reagents.

**Scan Slides** to scan the barcode labels on the slides.

**Assign Protocols** to manually assign a protocol to a slide.

**Scan Reagents** to scan the RFID tags on the reagent vials.

**System Utilities** to access additional features and utility functions.

**Clean Screen** to clear the slide map.

**Exit** to close the application.

## 4.2. Preparing and Printing Labels

From the Main screen, click “**Prepare Labels**” to open the **Slide Label Editor**:

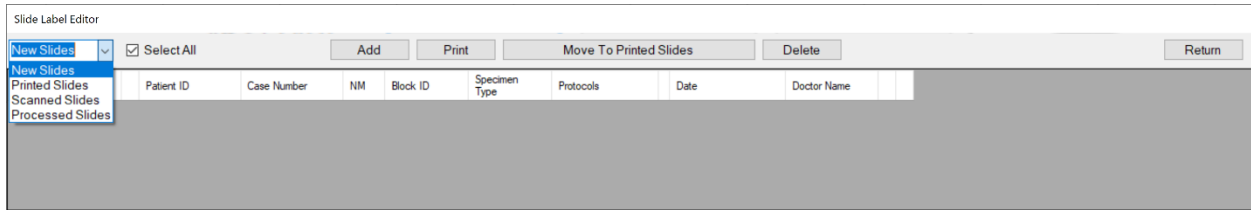

Figure 10

Labels available for printing are listed on the screen under **New Slides**.

- A. Select **New Slides** to create or view new labels.
- B. Select **Printed Slides** to review or reprint a label.
- C. Select **Scanned Slides** to review labels that have already been scanned.
- D. Select **Processed Slides** to review labels that have already been processed.

### Add New Labels in the Barcode Editor

Labels must be prepared in the Barcode Editor and added to the Slide Label Editor before they can be printed.

To add new labels to the Slide Label Editor, click “**Add**” to open the Barcode Editor.

Enter the **Patient ID**, **Case Number**, and other required label information\* into the designated fields.

**⚠ Note:** caret ^ and tilde ~ characters are not permitted in the entry fields.

Figure 11

Next, add protocols to the list of **Selected Protocols**:

(Optional) Select the **Date Time** of the label.

(Optional) Select the name of the **Doctor** from the dropdown list. *To add new names to the list, refer to 2D Barcode Format p. 81.*

(Optional)\* To print the “Block ID” field to the slide label, the user must change the default label format. Select “Container Identifier” from the drop-down list in the desired field of the Label Formatter.

**Note:** The information entered may not be printable due to the size constraints of the label. Use abbreviations as needed or select a different label format. Protocol Name, Patient ID, Date, Case Number, Hospital Name and Description are printed on the label by default. *To change this setting, refer to 2D Barcode Format p.81.*

**To add protocols to the Selected Protocols,** select protocol(s) from the list of Available Protocols and click **“Add”**.  
*Tip: The user may search the list of protocols by typing the first few letters of the protocol name. Click **“Save”** to generate new labels for each protocol in the list of Selected Protocols.*

The screenshot shows the 'Barcode Editor - Add' window. At the top, there are input fields for Patient ID (Patient A), Date Time (12:41:39 PM), Case Number (123456), Block ID (4A), Specimen Type (Tissue X), Doctor (Doctor C), Hospital Name (Hospital F), and Description (test label). A Custom Group dropdown is set to 'None'. Below these are two lists: 'Available Protocols' and 'Selected Protocols'. The 'Available Protocols' list includes items like HPV 6 Probe, Kappa Probe, Ki67 Rb, Lambda Probe, Mammaglobin, MLH-1 Extras, MSH2, MSH6, p40 Extras Special, p63 (highlighted), Pan CK Plus, PAX-5 Extras, PAX8, PR, RNA- Probe, and RNA+ Probe. The 'Selected Protocols' list contains CD20, CK7, and p63. Between the lists are 'Add With:' checkboxes for Positive and Negative, and 'Add' and 'Remove' buttons. 'Save' and 'Return' buttons are at the bottom.

Figure 12

Alternatively, the user may use a customized sublist of available protocols by selecting a custom group from the **Custom Group** drop down list.

The screenshot shows a 'Custom Group' dropdown menu. The menu is open, showing options: 'None' (selected), 'custom group 1', 'custom group 2', and 'custom group 3'.

Figure 13

Refer to **Creating Custom Groups**, p. 78, for more information on creating custom groups

**To remove protocols from the list of Selected Protocols,** select protocol(s) from the list and click **“Remove”**.

**(Optional) To add a positive and/or negative control to the Selected Protocols,** select the protocol and check the boxes **Add With: Positive** and/or **Negative**, and click **“Add”**. Click **“Save”** to generate new labels.

This screenshot is similar to Figure 12 but shows a different state. In the 'Available Protocols' list, 'CD20' is highlighted. In the 'Add With:' section, both 'Positive' and 'Negative' checkboxes are checked. The 'Selected Protocols' list now includes CD20, CD20+, and CD20-.

Figure 14

Refer to **Assigning Negative Controls**, p. 75, for more information on assigning negative controls to protocols.

The screenshot shows the 'Add With:' section of the form. It contains two checkboxes: 'Positive' and 'Negative', both of which are checked.

Figure 15



**(Optional) To add an entire panel of protocols to the Selected Protocols**, select the custom panel from the list of **Available Panels** and click **“Add”**. All protocols assigned to the panel (including positive and negative controls) will be added. Click **“Save”** to generate new labels.

Figure 16

The user must first create a custom panel before the Available Panels field is made visible in Barcode Editor.

Figure 17

Refer to **Creating Custom Panels**, p. 78, for more information on creating Panels.

After saving the current labels, the user may continue preparing labels for the next case. By default, the input patient information is retained in the entry fields for the next set of labels. To change this setting, refer to **2D Barcode Format** p. 81.

Click **“Return”** to close the Barcode Editor.

### Print Labels in the Slide Label Editor

All unprinted label entries are listed under New Slides in the Slide Label Editors. This list is automatically sorted by Patient ID; however, the user may sort the list by the column headers i.e.: Label No., Case Number, Block ID etc.

No.	Patient ID	Case Number	NM	Block ID	Specimen Type	Protocols	Date	Doctor Name	Hospital Name	Description
1	Patient A	123456	1/3	4A	Tissue X	CD20	1/6/2022 12:41 PM	Doctor C	Hospital F	test label
2	Patient A	123456	2/3	4A	Tissue X	CD20	1/6/2022 12:41 PM	Doctor C	Hospital F	test label
3	Patient A	123456	3/3	4A	Tissue X	CD20-	1/6/2022 12:41 PM	Doctor C	Hospital F	test label

Figure 18

**To print labels from the Slide Label Editor**, select the label(s) or **“Select All”** using the checkbox, and click **“Print”**. *Note: Label entries are automatically removed from the system after 30 days from the date assigned on the label.*

**To delete a label from the Slide Label Editor**, select the checkbox and click **“Delete”**. *Note: Once the slide label(s) have been printed, slide processing is initiated and the slide information will be distributed to all instruments on the Network. The label entry can no longer be deleted.*

Refer to **2D Barcode Format**, p. 81, for information on adjusting printer settings and label format.

### Move Slides to Printed Slides (for use with LIS only)

The instrument can be configured to recognize slide labels generated from an external source when integrated with an LIS system. *Note: The 2D Barcode reader must be configured to recognize labels of different formats. Please contact Technical Support for more information.*

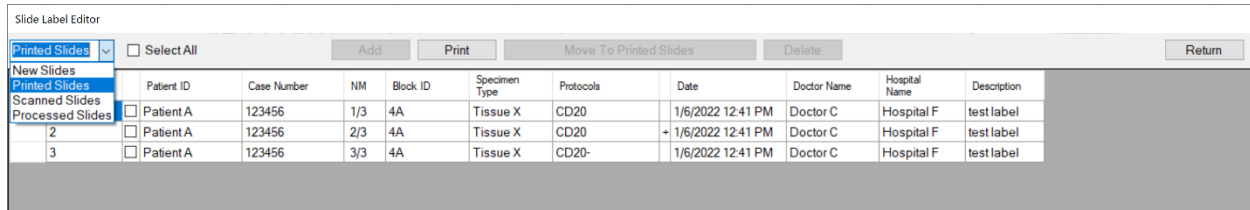

The screenshot shows the Slide Label Editor interface. At the top, there are buttons for 'Printed Slides', 'Add', 'Print', 'Move To Printed Slides', 'Delete', and 'Return'. Below these is a table with columns: Patient ID, Case Number, NM, Block ID, Specimen Type, Protocols, Date, Doctor Name, Hospital Name, and Description. The table contains three rows of data, each with a checkbox in the first column.

	Patient ID	Case Number	NM	Block ID	Specimen Type	Protocols	Date	Doctor Name	Hospital Name	Description
<input type="checkbox"/>	Patient A	123456	1/3	4A	Tissue X	CD20	1/6/2022 12:41 PM	Doctor C	Hospital F	test label
<input type="checkbox"/>	Patient A	123456	2/3	4A	Tissue X	CD20	1/6/2022 12:41 PM	Doctor C	Hospital F	test label
<input type="checkbox"/>	Patient A	123456	3/3	4A	Tissue X	CD20-	1/6/2022 12:41 PM	Doctor C	Hospital F	test label

Figure 19

The LIS system sends the processing order directly to the system computer. The ordered slides will appear under **New Slides** in the **Slide Label Editor**. The user has the option to 1) print the slide label(s) to initiate processing, or 2) directly move slide label(s) to **Printed Slides** to initiate slide processing without printing, or 3) delete the slide labels to cancel the order.

To manually move pre-printed labels to **Printed Slides** (without printing), select the label(s) using the checkbox and click “**Move To Printed Slides**”.

## 4.3. Loading Slides and Installing Chambers

From the Main screen, click “**Load Unload Slides**” to raise all module lids. Peel the labels from the label roll and affix them to the frosted side of the slide. Slides are loaded individually onto each module.

*For slides that must be baked prior to staining, refer to **Prepare Slides with Baking Slides Function** p. 46. Refer to **Slide Specifications**, p. 28, for more information on tissue location recommendations for slides.*

### Load/Unload Slides

Verify that the heating plate and module surfaces are clean and dry before loading a new slide.

**To load a slide onto a module**, insert the slide into the hinge slot and then lower it onto the heating plate until it locks in place under the front clip. If needed, adjust the slide so that it is centered over the heating plate. Click “**Slide Lids Down**” to lower all module lids.

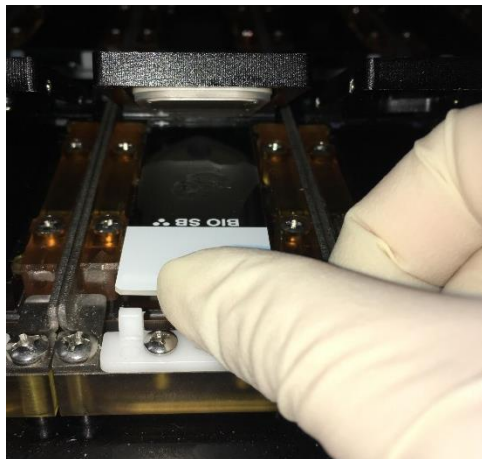

Figure 20

*Tip1: If the slide is too difficult to insert, clean the hinge area to remove any salt or debris.*

*Tip2: The hinge contains springs to accommodate minor differences in slide length. However, if the slide is too long, the front clip can be adjusted by loosening the two screws with a small screwdriver.*

**To unload the slide from a module**, push the slide against the hinge slot until it is released from under the front clip. Carefully lift the slide out, keeping it horizontal to prevent excess buffer from spilling onto the module surfaces.

Transfer the slide to a slide rack and rinse it with distilled water before post treatment.

Wipe the heater, hinge slot, and other affected module surfaces with a moist paper towel to remove any staining residues, then blot dry.

### **Install/Remove Chambers**

Chambers are installed individually onto each module. They should be removed from the module for routine cleaning and inspection to maintain optimal staining quality. Refer to *Daily Maintenance Recommendations*, p. 100, for more information.

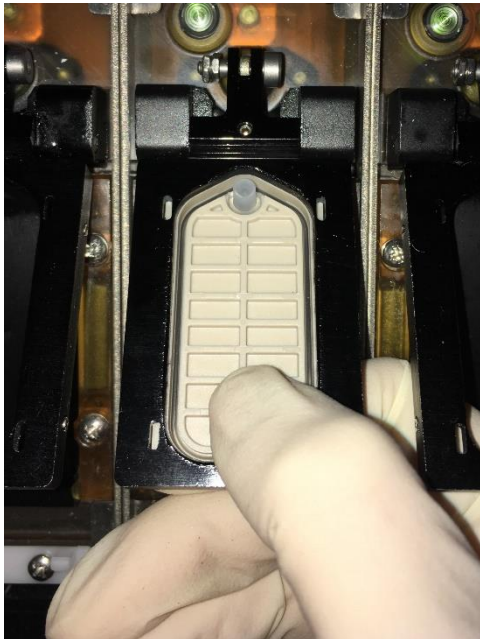
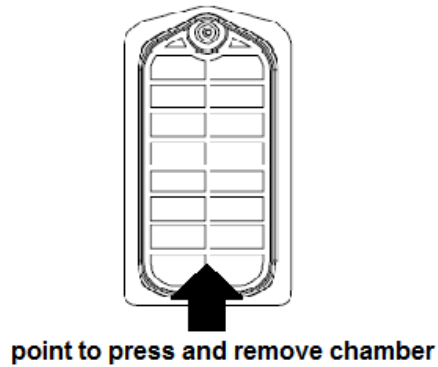

Figure 21



**To install the chamber**, slide the chamber into the recess under the module lid and push up on the chamber until it locks into place. Verify that all 4 corners of the chamber sit flat in place.

*Tip: Push up on the underside of the chamber surface to verify the integrity of the chamber gasket. If the chamber gasket is loose or damaged, it is time to replace the chamber.*

**To remove the chamber**, gently push down on the chamber to unlock it from the module lid. Transfer the chamber to a container for cleaning.

*Tip: After completing a staining run, gently wipe the chamber surfaces with a lint-free alcohol wipe to remove any staining residues/debris that may adhere to the chamber.*

## 4.4. Assigning Protocols: Scan Slides and Manually Assign Protocols

To automatically assign protocols by scanning labeled slides, close the door and click “Scan Slides” on the Main screen. The system will automatically scan all 36 slide positions and assign the protocol(s) of labeled slides to the appropriate position on the slide map. Refer to **Editing Protocols**, p. 68, and **Change Protocol Template**, p. 68, for more information on generating protocols.

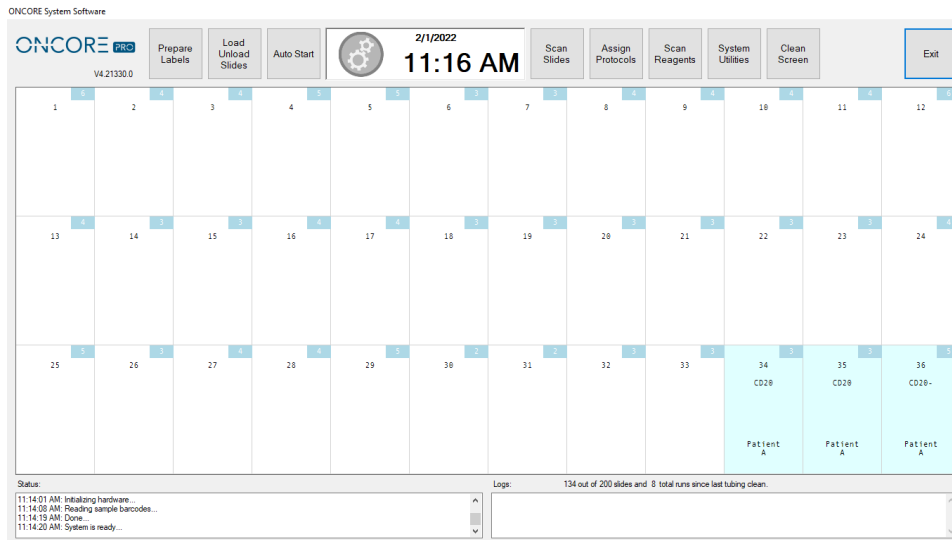

Figure 22

*Tip: Click + drag on the slide map to select specific slide positions to scan.*

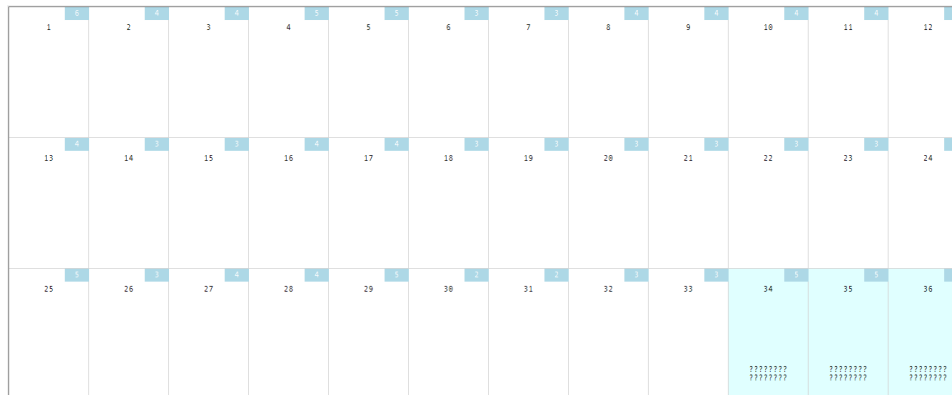

Figure 23

To manually assign protocols to unlabeled slides, click + drag on the slide map to select the slide position(s). The slide position(s) will be highlighted and display “????????”:

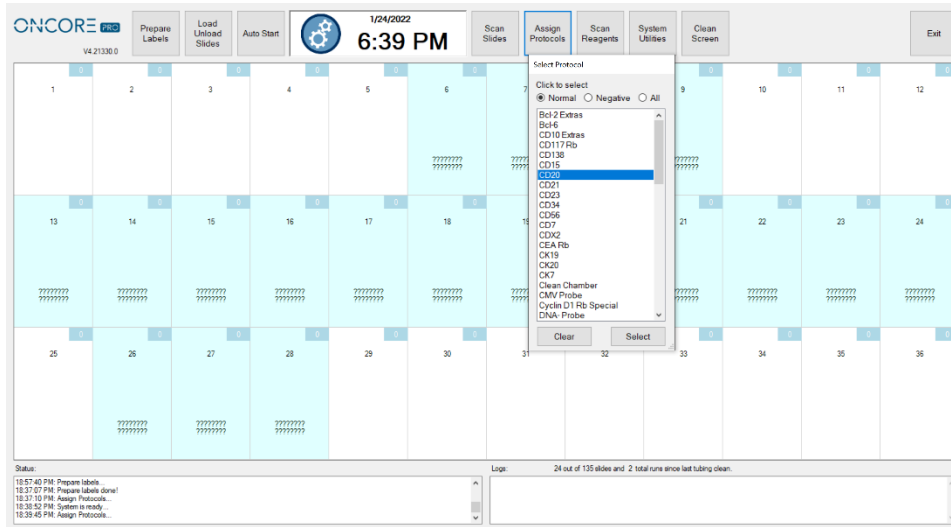

Figure 24

Click “Assign Protocol” to open the **Select Protocol** screen.

- Click to select **Normal** to access the list of normal protocols.
- Click to select **Negative** to access the list of negative control protocols.
- Click to select **All** to access the list of all protocols.

Scroll through the protocol list, highlight the desired protocol, and click “Select” to assign the protocol to the highlighted slides.

*Tip: The user may quickly scroll through the protocol list by typing the first few letters of the protocol name.*

Click “Clear” to cancel the selection and close the window.

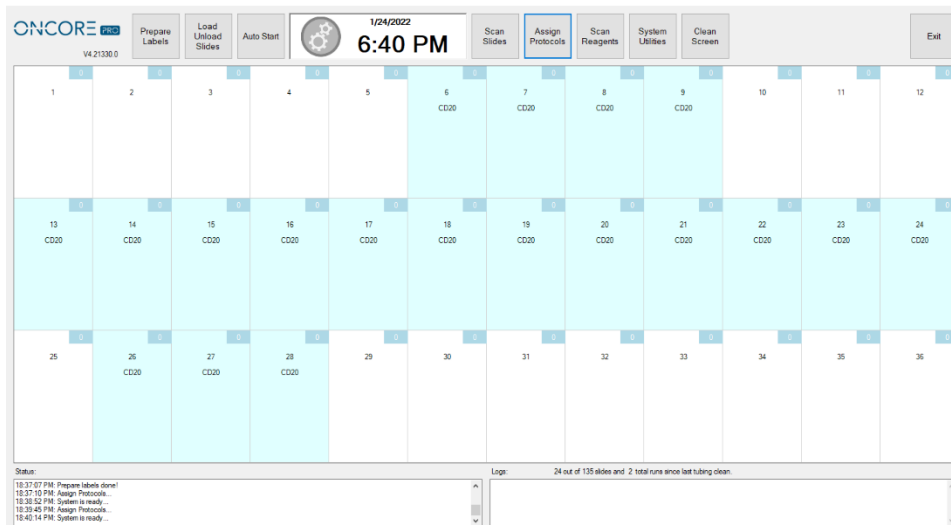

Figure 25

To clear the protocol assignment(s), click + drag to highlight the slide position(s), and then click + drag once more to remove the assignment(s). Alternatively, click “Clean Screen” to clear the entire slide map.

## 4.5. Loading Reagents

Detection kits, ancillary reagents and antibody/probe products are shipped ready-to-use.  
Refer to the manufacturer's Datasheet and SDS for specific instructions.

Prepare all other reagent solutions following the manufacturer's instructions.

*Note: Only Oncore Pro reagent vials are compatible with the instrument. Refer to the vialing specifications in **Vialing Reagents**, p. 28, for additional information on vialing and recommended reagent volumes.*

Load the reagent vials onto the reagent rack and **remove all caps**.

Verify that the vials are fully inserted into the rack and oriented correctly, as shown in the figure below.

- A. For **ready-to-use reagents**, place the reagent in any position on the rack.
- B. For **on-board mixing reagents**, place the two mixing components on the rack, A and B. Avoid placing the second mixing component, B, in the last two rows of the rack as the Z2 probe cannot reach it.

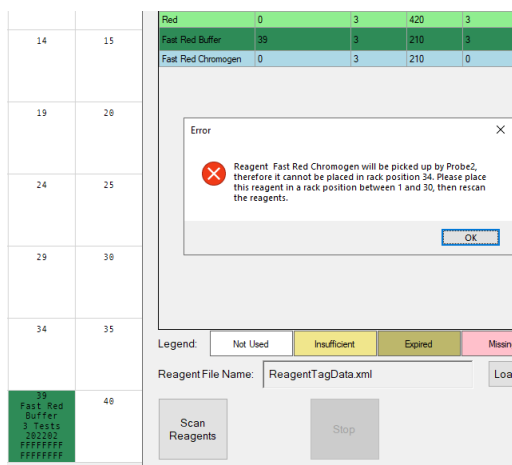

Figure 26

*Note: On-board mixing reagents, such as Fast Red 1:1, are specially formulated to be mixed directly on the slide:*

- A. *The first mixing component, i.e.: Fast Red Substrate, is applied with the Z1 probe.*
- B. *The second mixing component, i.e.: Fast Red Chromogen, is applied immediately afterwards with the Z2 probe.*

The Z2 probe is specially designated for dispensing the second mixing component; therefore, those reagents, such as Fast Red Chromogen, can only be loaded in reagent rack positions #1-30.

- C. For **on-rack mixing reagents**, place all mixing components A and B (and C if applicable) on the rack. Additionally, place an empty mixing vial (7mL or 15mL) in designated position, i.e.: #40, as prompted by the system in the Reagent Check screen.

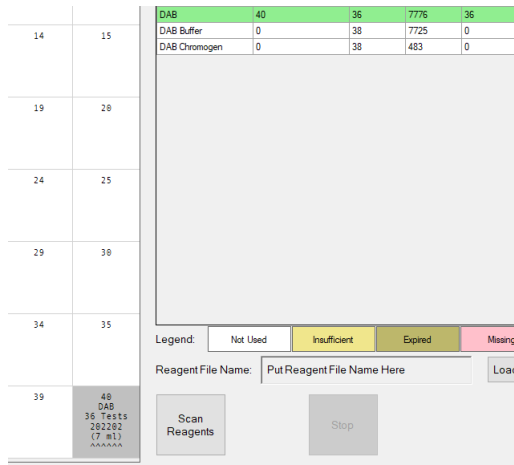

*Note: The system will consume extra tests of each reagent component to fill the dead volume of the empty mixing vial or to fulfill the minimum mixing volume requirement.*

Figure 27

Multiple vials of the same reagent may be placed on the rack. The system will prioritize the use of vials with the earliest expiration date or the least number of tests remaining. Refer to **Reagent Consumption Priority**, p. 85.

Load the reagent rack onto the designated reagent plate on the instrument. Verify that the rack is fully seated on the plate, and is oriented correctly, as shown in the figure below.

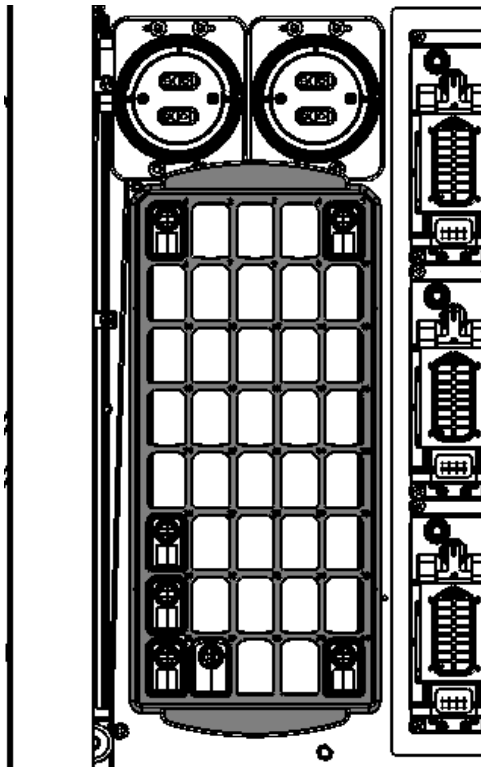



Figure 28

## 4.6. Vialing Reagents

The system provides user-fillable reagent vials for special reagents, uncommon antibodies, and custom ab titers. Each vial is packaged with an RFID tag, cap, and a blank label.

 Use of unauthorized reagents on the system may cause damage to instrument components and will revoke the manufacturer's warranty.

The clear vial option is designated for general use.

The dark vial option is designated for light-sensitive reagents such as probes and chromogens.

Contact Customer Service for ordering information.

### 7mL Reagent Vial Specifications

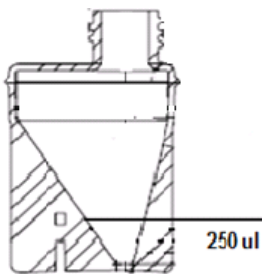

Figure 29.

The **7mL** vial is specially designed for efficient use of antibodies and probes by minimizing dead volume.

Max capacity 9mL.

The **dead volume** for a 7mL vial is ~250uL.

*Note: Although the 7mL vial can hold up to 9mL, it is recommended to fill below 7.5mL to avoid triggering liquid volume errors.*

### 15mL Reagent Vial Specifications

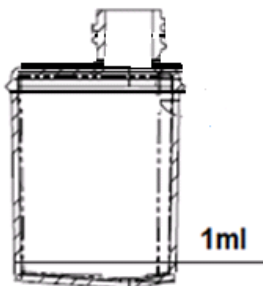

Figure 30

The **15mL** vial is designed to hold larger volumes of reagent.

Max capacity 16mL.

The **dead volume** for a 15mL vial is ~1000uL.

### Instructions for Use

Fill the reagent vial with the appropriate amount of reagent solution.

*Tip: Use the Reagent Check screen to quickly obtain a list of required reagent volumes, then add 1mL dead volume for a 15mL vial or add 250uL for a 7mL vial.*

#### To calculate the required volume:

**Volume = number of tests x protocol volume x draw factor 1.08\* + dead volume of the vial**

*Note\*: An additional 8% extra volume (or more) is required to compensate for reagent evaporation and amount adhering to the internal surface of the tubing and external surface of the aspiration probe.*

Label the reagent vial and cap.

Program the RFID tag. Refer to **Preparing RFID Reagent Tags with the RFID Tag Editor**, p. 75, for more details.

*Note: Some reagents are listed under multiple reagent types i.e.: AP and HRP. Select from any one of the applicable Reagent Type categories in the RFID Editor to program the RFID tag.*



## 4.7. Managing Buffer and Waste

The system will prompt the user to verify the required Wash Buffer and Waste Container volumes before proceeding with the staining run.

### Refill the Wash Buffer Container

The standard Wash Buffer Container has a maximum capacity of 2000mL.

The buffer container is stored on the inner left housing structure.

Click System Utilities>Tools>”**Move Arm to Middle**” to safely move the robotic arm aside to access the buffer.

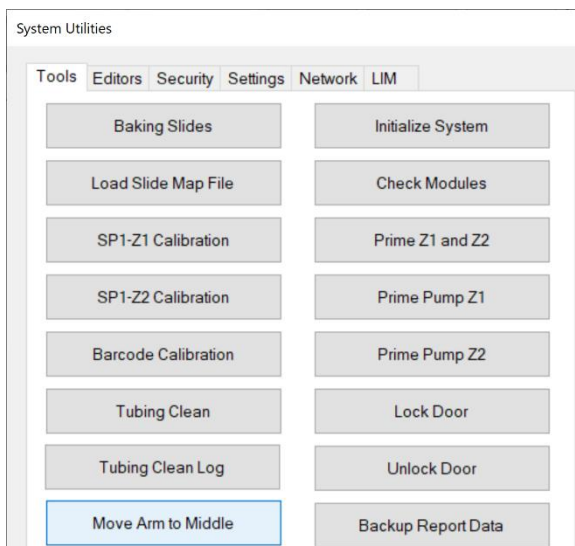

Figure 31



Figure 32

Disconnect the buffer container and carefully remove it from the instrument. Avoid making contact with the robotic arm or deforming the buffer adapter tubing.

Refill the container with fresh buffer, then reconnect the buffer container and place it back onto the instrument. Clean up any leaks or spills.

Click System Utilities>Tools>”**Prime Z1 and Z2**” to prime the inline tubing, then visually inspect the lines to ensure that air bubbles are not present.

## Empty the Waste Containers

The standard Waste Containers have a maximum capacity of 4000mL, with a secondary containment provided for each waste container.

The waste containers are stored underneath the instrument, fed by gravity through the waste tubing. Click System Utilities>Tools>”**Move Arm to Middle**” to safely move the robotic arm aside from the waste stations. Carefully pour some water through the waste stations to flush out the waste tubing.



Figure 33

Disconnect the tubing from the Waste Container caps and empty the waste containers. Dispose of the waste according to local regulations.

Reconnect the waste tubing: the black tubing is designated for hazardous waste and the blue tubing is designated for non-hazardous waste.

Verify that the waste tubing is draining properly, making sure that the inserted end of the tubing clears the maximum waste level line. Adjust the angle and free length of the tubing as needed.

## 4.8. Reagent Check: Scan Reagents

  **Remove all reagent vial caps before proceeding.**

From the Main screen, click “Scan Reagents” to open the **Reagent Check** screen. The reagent map is displayed on the left and a table of reagents required for the run is displayed on the right.

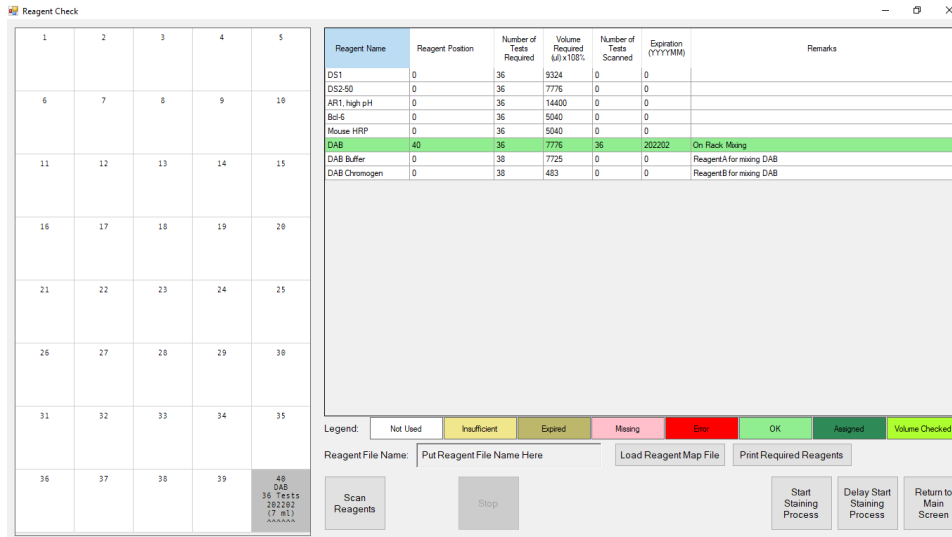

Reagent Name	Reagent Position	Number of Tests Required	Volume Required (ul) x 100%	Number of Tests Scanned	Expiration (YYYYMM)	Remarks
DS1	0	36	5324	0	0	
DS2-50	0	36	7776	0	0	
AR1, high pH	0	36	14400	0	0	
Bcl-6	0	36	5040	0	0	
Mouse HRP	0	36	5040	0	0	
DAB	40	36	7776	36	202202	On Rack Mixing
DAB Buffer	0	38	7725	0	0	ReagentA for mixing DAB
DAB Chromogen	0	38	483	0	0	ReagentB for mixing DAB

Figure 34

*Tip: Click “Print Required Reagents” to print the list of required reagents. A network or USB printer is required.*

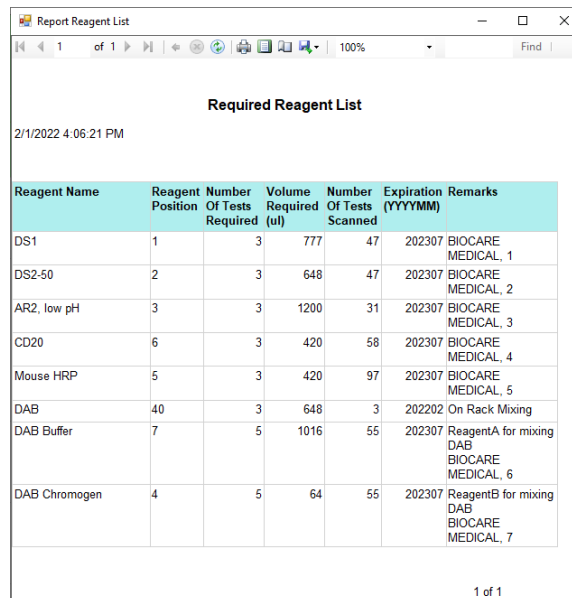

Reagent Name	Reagent Position	Number Of Tests Required	Volume Required (ul)	Number Of Tests Scanned	Expiration (YYYYMM)	Remarks
DS1	1	3	777	47	202307	BIOCARE MEDICAL, 1
DS2-50	2	3	648	47	202307	BIOCARE MEDICAL, 2
AR2, low pH	3	3	1200	31	202307	BIOCARE MEDICAL, 3
CD20	6	3	420	58	202307	BIOCARE MEDICAL, 4
Mouse HRP	5	3	420	97	202307	BIOCARE MEDICAL, 5
DAB	40	3	648	3	202202	On Rack Mixing
DAB Buffer	7	5	1016	55	202307	ReagentA for mixing DAB BIOCARE MEDICAL, 6
DAB Chromogen	4	5	64	55	202307	ReagentB for mixing DAB BIOCARE MEDICAL, 7

Figure 35

To scan all reagents with the RFID reader, close the door and click “Scan Reagents”. The robotic arm will move the RFID reader antenna over each reagent vial position and read out the stored RFID tag information. The system will continue scanning until all required reagents have been detected or all 40 positions have been scanned.

Tip1: Click + drag to select specific reagent vial positions to scan.

Tip2: Click “Stop” to stop the scan while it is in progress.

Figure 36

The scanned reagent assignments are displayed on the reagent map on the left.

Each scanned reagent vial will be displayed with the following:

- Reagent name.
- Number of tests remaining. Updates during the staining process each time reagent is aspirated.
- Expiration date.
- Unique RFID tag ID. Provides traceability for the individual reagent vials across different runs.

After completing the scan, the system will display the current status of the reagents:

- All **expired** reagents are highlighted in **brown** and must be replaced.
- All **missing** reagents are highlighted in **pink** in the reagent list.
- All reagents with **insufficient** number of tests are highlighted in **yellow**.
- All reagents **ready** for the staining run are highlighted in **green**.
- All reagents **not used** will remain with a white background.
- All RFID tags that produced an error during scanning are highlighted in **red** and must be replaced.

Reagent Name	Reagent Position	Number of Tests Required	Volume Required (µl) (100%)	Number of Tests Scanned	Expiration (YYYYMM)	Remarks
DS1	0	3	777	0	202307	
DS2-50	2	3	648	50	202307	BIOCARE MEDICAL_2
AR2_low pH	3	3	1200	34	202307	BIOCARE MEDICAL_3
CD20	4	2	280	1	202307	BIOCARE MEDICAL_4
Mouse HRP	5	3	420	100	202307	BIOCARE MEDICAL_5
DAB	40	3	648	3	202202	On Rack Missing
DAB Buffer	0	5	1016	0	0	Reagent for missing DAB
DAB Chromogen	0	5	64	0	202307	Reagent for missing DAB
Universal Negative	10	1	140	100	202307	BIOCARE MEDICAL_8

Figure 37

The user must add additional vials when the reagent is insufficient or missing. Up to 5 vials of the same reagent may be placed on the rack. Manual assignment or a re-scan of the reagent rack is required to proceed.

*Note: A warning will appear when insufficient reagent is detected. Additional tests may be added either by 1) refilling the reagent vial and reprogramming the test number, or 2) adding additional vials of reagent. Upon re-scan, the reagent will highlight in green once the test number is found to be sufficient.*

The user may need to reprogram or replace the RFID tag when the reagent is not scanned properly. In such circumstances, users must manually verify the volume remaining in the vial to determine the actual number of tests left.

- Not Exist. The scanned reagent name does not exist in the system.
- Data Read Error. The RFID tag failed to scan correctly.
- Tag Not Updated. The RFID tag information was not updated correctly in the previous run.
- RFID tag is not found. The RFID tag failed to scan completely.

*Note: Contact Technical Support for help troubleshooting recurrent cases of RFID misreading or failure, as this may indicate an issue with the system's RFID Reader system.*

For more information on reading and writing RFID tags, refer to **Preparing RFID Reagent Tags with the RFID Tag Editor** p. 75.

To manually assign a missing reagent to the Reagent Map, select the missing reagent in the table on the right, then click a position on the reagent map to assign the exact number of tests required to this reagent rack position.

**⚠ Note:** The user has the capability to manually assign missing or insufficient reagents; however, it is recommended to reserve its use only in the case of an RFID reader or RFID tag failure. Manually assigned reagents cannot be tracked by the system, so it will be the user's responsibility to keep track of the vial contents and gauge the number of tests remaining.

The screenshot shows the 'Reagent Check' window. On the left is a 4x5 grid representing a reagent rack. The top row (positions 1-5) is highlighted in dark green, indicating manually assigned reagents. The table on the right lists reagents with their positions, required and scanned test counts, and expiration dates. A legend at the bottom identifies colors: Not Used (grey), Insufficient (yellow), Expired (orange), Missing (red), Error (dark red), OK (green), Assigned (dark green), and Volume Checked (light green). Buttons for 'Scan Reagents', 'Stop', 'Load Reagent Map File', 'Print Required Reagents', 'Start Staining Process', 'Delay Start Staining Process', and 'Return to Main Screen' are visible.

Reagent Name	Reagent Position	Number of Tests Required	Volume Required (µl) x100%	Number of Tests Scanned	Expiration (YYYYMM)	Remarks
DS1	1	3	777	3	202302	N/A, Manually Assigned
DS2-50	2	3	648	50	202307	BIOCARE MEDICAL_2
AR2_low pH	3	3	1200	34	202307	BIOCARE MEDICAL_3
CD20	4, 13	2	280	2	202302	BIOCARE MEDICAL_4 N/A, Manually Assigned
Mouse HRP	5	3	420	100	202307	BIOCARE MEDICAL_5
DAB	40	3	648	3	202302	On Rack Missing
DAB Buffer	11	5	1016	5	202302	Reagent A for missing DAB N/A, Manually Assigned
DAB Chromogen	12	5	54	5	202302	Reagent B for missing DAB N/A, Manually Assigned
Universal Negative	10	1	140	100	202307	BIOCARE MEDICAL_8

Figure 38

The manual assignments will be saved until the reagent rack is scanned again.

G. All manually added reagents are highlighted in dark green.

**STOP ⚠** Always verify that the manually assigned reagent is placed in its corresponding position on the Reagent Rack and that it has sufficient volume before proceeding.

To review a previously run Reagent Map, click "Load Reagent Map File", and select the map file from the list of reagent map logs. Each log is labeled with the date and time of the run. Open the log and it will be displayed on the reagent map on the left.

This screenshot shows the 'Reagent Check' window with a file explorer window open over it. The file explorer is displaying the 'Logs' folder, listing various XML files named 'ReagentTagData-2021-11-16-03-39-End.xm...' with their respective dates and times. The 'Reagent Check' window in the background shows a reagent map grid where the top row (positions 1-5) is highlighted in dark green. The table on the right shows that all reagents in this row have 0 tests scanned. The legend and control buttons are also visible.

Figure 39

## 4.9. Starting the Run

To immediately start the run, close the door and click “Start Staining Process” from the Reagent Check screen.

 Verify that all caps have been removed from the reagent vials before starting the staining process.

 **Close the door before starting the run.** The door will lock and block unsafe access to the instrument while it is in operation. The staining run will not proceed while the door is open.

The system will initialize and lock the door, then proceed to calculate the most efficient schedule to complete the staining run. Longer protocols are prioritized over shorter protocols to enable the slides to finish at a similar time.

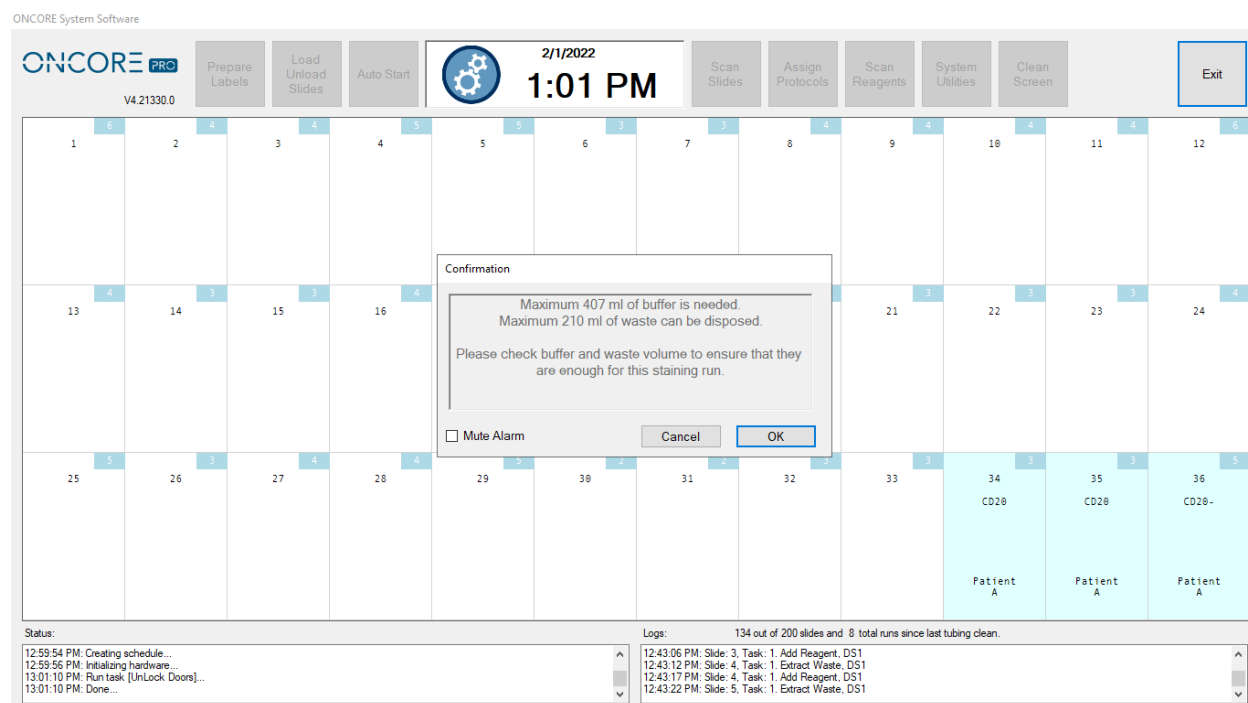

ONCORE System Software

ONCORE PRO V4.21330.0

2/1/2022 1:01 PM

Prepare Labels Load Unload Slides Auto Start Scan Slides Assign Protocols Scan Reagents System Utilities Clean Screen Exit

Confirmation

Maximum 407 ml of buffer is needed.  
Maximum 210 ml of waste can be disposed.  
Please check buffer and waste volume to ensure that they are enough for this staining run.

Mute Alarm Cancel OK

Status: 12:59:54 PM: Creating schedule... 12:59:56 PM: Initializing hardware... 13:01:10 PM: Run task [UnLock Doors]... 13:01:10 PM: Done...

Logs: 134 out of 200 slides and 8 total runs since last tubing clean. 12:43:06 PM: Slide: 3, Task: 1. Add Reagent, DS1 12:43:12 PM: Slide: 4, Task: 1. Extract Waste, DS1 12:43:17 PM: Slide: 4, Task: 1. Add Reagent, DS1 12:43:22 PM: Slide: 5, Task: 1. Extract Waste, DS1

Figure 40

Once all calculations are complete, the system will unlock the door and prompt the user to verify the volume of in-line wash buffer and the remaining waste capacity.

- A. The robotic arm will automatically move to the center of the instrument to allow the user to add more buffer if needed.
- B. The waste containers are located under the instrument work surface and should be emptied as needed.  
*Note: The calculated waste volume reflects the total volume of waste, combining both hazardous and non-hazardous waste. In the event of an overflow of the non-hazardous waste station, all waste will be dispensed into the hazardous waste container. Therefore, it is important to ensure that both waste containers have sufficient capacity.*

Refer to *Managing Buffer and Waste*, p.29, for more information.

**Click “OK” to proceed with the staining process.**

 **The staining process will not proceed until the user completes this verification step.**

As the instrument prepares to start the run, the system will prime each pump three times over the wash stations to fill the in-line tubing. A run timer will appear at the top of the screen, counting down the expected time remaining until the end of the run.

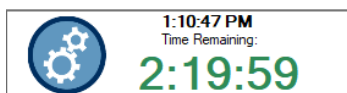

Figure 41

*Tip: Runtime will vary depending on the protocol template(s) used and the run complexity (number of slides and types of protocols selected). Selecting more slides and several protocols running multiple detection systems will result in a longer runtime. To increase overall lab throughput, it is recommended to run shorter runs during the day and save longer, more complex runs for overnight.*

To delay the start of the run to a later date or time, click “Delay Start Staining Process” from the Reagent Check screen:

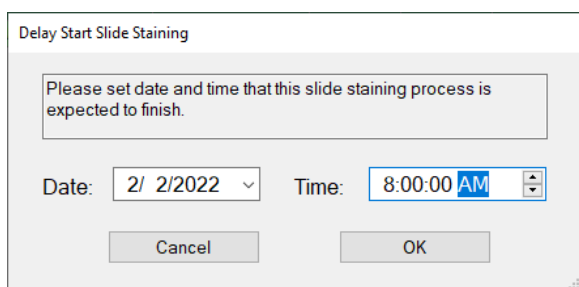

Figure 42

Enter the **Date** and **Time** that the run is expected to finish. The maximum delay start is 72 hours.

The system will calculate the delay time and initiate a countdown. When **Time Left to Start** reaches **0:00:00**, the system will automatically begin the staining process.

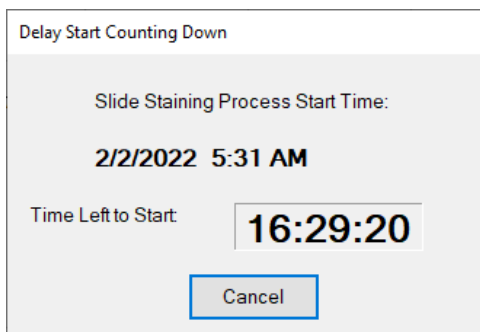

Figure 43

*Tip: Use Delay Start on overnight runs to prevent processed slides from drying out.*



## Gantt Chart

The current run schedule is displayed on the Gantt chart. This may aid in tracking the progress of the run and determining the wait time for loading/unloading slides.

To view the Gantt chart, expand the AutoStainer Server window from the taskbar and click the Gantt tab.

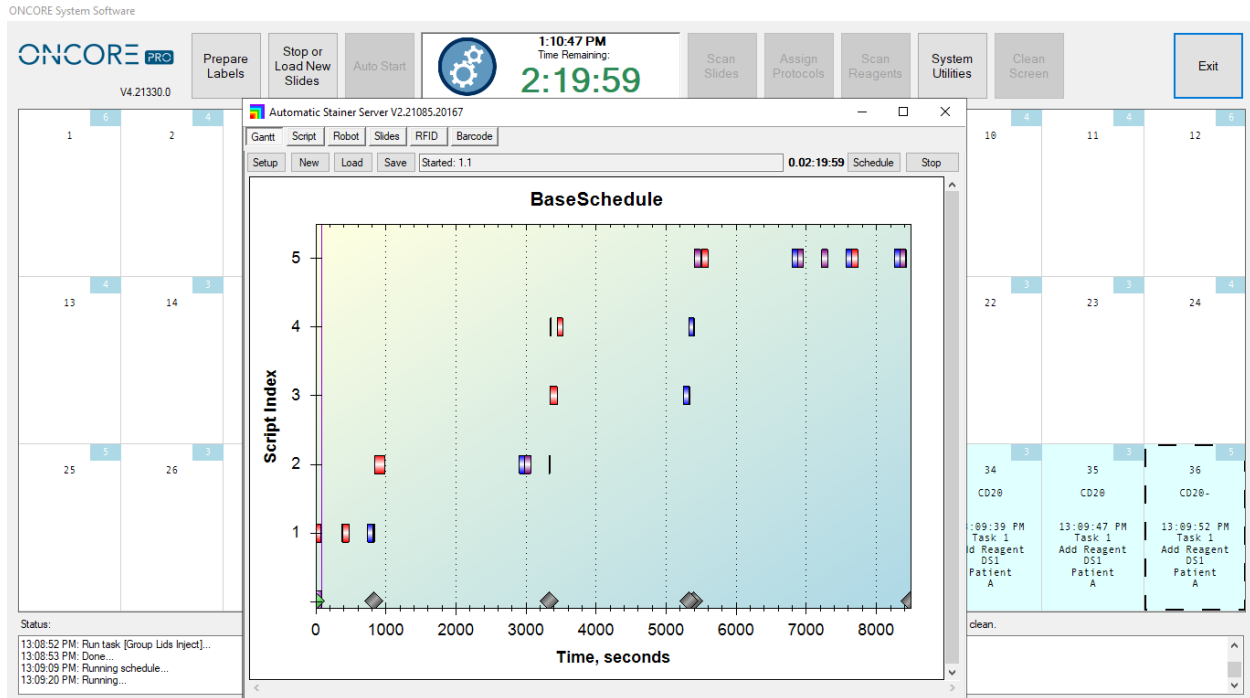

Figure 44

The purple line tracks the progress of the staining run. The time is measured in thousands of seconds.  
*Tip: Hover the mouse over the bar to display the name of the task within the protocol.*

Each bar represents a batched task for a group of slides. The maximum group size is 18.

- 1) The red bar represents a task corresponding to a reagent addition.
- 2) The blue bar represents a task corresponding to a quick wash using wash buffer.
- 3) The green bar represents a task corresponding to a quick wash using a reagent
- 4) The purple bar represents a task corresponding to an incubated wash.
- 5) (Special) The brown bar represents two linked tasks for mixing of 2 RTU reagents.

Sequential tasks are arranged horizontally on the Gantt chart following the sequence of steps in the staining protocol. One or more tasks may be running simultaneously within the course of the staining run, based on the grouping of the slides and protocols. Simultaneously running tasks (from different groups of slides) are arranged vertically on the Gantt chart.

## 4.10. Auto Start

The Auto Start feature may be used to start the staining process directly from the Main screen. The system will automatically proceed from scan slides to scan reagents and skip the buffer and waste verification step to immediately start the run. This may reduce instrument startup time.

This feature requires certain setup conditions for use:

- A. The user has loaded all slides onto the instrument and labelled with a 2D barcode.
- B. The user has loaded all required reagents onto the instrument and programmed the vials with RFID tags.
- C. The user has verified that the buffer volume and waste capacity are sufficient.

**To use Auto Start**, close the door and click “**Auto Start**” on the Main screen and enter the number of slides loaded onto the instrument.

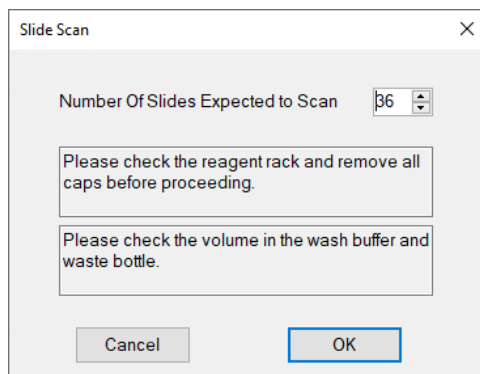

Figure 45

## 4.11. Completing a Run

The system will remain locked while the staining run is in progress. Limited access is provided to prepare labels.

**⚠ In the case of an emergency, click “Exit” to abort the staining run. All run progress will be lost.**

Please heed the following precautions while the run is in progress:

**⚠ Disable Wi-Fi and local internet connection.**

**⚠ Do not attempt to log in/out of Windows or switch users while the instrument is still in operation.** This will cause a fatal system error and cause the system to crash.

**⚠ Do not attempt to run other applications in the background when the instrument is in operation** i.e.: Team Viewer/remote control session, Windows Update, Internet Explorer, Antivirus etc., as it may result in an unexpected system crash.

**⚠ Do not attempt to change file/folder settings or screen display/appearance settings when the instrument is in operation** i.e.: locking the Taskbar, as it may result in an unexpected system crash.

**⚠ The Autostainer Server, Robot, Slide Processor, and RFID Processor Terminals** will be running while the instrument is in operation. Do not attempt to close any of these applications as it may result in an unexpected system crash.



Figure 46

## Runtime Monitoring

While the instrument is running, the user may track the progress of the run from the Main screen. The slide map displays all 36 slides and displays the protocol, time, and the current step at each slide position. A system log is displayed at the bottom of the screen.

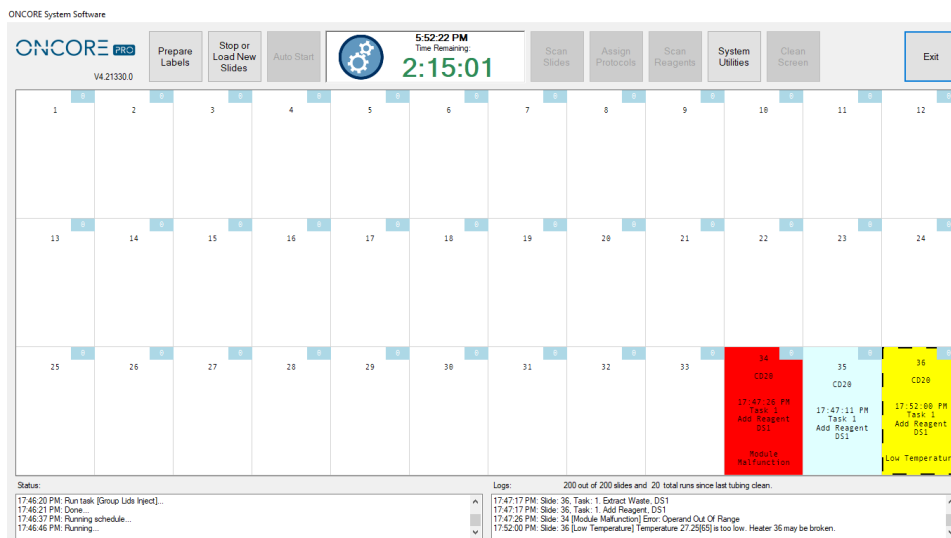

Figure 47

The system monitors the instrument for errors during the staining process. If it encounters any notable errors during its operation, it will attempt to recover from the error and proceed to the next step. Any slide(s) that may have been affected by the error will be marked in **yellow** and labeled with the step in which the first error occurred. The user is advised to verify the staining results of potentially affected slides and review the Slide Report. *Please contact Technical Support if encountering persistent system errors.*

- A. The system monitors the heater temperature during the staining process. If a heater fails to heat or cool down to the temperature set point, its position on the slide map will be marked in **yellow** and display a “**Low Temperature**” or “**Overheating**” warning. The user is advised to perform a heater check after the run to verify the heater function. *Refer to **Check for Module Malfunction**, p. 50, for more information.*
- B. The system monitors the module function during the staining process. If a module fails, its position on the slide map will be marked in **red** and display a “**Module Malfunction**” warning. The module will be disabled and cannot be used again until the error has been cleared. The user is advised to perform a module check after the run to verify the module function. *Refer to **Check for Module Malfunction**, p. 50, for more information.*
- C. The system verifies the liquid level in the reagent vial before drawing reagents. The Z1 probe is equipped with a liquid level sensor. If a low volume or no liquid is detected, the system will mark all affected slides **yellow** with a “**Low Volume**” warning. The user is advised to verify the volume in the reagent vial(s) after the run to verify the error and identify potentially affected slides. Reagents that have low conductivity or high viscosity cannot be reliably detected by the liquid level sensor. The system may show a low volume warning for such reagents. In this case, the user may visually inspect the reagent vials to confirm that sufficient volume was available during the staining run.
- D. (If the Overflow Detection option is enabled), the system verifies the liquid level in the waste overflow bin before dispensing waste. If liquid is detected, the system will alert the user of a potential overflow. When an overflow is detected in the non-Hazardous waste, the system will automatically switch over to use the

Hazardous Waste to prevent further overflow. The user is advised to verify that the waste tubing is draining properly and/or empty the waste container(s).

## End of Run

The system will highlight the slides that have successfully completed staining in light green and mark as **“Finished”**.

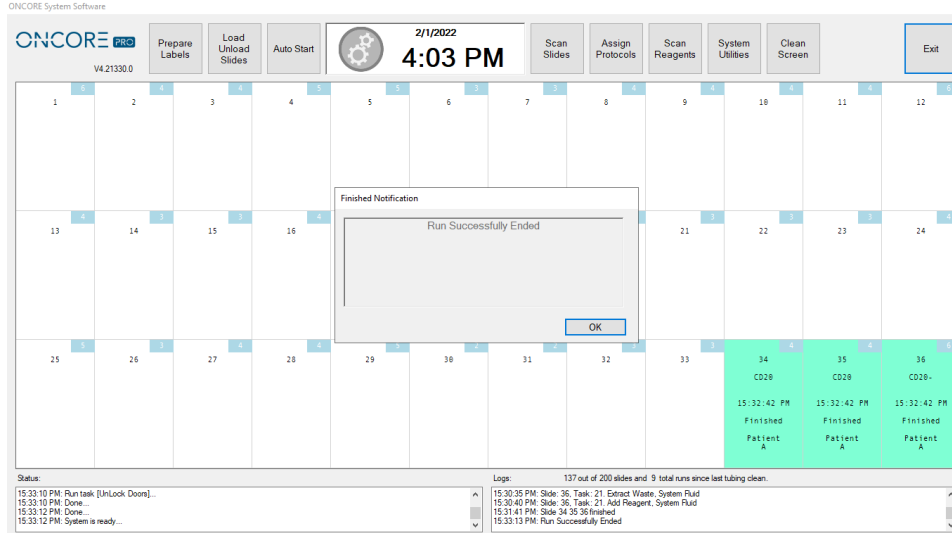

Figure 48

After completing the final step of the run, the system will prime both pumps to clean the syringes, unlock the door and prompt the user: **“Run Successfully Ended”**. The slide chambers are filled with wash buffer during the last step of the staining protocol to prevent the slides from drying out before they are unloaded from the system.

However, if an error or warning was encountered during the run, the system will instead prompt the user: **“Run Ended with Warnings”**.



Figure 49

The user can review the slide map and report data to identify the slide(s) which may have been affected by the error. Refer to **Section 6: Reports**, p. 90, for more information.

**⚠** Do not close any UI applications or shut down the instrument before the seeing the **Finished Notification** message. The instrument may still be in operation.

## Aborting a Run

If the system encounters an irrecoverable error, it will immediately abort the staining process.

The aborted slides will be highlighted in **orange** or **yellow** and the system will prompt the user: “Run Aborted Due to Script Error”. The staining run progress cannot be recovered upon system abort.

 **Contact Technical Support immediately to verify that the system abort is not caused by a serious issue on the instrument.**

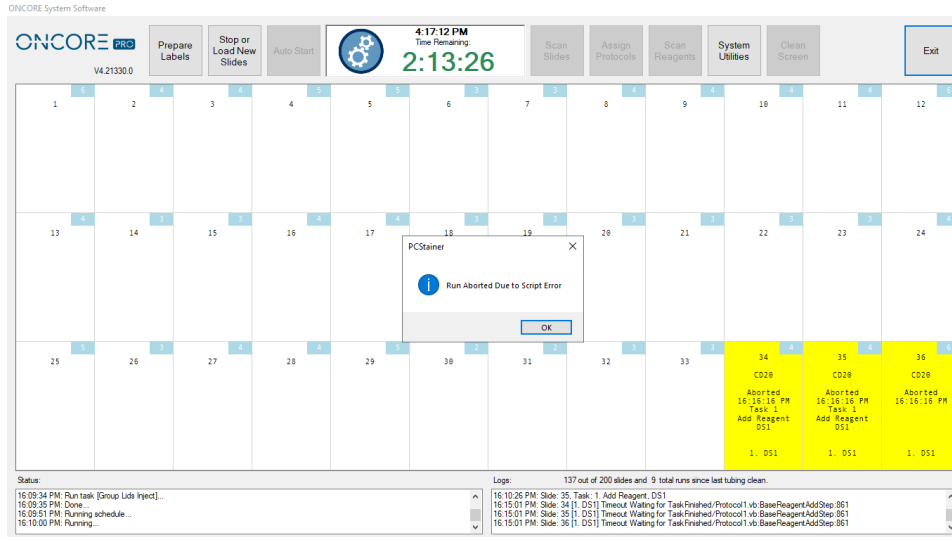

Figure 50

*Note: In an emergency case, the user may manually abort the staining process.*

*Click “Exit” to close the main interface or power off the system to immediately stop the instrument.*

## 4.12. Continuous Loading

The Continuous Loading feature allows users to load more slides after the staining process has already started.

*Note: Using this feature may significantly increase the total run time and delay the finish time for all remaining slides in the run. This feature should not be used for time sensitive reagents such as Fluorescence In-situ Hybridization (FISH). Please call Technical Support for further assistance.*

### Stop the Current Run

To stop the current run, click “Load New Slides”. The system will stop the progress of each slide as it reaches a safe stopping point in its staining protocol. The wait times will vary for each circumstance.

The screenshot shows the ONCORE System Software interface. At the top, there are buttons for 'Prepare Labels', 'Stop or Load New Slides', 'Auto Start', 'Scan Slides', 'Assign Protocols', 'Scan Reagents', 'System Utilities', 'Clean Screen', and 'Exit'. The time remaining is 2:19:27. Below the buttons is a grid of 36 slides (6 rows by 6 columns). Slides 1, 2, and 3 are highlighted in light blue and contain text: 'CD28', '18:07:12 PM Task 1 Add Reagent D51 Patient B', '18:07:19 PM Task 1 Add Reagent D51 Patient B', and '18:07:25 PM Task 1 Add Reagent D51 Patient B'. A warning dialog box is centered over the grid, with the text: 'Warning: To avoid compromising the staining results, the system must stop each slide at a safe point. Depending on the schedule, the system may take a long time to stop. Do you want to continue?'. The dialog has 'Yes' and 'No' buttons. At the bottom, there is a 'Status' section with a scrollable list of events and a 'Logs' section with a scrollable list of system logs.

Figure 51

After the system has stopped the progress of all slides, the door will unlock and a popup message will alert the user “Run Successfully Stopped”. The slides that have been stopped will be highlighted in light coral and marked “Stopped”.

The screenshot shows the ONCORE System Software interface. At the top, there are buttons for 'Prepare Labels', 'Load Unload Slides', 'Auto Start', 'Scan Slides', 'Assign Protocols', 'Scan Reagents', 'System Utilities', 'Clean Screen', and 'Exit'. The time remaining is 6:21 PM. Below the buttons is a grid of 36 slides (6 rows by 6 columns). Slides 1, 2, and 3 are highlighted in light coral and contain text: 'CD28', '18:20:24 PM Task 4 Wash System Fluid Patient B', '18:20:24 PM Task 4 Wash System Fluid Patient B', and '18:20:24 PM Task 4 Wash System Fluid Patient B'. A 'Finished Notification' dialog box is centered over the grid, with the text: 'Run Successfully Stopped'. The dialog has an 'OK' button. At the bottom, there is a 'Status' section with a scrollable list of events and a 'Logs' section with a scrollable list of system logs.

Figure 52

**⚠ Never exit the Main screen after the run has been stopped. The progress on all stopped slides will be deleted and cannot be recovered.**

### Restart the Run

Prepare and load new slides. The system will automatically lift the lids of all available slide positions, including empty positions and positions marked as “Finished”. The positions marked as “Stopped” will be set at the lid Down position and those slides cannot be unloaded from the instrument.

**⚠ Unload all Finished slides before loading any additional slides.**

Scan the new slides to automatically assign the protocols, or manually assign new protocols to the available slide positions. The positions marked as “Stopped” are locked and cannot be assigned a new protocol.

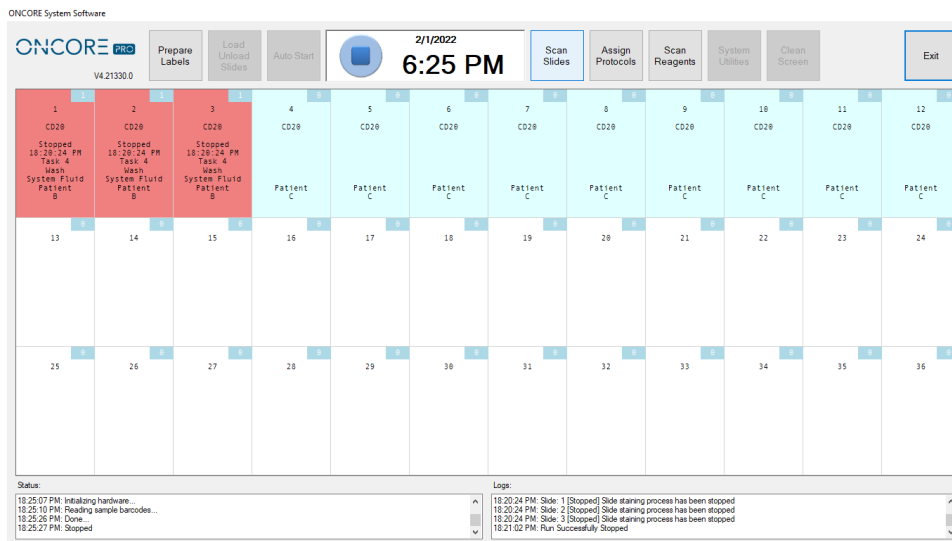

Figure 53

Load any additional reagents that may be required by the new slides and re-scan the reagent rack.

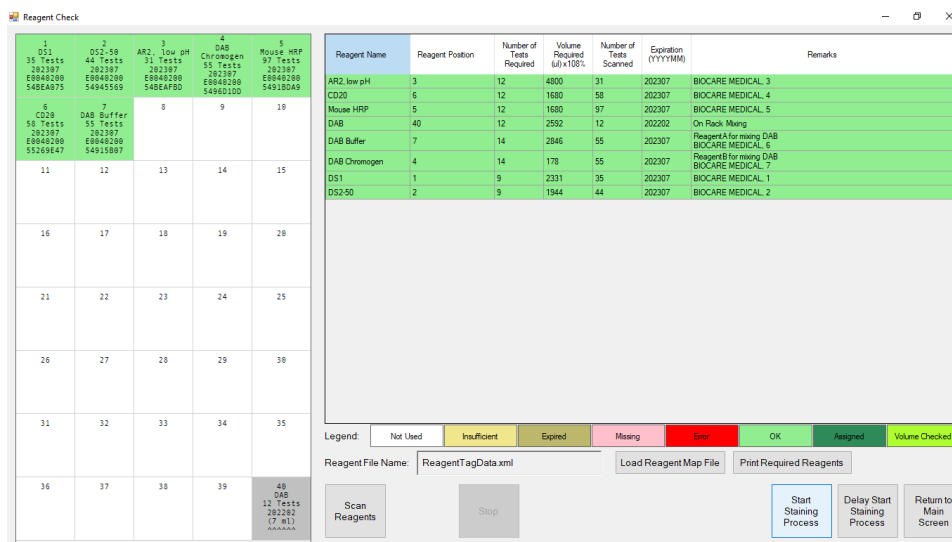

Figure 54

Re-start the staining process. The system will reschedule the run to incorporate the new slides. The new slides will take priority and will run separately until they catch up with the Stopped slides. The Stopped slides will resume progress when the new slides have reached the same point as the Stopped slides.

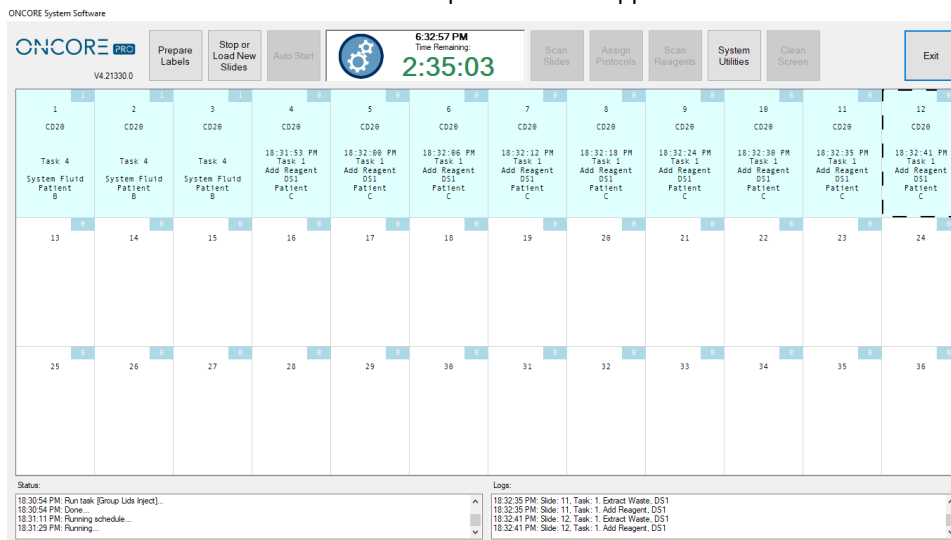

Figure 55

Continuous loading can be repeated on successive steps in the new run schedule; however, the overall runtime for the Stopped slides will increase with each load of slides.

### 4.13. Shutting Down the Slide Stainer

From the Main screen, double click “Exit” to close the program. Click “Yes” to confirm.

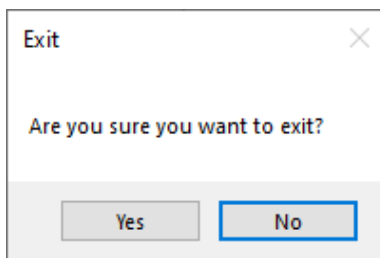

Figure 56

This process may take a few minutes as the system waits for all module lids to go the extract position and for all sub-applications to close. Wait for the application to close completely and return to the login screen before powering off the instrument

Push and hold the power button on the lower right side of the instrument to power down. Wait a few minutes after powering down to ensure the instrument powers down completely.

(Optional) Turn off the power supply switch on the back of the instrument.

Shut down the computer from the Start Menu.

**⚠ Do not set the module lids to the down position for any extended period of time.** Modules should rest in the extract position when idle.



*Before shutting down the Slide Stainer for an extended period of time (i.e.: long weekends, holidays, transport), prime the pumps and tubing lines with distilled water to prevent excess buildup of salt. Clean the modules with a moist paper towel to remove any residual buffer that may dry along the hinge slot and slip holder.*

## Section 5. System Utilities

From the Main screen, click “**System Utilities**” to access additional utility functions and advanced features. Some features may be restricted depending on user’s security access level. Refer to **Security**, p. 80, for more information.

### 5.1. Tools

Perform manual operations with the system using the functions found under the “**Tools**” tab.

*\*Note: Depending on the configuration of the system, some of these functions may not be available to all users.*

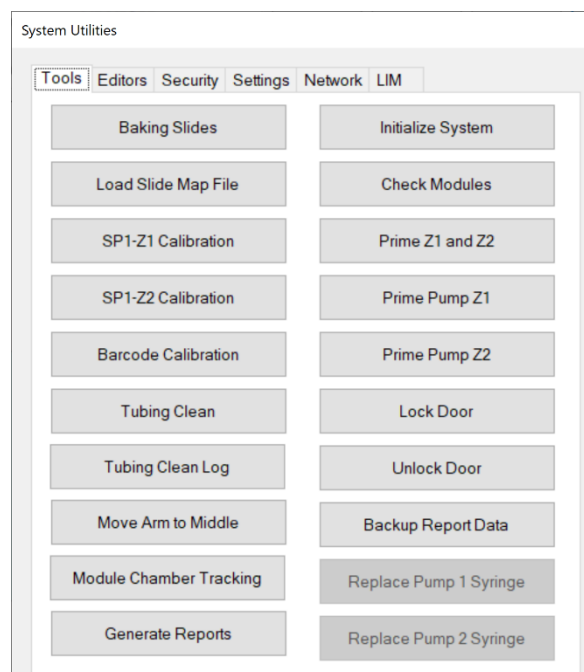

1. Baking Slides
2. Load Slide Map File
3. SP1-Z1 Calibration
4. SP1-Z2 Calibration
5. Barcode Calibration
6. Tubing Clean
7. \*(Option) Tubing Clean Log
8. Move Arm to Middle
9. \*(Option) Module Chamber Tracking
10. Generate Reports
11. Initialize System
12. Check Modules
13. Prime Pump Z1 and Z2
14. Prime Pump Z1
15. Prime Pump Z2
16. Lock Door
17. Unlock Door
18. Backup Report Data
19. Replace Pump 1 Syringe
20. Replace Pump 2 Syringe

Figure 57

#### Prepare Slides with Baking Slides Function

Click “**Baking Slides**” to select slides for baking. Check the boxes to select an entire row or select individual slides by module position. Refer to **Baking Slide Settings**, p. 81, for more information.

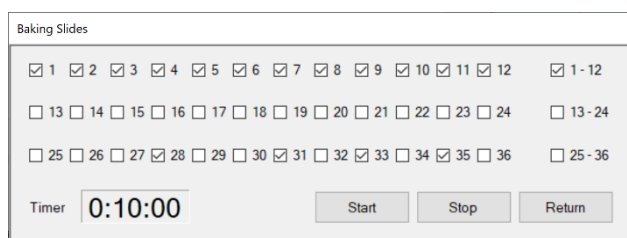

Figure 58

Click “**Start**” to begin baking. The timer on the left will begin counting down and automatically shut heaters off once the timer reaches **0:00:00**.

Click “**Stop**” to manually stop baking.

Refer to **Baking Slides Settings**, p. 81, to set up slides for automatic baking before every run.

### Load a Saved Slide Map File

Click “**Load Slide Map File**” to load and view a previously run slide map on the Main screen. The system automatically saves the slide map file for each set of slides run on the instrument.

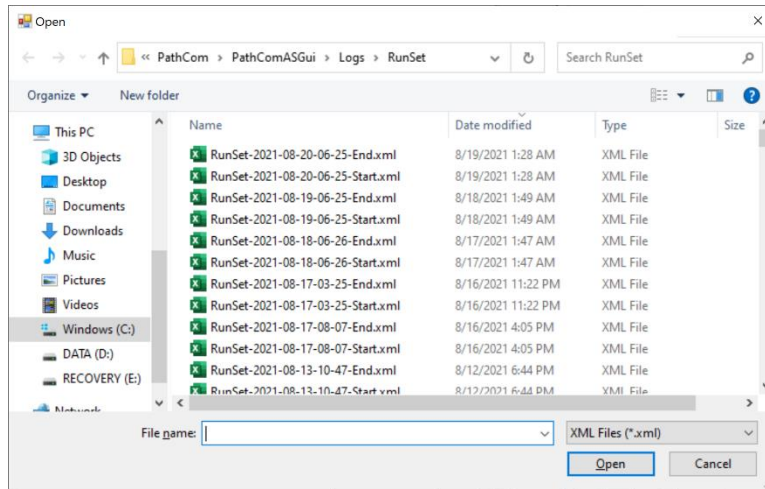

Figure 59

### Verify the Calibration of SP1-Z1 or SP1-Z2

Click “**SP1-Z1 Calibration**” to move the Z1 probe to module #1 and verify the XYZ position of the Z1 probe. Click “**SP1-Z2 Calibration**” to move the Z2 probe to module #1 and verify the XY-Z position of the Z2 probe.

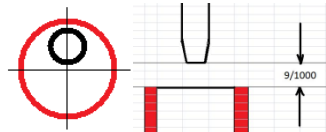

Figure 60

### Verify the Calibration of the Barcode Reader

Click “**Barcode Calibration**” to move the Barcode Reader to module #1 and verify the XY position of the barcode reader.

## Clean Z1/Z2 Tubing

Click “**Tubing Clean**” to open the tubing cleaning feature.

Use the Tubing Cleaning Kit or fill two **15mL** vials with an appropriate cleaning solution.

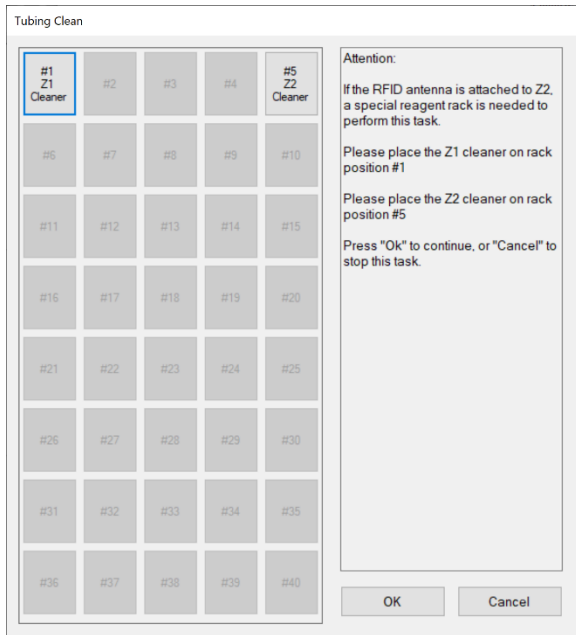

Figure 61

Place Z2 cleaning solution in reagent rack position #5.  
Recommendations: Use **Slide Brite** to remove wax residues in the Z2 tubing.

Place Z1 cleaning solution in reagent rack position #1.  
Recommendations: Use 1% **Bleach** to remove Hematoxylin/DAB precipitate in the Z1 tubing.

Close the door and click “**OK**” to initiate the tubing clean process.

The Z1 and Z2 probes will both aspirate **5mL** of cleaning solution into the tubing from their respective reagent rack positions. The system will then initiate a 20 minute countdown.

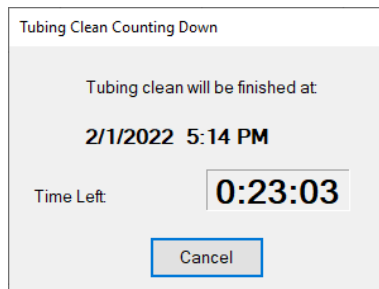

Figure 62

After 20 minutes has elapsed, the system will automatically perform a **System Initialization** and purge the cleaning solution waste.

Click “**Cancel**” at any moment to immediately purge the waste from the tubing.

### (Optional) Access the Tubing Clean Log

If **Tubing Clean Tracking** is enabled, the system tracks the number of slides processed since the last tubing clean. If the total number of slides run exceeds the set threshold, the system will block the user from initiating a new staining process. Refer to **Tubing Clean Tracking Option**, p. 85, for more information.

Click **“Tubing Clean Log”** to review the tubing cleaning status.

Perform a tubing clean to reset the counter or click **“Reset”** to manually set the counter to 0.

Tubing Clean Log

Tubing Clean Counters

Slides since last clean: 140

Total Runs: 10 **Reset**

Purge Tubing Cleaning Records

Dated Before: Tuesday, February 1, 2022 **Remove**

**Remove All**

**Show Tubing Clean Records** **Return**

Figure 63

Click **“Show Tubing Clean Records”** to review the entire log of tubing cleans performed to date.

Click **“Remove”** to clear all cleaning records before the set **Date Before**.

(Alternative option) Click **“Remove All”** to clear all tubing records-to-date.

Tubing Clean Log Records

1/24/2022 7:08:39 PM

Data Time	User Name	Slides Since Last Clean	Total Runs	Clean
11/19/2018 10:50:02 PM	Distributor	149	7	Yes
11/21/2018 10:12:33 PM	Distributor	144	4	No
11/28/2018 11:38:07 PM	Distributor	144	4	No

Figure 64

### (Optional) Reset the Module/Chamber Usage Counter

If **Module Chamber Tracking** is enabled, the system tracks the number of slides processed on each module.

If the total number of slides run exceeds the set threshold, the system will display a red warning message to notify the user that it is time to replace the chamber. Refer to **Module Tracking Option**, p. 86, for more information.

Reset Module And Chamber Counters

Select Modules:

1  2  3  4  5  6  7  8  9  10  11  12  1-12

13  14  15  16  17  18  19  20  21  22  23  24  13-24

25  26  27  28  29  30  31  32  33  34  35  36  25-36

**Reset**

Total Number Of Stained Slides

140 **Reset** **Return**

Figure 65

Click **“Reset”** to reset the counter for selected modules back to 0 after replacing the chambers.

## Generate Reports

Click “**Generate Reports**” to open the **Report Generator** utility.

Refer to **Section 6: Reports**, p. 90, for more information.

## Move Robot XYZ Arm to Middle

Close the door and click “**Move Arm to Middle**” to move the robotic arm to the center of the instrument.

This will enable the user to gain access to the left side of the instrument to fill the buffer bottle and inspect wash stations, pumps (if applicable) etc.

## Perform System Initialization

Close the door and click “**Initialize System**” to initiate system initialization. The robot will initialize the XYZ axes while all 36 module lids move up to Home. Then each pump will initialize over its respective waste station.

## Check for Module Malfunction

Click “**Check Modules**” to check the function of the modules.

The Check Modules window will open to display 36 module checkboxes.

Select the modules using the check boxes then select an option to perform the check:

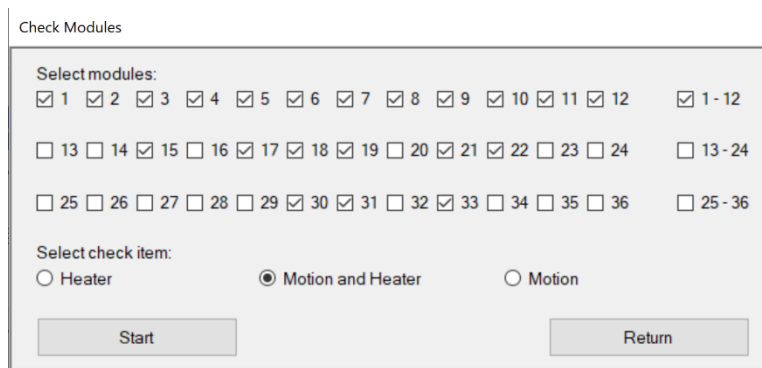

Check Modules

Select modules:

1  2  3  4  5  6  7  8  9  10  11  12  1 - 12

13  14  15  16  17  18  19  20  21  22  23  24  13 - 24

25  26  27  28  29  30  31  32  33  34  35  36  25 - 36

Select check item:

Heater  Motion and Heater  Motion

Figure 66

Click “**Start**” to initialize the system and start the countdown timer.

The modules will heat up to a high temperature >100C.

 **Take precaution not to touch the modules until the heater check has completed and the modules have cooled down.**

Click “**Cancel**” to cancel the module check at any time.

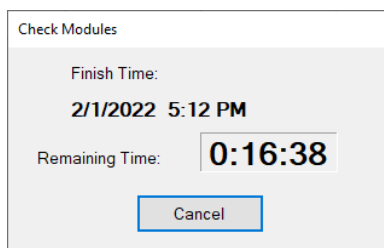

Check Modules

Finish Time:  
**2/1/2022 5:12 PM**

Remaining Time: **0:16:38**

Figure 67

- 1) Select the Heater option to check for heater malfunction only.  
The system will preheat the heaters to 40C, then heat to 103C and verify the temperatures.  
The system will highlight any malfunctioning heater in **red** on the slide map and mark “Low Temperature” or “Overheating”; otherwise, the system will return the message: **“All heaters are functioning properly.”**

 **The heaters will take several minutes to heat to higher temperatures during the heater check. To avoid burns/injury, do not resume operation until the heaters have cooled down sufficiently.**

- 2) Select the Motion option to check for module motion malfunction only.  
The system will move the lids to verify all module agitation heights: Home, Extract, Inject and A1-A7.  
The system will highlight any malfunctioning module in red on the slide map and mark “Module Malfunction”; otherwise, the system will return the message: **“All modules are functioning properly.”**
- 3) Select the Motion and Heater option to check for both module motion and heater malfunction.  
The system will perform both the heater check and the motion check on the selected modules.

1	2	3	4	5	6	7	8	9	10	11	12
13	14	15	16	17	18	19	20	21	22	23	24
25	26	27	28 Low Temperature	29	30	31	32	33	34	35	36

Figure 68

 **Protocols may not be assigned to a slide position with a malfunctioning heater or module until the module is replaced or repaired, and a new module check is performed to clear the error.**  
*Contact Customer Service to repair/replace any malfunctioning heaters or modules.*

### **Flush Tubing with Prime Pump Z1 and Z2 Function**

To flush out the tubing, connect a bottle of distilled water. To clear the tubing lines, connect an empty bottle. Click **"Prime Z1 and Z2"** to prime each pump 5x over the waste station.

### **Prime Pump Z1 or Pump Z2**

Pump 1 is connected to the Z1 tubing line. Click **"Prime Pump Z1"** to check the function of Pump 1. The Z1 probe will move to the wash station and dispense one full draw of buffer.

Pump 2 is connected to the Z2 tubing line. Click **"Prime Pump Z2"** to check the function of Pump 2. The Z2 probe will move to the wash station and dispense one full draw of buffer.

### **Lock or Unlock Door**

Click **"Lock Door"** to manually lock the door.

Click **"Unlock Door"** to manually unlock the door.

### **Backup Report Data**

Click **"Backup Report Data"** to make a backup copy of the report data.

*Refer to **Section 6: Reports**, p.90, for more information.*

### **Replace Pump 1 Syringe or Pump 2 Syringe (Distributor Access only)**

To prevent leaks/water damage, prime the pump several times using **"Prime Z1 and Z2"** to clear the fluid in the tubing line before removing the syringe. Dry the syringe and port valve opening before installing the new syringe.

Click **"Replace Pump 1 Syringe"** to move the plunger into position before removing the pump 1 syringe.

Click **"Replace Pump 2 Syringe"** to move the plunger into position before removing the pump 2 syringe.



## 5.2. Editors

Access the protocol, reagent, and RFID editors under the “Editors” tab.

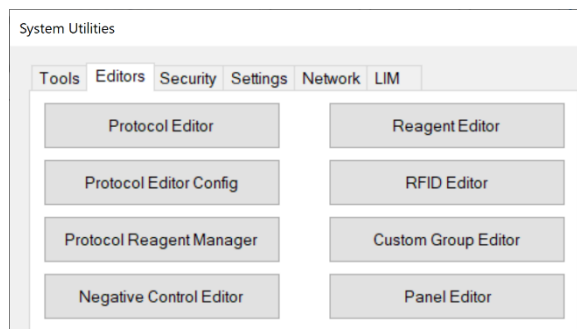

Figure 69

### Editing Protocols in the Protocol Editor: Overview

Click “Protocol Editor” to open the Protocol Editor window.

The system is pre-installed with a set of protocols optimized to run on the instrument; however, the **Protocol Editor** provides several modes of customization to fine-tune the protocols to accommodate the individual tissue and staining requirements of each lab:

- a. Adjust key protocol customizations
- b. Change protocol templates
- c. Add new protocols
- d. Create and modify special protocols (Distributor Access only)
- e. Create and modify protocol templates (Distributor Access only)

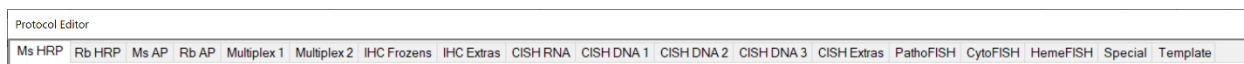

Figure 70

**Protocols** are grouped under separate tabs for each detection system type, i.e.: HRP, AP, ISH, FISH.

*Note: The available detection system types may vary based on the system configuration.*

Every protocol (except those listed under Special and Template) is assigned a protocol template.

**Protocol Templates** are grouped under the Templates tab.

The protocol template is used as the base to generate all protocol parameters, excluding the primary reagent and the saved protocol customizations.

**Special protocols** are grouped under the Special tab.

Special protocols are stand-alone protocols that are not generated from a protocol template.

Click **"Version"** to display the manufacturer's protocol version control number (if applicable). The version control number may be updated each time the manufacturer releases a new set of default protocols and reagents. *Note: User-added protocols do not affect the version control number.*

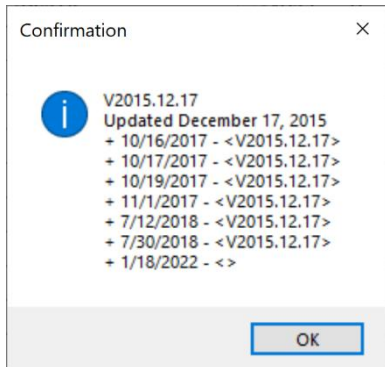

Figure 71

Click **"Protocol List"** in the main window to display the complete list of all protocols, including negative control protocols, special protocols, and templates. *Note: Click "Save" to export the list to an external text file.*

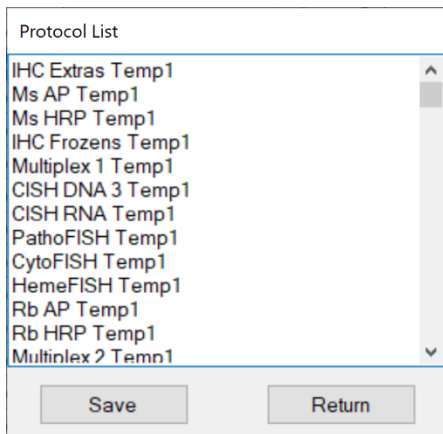

Figure 72

## Adjusting Protocol Customizations: IHC

Select the appropriate tab in the **Protocol Editor** to access all protocols grouped under that detection system type.

Protocol Editor																		
Ms HRP		Rb HRP	Ms AP	Rb AP	Multiplex 1	Multiplex 2	IHC Frozen	IHC Extras	CISH RNA	CISH DNA 1	CISH DNA 2	CISH DNA 3	CISH Extras	PathoFISH	CytoFISH	HemeFISH	Special	Template
Mark as Changed	Index	Protocol Name	Description	DS Buffer Option	AR Option	Temp. (°C)	Block Option	Reagent Name	Time Hour	Min.	Temp. (°C)							
<input type="checkbox"/>	43	Bcl-6	Ms HRP Template 1 V3/130ul 20181022 end 22..	DS2-50	AR1, high pH	101	Buffer	Bcl-6	0	30	25							
<input type="checkbox"/>	47	CD138	Ms HRP Template 1 V3/130ul 20181022 end 22..	DS Buffer	AR1, high pH	101	Buffer	CD138	0	30	25							
<input type="checkbox"/>	35	CD15	Ms HRP Template 1 V3/130ul 20181022 end 22..	DS2-50	AR1, high pH	103	Buffer	CD15	0	59	25							
<input type="checkbox"/>	37	CD20	Ms HRP Template 1 V3/130ul 20181022 end 22..	DS2-50	AR2, low pH	101	Buffer	CD20	0	30	25							
<input type="checkbox"/>	49	CD21	Ms HRP Template 1 V3/130ul 20181022 end 22..	DS2-50	AR2, low pH	90	Block	CD21	0	30	25							
<input type="checkbox"/>	39	CD23	Ms HRP Template 1 V3/130ul 20181022 end 22..	DS2-50	AR1, high pH	85	Block	CD23	0	30	25							
<input type="checkbox"/>	45	CD34	Ms HRP Template 1 V3/130ul 20181022 end 22..	DS2-50	AR1, high pH	101	Buffer	CD34	0	30	25							
<input type="checkbox"/>	51	CD56	Ms HRP Template 1 V3/130ul 20181022 end 22..	DS Buffer	AR1, high pH	101	Buffer	CD56	0	45	25							
<input type="checkbox"/>	53	CD7	Ms HRP Template 1 V3/130ul 20181022 end 22..	DS2-50	AR1, high pH	101	Block	CD7	0	30	25							
<input type="checkbox"/>	61	CDX2	Ms HRP Template 1 V3/130ul 20181022 end 22..	DS2-50	AR1, high pH	101	Buffer	CDX2	0	30	25							
<input type="checkbox"/>	55	CK19	Ms HRP Template 1 V3/130ul 20181022 end 22..	DS2-50	AR2, low pH	90	Block	CK19	0	30	25							
<input type="checkbox"/>	57	CK20	Ms HRP Template 1 V3/130ul 20181022 end 22..	DS2-50	AR2, low pH	101	Buffer	CK20	0	30	25							
<input type="checkbox"/>	59	CK7	Ms HRP Template 1 V3/130ul 20181022 end 22..	DS2-50	AR1, high pH	101	Buffer	CK7	0	30	25							
<input type="checkbox"/>	63	GATA-3	Ms HRP Template 1 V3/130ul 20181022 end 22..	DS2-50	AR2, low pH	101	Block	GATA-3	0	30	25							
<input type="checkbox"/>	65	Mammaglobin	Ms HRP Template 1 V3/130ul 20181022 end 22..	DS2-50	AR2, low pH	95	Buffer	Mammaglobin	0	30	25							
<input type="checkbox"/>	69	MSH2	Ms HRP Template 1 V3/130ul 20181022 end 22..	DS2-50	AR1, high pH	101	Buffer	MSH2	0	45	37							
<input type="checkbox"/>	73	MSH6	Ms HRP Template 1 V3/130ul 20181022 end 22..	DS2-50	AR1, high pH	101	Buffer	MSH6	0	45	37							
<input type="checkbox"/>	75	p63	Ms HRP Template 1 V3/130ul 20181022 end 22..	DS2-50	AR1, high pH	101	Buffer	p63	0	30	25							

Save
Edit
Add
Delete
Change Template
Refresh
Refresh All Protocols
Protocol List
Version
Cancel
Return

Figure 73

Select a protocol by clicking the empty cell in the left column of the editor. The selection will highlight in blue.

To display the full protocol, click “Edit” to open the **Advanced Protocol Editor**.

*Note: The user cannot edit the protocol directly from this window because the protocol is generated from a template.*

Advanced Protocol Editor																
Protocol Name	Protocol Type	Primary Reagent	Template	Control Reagent	Description	Open To										
CD20	Ms HRP	CD20	Ms HRP Temp1	CD20	Ms HRP Template 1 V3/130ul 20181022 end 220ulA4	Distributor										
Step Index	Set	Extract	Link	Max Group Size	Reagent Type	Reagent Name	Volume (µL)	Incubation Type	Incubation Time	Incubation Temperature Table	Agitation	Wash Buffer Type	Wash Buffer	#	Volume (µL)	EditMask
1	A	<input type="checkbox"/>	<input type="checkbox"/>	18	Dewax	DS1	240	Normal	00:05:00	00:00:00 - 00:04:30 65°C 00:04:30 - 00:06:00 62°C 00:06:00 - 00:30:00 58°C 00:30:00 - 00:59:00 55°C	Inject 00:00:01 A4 00:00:59 T < 71°C	Buffer	System Fluid	0	85	0
2	A	<input checked="" type="checkbox"/>	<input type="checkbox"/>	18	Others	DS Buffer	200	Normal	00:04:30	00:00:00 - 00:02:30 58°C 00:02:30 - 00:08:00 55°C 00:08:00 - 00:59:00 37°C	Inject 00:00:01 A4 00:00:59 T < 71°C	Buffer	Buffer	1	220	0
3	B	<input checked="" type="checkbox"/>	<input type="checkbox"/>	18	Retrieval	AR2, low pH	370	Normal	00:32:00	00:00:00 - 00:27:00 101°C 00:27:00 - 00:59:00 40°C	A3 00:15:00 A4 00:17:00 T < 110°C	Buffer	System Fluid	1	200	0
4	B	<input checked="" type="checkbox"/>	<input type="checkbox"/>	18	Buffer	System Fluid	220	Normal	00:04:20	00:00:00 - 00:59:00 33°C	Inject 00:00:01 A4 00:00:59 T < 71°C	Buffer	System Fluid	0	85	0
5	C	<input checked="" type="checkbox"/>	<input type="checkbox"/>	18	Antibody C-C	CD20	130	Normal	00:30:00	00:00:00 - 00:30:00 25°C	Inject 00:00:01 A7 00:01:30 T < 71°C	Buffer	System Fluid	1	240	0

Figure 74

Most parameters displayed in the Advanced Protocol Editor are determined by the protocol template; however, the user has the option to make further customization by changing the protocol template or creating a special protocol. Refer to **Creating and Modifying Protocol Templates**, p. 62, and **Creating and Modifying Special Protocols**, p. 61, for more information.

The user may adjust the key protocol parameters directly in the main window: pretreatment, antigen retrieval, peroxidase blocking and antibody incubation.

DS Buffer Option	AR Option	Temp. (°C)	Block Option	Reagent Name	Time		Temp. (°C)
					Hour	Min.	
DS2-50	AR1, high pH	101	Buffer	Bcl-6	0	30	25
DS Buffer	AR1, high pH	101	Buffer	CD138	0	30	25
DS2-50	AR1, high pH	103	Buffer	CD15	0	59	25
DS Buffer	AR2, low pH	101	Buffer	CD20	0	30	25
DS Buffer	AR2, low pH	90	Block	CD21	0	30	25
DS2-50	AR1, high pH	85	Block	CD23	0	30	25
DSE-50	AR1, high pH	85	Block	CD23	0	30	25

Figure 75

**To customize the pretreatment reagent**, select from the dropdown list under **DS Buffer Option**.

- DS2-50. This is the default option. Dewax solution 2 is applied to enhance antigen retrieval.
- DS Buffer. Select this option to apply wash buffer instead of Dewax solution 2. This option may improve morphology or improve over-staining by reducing the strength of antigen retrieval.
- DSE-50. Select this option to apply a protease enzyme, incubated at 58C, instead of Dewax Solution 2.

**To customize the antigen retrieval reagent**, select from the dropdown list under **AR Option**.

- AR1. This is the default option. Antigen Retrieval solution 1, high pH 9 is applied.
- AR2. Select this option to apply Antigen Retrieval solution 2, low pH 6. This may improve morphology or improve over-staining by reducing the strength of antigen retrieval.
- AR Buffer. Select this option to apply wash buffer instead of Antigen Retrieval solution. This option may be used when antigen retrieval is not required. Note: Set incubation temperature to 37C to reduce evaporation.
- AR Enzyme. Select this option to apply a custom enzyme instead of Antigen Retrieval solution.  
*Note: Set incubation temperature to 37°C. Requires 370uL/test fill volume.*  
*Note: It is recommended to create an alternate protocol template or special protocol because the high volume may cause some overflow.*

**To customize the antigen retrieval incubation temperature**, adjust the **Temp (°C)**.

- 101C is the default temperature for antigen retrieval.
- Reduce the temperature to 98C /95C (or lower) to reduce the strength of antigen retrieval.
- Increase the temperature to 103C or higher to increase the strength of antigen retrieval.
- Reduce the temperature to 37C if an enzyme or buffer option was selected.

**To customize the peroxidase blocking reagent**, select from the dropdown list under **Block Option**.

- Buffer. This is the default option (no blocking step). AR1 is formulated to provide sufficient blocking under most conditions.
- Block. Select this option to apply H<sub>2</sub>O<sub>2</sub> block instead of wash buffer.

**To customize the primary antibody incubation time and temperature**, adjust the **Time (hh,mm,ss)** and **Temp (°C)**.

- 25C is the default temperature for antibody incubation.
- Increase the incubation temperature to 37C to increase staining intensity.
- Decrease the incubation time (minimum 10min) to decrease the staining intensity.
- Increase the incubation time to 45min/1hr to increase staining intensity.  
*Note: Increasing the incubation time (or temperature) may affect the staining area by increasing evaporation. It is recommended to adjust the antibody dilution to maintain an incubation time ≤30min.*

Click **“Save”** to apply and save the changes to the selected protocol(s).  
 All protocols that have been modified from the manufacturer’s default protocol will be **“Marked as Changed”**.

 The user may backup these protocol customizations under System Utilities>Settings>**“Save All Customizations”**. Refer to p. 84, **Save All Customizations**, for more details.

Protocol Editor												
<span>Ms HRP</span> <span>Rb HRP</span> <span>Ms AP</span> <span>Rb AP</span> <span>Multiplex 1</span> <span>Multiplex 2</span> <span>IHC Frozen</span> <span>IHC Extras</span> <span>CISH RNA</span> <span>CISH DNA 1</span> <span>CISH DNA 2</span> <span>CISH DNA 3</span> <span>CISH Extras</span> <span>PathoFISH</span> <span>CytoFISH</span> <span>HemeFISH</span> <span>Special</span> <span>Template</span>												
Mark as Changed	Index	Protocol Name	Description	DS Buffer Option	AR Option	Temp. (°C)	Block Option	Reagent Name	Time Hour	Min.	Temp. (°C)	
<input type="checkbox"/>	43	Bcl-6	Ms HRP Template 1 V3/130ul 20181022 end 22...	DS2-50	AR1, high pH	101	Buffer	Bcl-6	0	30	25	
<input type="checkbox"/>	47	CD138	Ms HRP Template 1 V3/130ul 20181022 end 22...	DS Buffer	AR1, high pH	101	Buffer	CD138	0	30	25	
<input type="checkbox"/>	35	CD15	Ms HRP Template 1 V3/130ul 20181022 end 22...	DS2-50	AR1, high pH	103	Buffer	CD15	0	59	25	
<input checked="" type="checkbox"/>	37	CD20	Ms HRP Template 1 V3/130ul 20181022 end 22...	DS Buffer	AR2, low pH	101	Buffer	CD20	0	30	25	
<input type="checkbox"/>	49	CD21	Ms HRP Template 1 V3/130ul 20181022 end 22...	DS2-50	AR2, low pH	90	Block	CD21	0	30	25	
<input type="checkbox"/>	39	CD23	Ms HRP Template 1 V3/130ul 20181022 end 22...	DS2-50	AR1, high pH	85	Block	CD23	0	30	25	
<input type="checkbox"/>	45	CD34	Ms HRP Template 1 V3/130ul 20181022 end 22...	DS2-50	AR1, high pH	101	Buffer	CD34	0	30	25	
<input type="checkbox"/>	51	CD56	Ms HRP Template 1 V3/130ul 20181022 end 22...	DS Buffer	AR1, high pH	101	Buffer	CD56	0	45	25	
<input type="checkbox"/>	53	CD7	Ms HRP Template 1 V3/130ul 20181022 end 22...	DS2-50	AR1, high pH	101	Block	CD7	0	30	25	
<input type="checkbox"/>	61	CDX2	Ms HRP Template 1 V3/130ul 20181022 end 22...	DS2-50	AR1, high pH	101	Buffer	CDX2	0	30	25	
<input type="checkbox"/>	55	CK19	Ms HRP Template 1 V3/130ul 20181022 end 22...	DS2-50	AR2, low pH	90	Block	CK19	0	30	25	
<input type="checkbox"/>	57	CK20	Ms HRP Template 1 V3/130ul 20181022 end 22...	DS2-50	AR2, low pH	101	Buffer	CK20	0	30	25	
<input type="checkbox"/>	59	CK7	Ms HRP Template 1 V3/130ul 20181022 end 22...	DS2-50	AR1, high pH	101	Buffer	CK7	0	30	25	
<input type="checkbox"/>	63	GATA-3	Ms HRP Template 1 V3/130ul 20181022 end 22...	DS2-50	AR2, low pH	101	Block	GATA-3	0	30	25	
<input type="checkbox"/>	65	Mamaglobin	Ms HRP Template 1 V3/130ul 20181022 end 22...	DS2-50	AR2, low pH	95	Buffer	Mamaglobin	0	30	25	
<input type="checkbox"/>	69	MSH2	Ms HRP Template 1 V3/130ul 20181022 end 22...	DS2-50	AR1, high pH	101	Buffer	MSH2	0	45	37	
<input type="checkbox"/>	73	MSH6	Ms HRP Template 1 V3/130ul 20181022 end 22...	DS2-50	AR1, high pH	101	Buffer	MSH6	0	45	37	
<input type="checkbox"/>	75	p63	Ms HRP Template 1 V3/130ul 20181022 end 22...	DS2-50	AR1, high pH	101	Buffer	p63	0	30	25	

Buttons: Save, Edit, Add, Delete, Change Template, Refresh, Refresh All Protocols, Protocol List, Version, Cancel, Return

Figure 76

Click **“Cancel”** to cancel all unsaved changes.  
 Click **“Return”** to exit the **Protocol Editor**.

### Adjusting Protocol Customizations: ISH/CISH/FISH

Select the appropriate protocol tab in the **Protocol Editor** to access ISH, CISH, or FISH protocols.

Protocol Editor												
<span>Ms HRP</span> <span>Rb HRP</span> <span>Ms AP</span> <span>Rb AP</span> <span>Multiplex 1</span> <span>Multiplex 2</span> <span>IHC Frozen</span> <span>IHC Extras</span> <span>CISH RNA</span> <span>CISH DNA 1</span> <span>CISH DNA 2</span> <span>CISH DNA 3</span> <span>CISH Extras</span> <span>PathoFISH</span> <span>CytoFISH</span> <span>HemeFISH</span> <span>Special</span> <span>Template</span>												
Mark as Changed	Index	Protocol Name	Description	Reagent Name	Time Hour	Min.	Temp. (°C)					
<input type="checkbox"/>	101	EBER Probe	CISH RNA Template 1 V3/130ul 20181022 end ...	ISHzyme	0	10	25					
<input type="checkbox"/>	103	Kappa Probe	CISH RNA Template 1 V3/130ul 20181022 end ...	ISHzyme	0	10	25					
<input type="checkbox"/>	105	Lambda Probe	CISH RNA Template 1 V3/130ul 20181022 end ...	ISHzyme	0	10	25					
<input type="checkbox"/>	107	RNA- Probe	CISH RNA Template 1 V3/130ul 20181022 end ...	ISHzyme	0	10	25					
<input type="checkbox"/>	109	RNA+ Probe	CISH RNA Template 1 V3/130ul 20181022 end ...	ISHzyme	0	10	25					

Buttons: Save, Edit, Add, Delete, Change Template, Refresh, Refresh All Protocols, Protocol List, Version, Cancel, Return



Figure 77

**To customize the enzyme incubation time and temperature**, adjust the **Time** (hh,mm,ss) and **Temp** (°C).  
 Click **“Save”** to apply and save the changes to the selected protocol(s).

 The user may backup these protocol customizations under System Utilities>Settings>**“Save All Customizations”**. Refer to p. 84, **Save All Customizations**, for more details.

## Refreshing Protocol Customizations

The user may save and restore the protocol customizations after making a change in the **Protocol Editor**.

  **Backup the protocol customizations before refreshing the protocols, if necessary.** Any recent customizations that have not been backed up using **“Save all Customizations”** will be overwritten during the refresh process. *Refer to **Save All Customizations**, p. 84, for more details.*

Click **“Protocol Editor”** to open the **Protocol Editor** window.

Select the protocol (s) by clicking the empty cell in the **left column** of the editor. The selection will highlight in blue.

Click **“Refresh”** and select the desired refresh option, then click **“OK”**.

A. **“Refresh with saved customization”** will restore the protocol(s) using the user’s saved customizations.

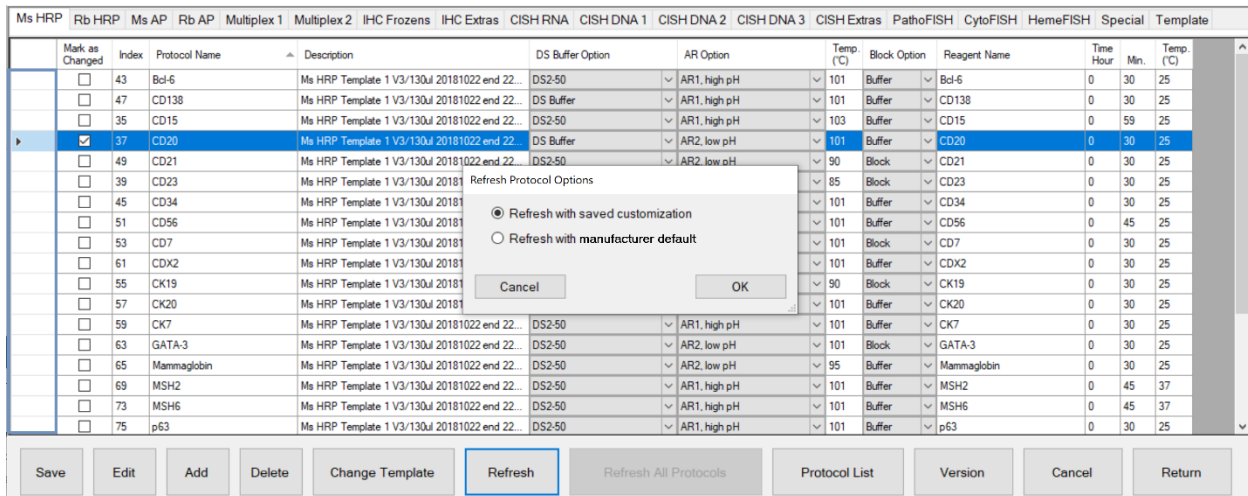

The screenshot shows the Protocol Editor window with a list of protocols. A dialog box titled "Refresh Protocol Options" is open, showing two radio button options: "Refresh with saved customization" (which is selected) and "Refresh with manufacturer default". The dialog box also has "Cancel" and "OK" buttons. The background table shows columns for Index, Protocol Name, Description, DS Buffer Option, AR Option, Temp. (°C), Block Option, Reagent Name, and Time (Hour, Min, Temp. (°C)).

Figure 78

B. **“Refresh with manufacturer default”** will reset the protocol(s) to the manufacturer’s customizations.

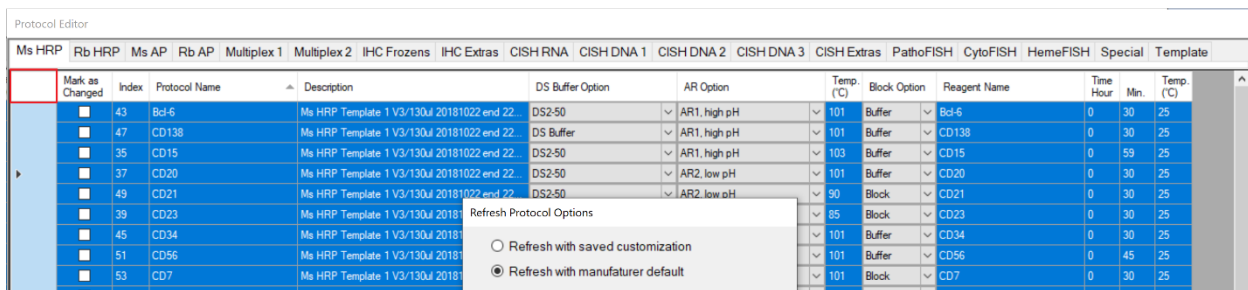

The screenshot shows the Protocol Editor window with a list of protocols. A dialog box titled "Refresh Protocol Options" is open, showing two radio button options: "Refresh with saved customization" and "Refresh with manufacturer default" (which is selected). The dialog box also has "Cancel" and "OK" buttons. The background table shows columns for Index, Protocol Name, Description, DS Buffer Option, AR Option, Temp. (°C), Block Option, Reagent Name, and Time (Hour, Min, Temp. (°C)).

Figure 79

*Tip: Select multiple protocols by holding down the **Ctrl** key. Select all protocols in the tab by clicking the cell in the **upper-left corner**.*



## Changing the Assigned Protocol Template

Some staining protocols may require further customization beyond the available parameters accessible in the main **Protocol Editor** window. In such circumstances, the user may assign a different protocol template.

**!** **Contact Technical Support for assistance. Only users with Distributor access may create or modify protocol templates. Refer to *Creating and Modifying Protocol Templates*, p. 61, for more information.**

Click **“Protocol Editor”** to open the **Protocol Editor** window.

Select the protocol by clicking the empty cell in the left column of the editor. The selection will highlight in blue.

To select a different protocol template, click **“Change Template”**.

The Select Template window will open and display the Protocol Templates available for this Protocol Type.

The current assigned protocol template is highlighted in blue.

**!** **Note: Make sure to save all current protocol customizations in Settings before proceeding. The protocols must be regenerated after changing the protocol template. Any unsaved customizations will be overwritten.**

The screenshot shows the Protocol Editor interface with a 'Select Template' dialog box open. The dialog has two sections: 'Protocol Templates' and 'Selected Template'. Under 'Protocol Templates', 'Ms HRP Temp1' and 'Ms HRP Temp2' are listed. Under 'Selected Template', 'Ms HRP Temp2' is selected. The background table shows a list of protocols with columns for Mark as Changed, Index, Protocol Name, Description, DS Buffer Option, AR Option, Temp. (C), Block Option, Reagent Name, Time Hour, Min., and Temp. (C). The row for index 37 (CD20) is highlighted in blue. The 'Change Template' button in the bottom toolbar is also highlighted.

Figure 80

Select the desired protocol template and click **“OK”** to change the template assignment. The system will automatically regenerate the protocol using the selected template and apply the saved protocol customizations.

The screenshot shows the Protocol Editor interface after the template change. The 'Select Template' dialog is closed. The background table now shows the updated protocol list. The row for index 37 (CD20) is highlighted in blue and shows 'Ms HRP Template 2 V3/130ul 20181022 end 220ulA4' as the assigned template. The 'Change Template' button in the bottom toolbar is no longer highlighted.

Figure 81

## Adding New Protocols in the Protocol Editor

The user may create new protocols to test third-party antibody products, different antibody titers, and various customization options to aid in staining optimization.

To add a new protocol, select the appropriate protocol tab of the **Protocol Editor**, and click **“Add”**.  
Input a unique name in the field for Protocol Name.

 Each protocol must have a unique name. Append a short suffix to the end of the protocol name to distinguish the detection system used or modifications made.

 To avoid conflicts with positive or negative controls in the programming software, please refrain from using the symbols **“+”** and **“-”** at the end of the protocol name.

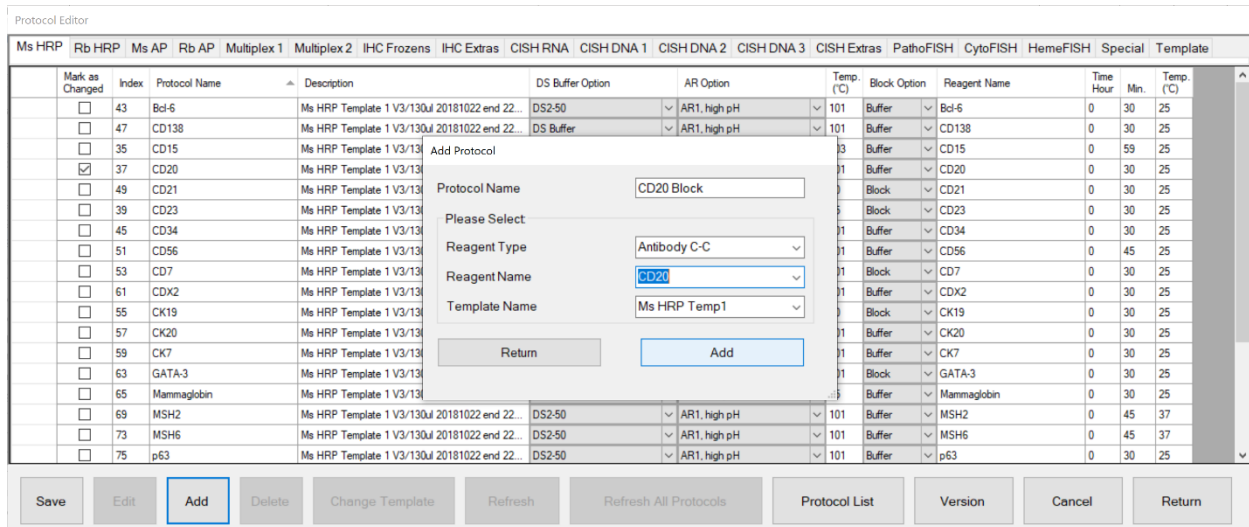

Figure 82

Select the **Reagent Type** and **Reagent Name** of the primary reagent.

Refer to *Adding New Reagents in the Reagent Editor*, p. 72, for more information on adding new reagents.

Select the **Template Name**, if more than one template is available.

Refer to *Creating and Modifying Protocol Templates*, p. 61, for more information on adding new templates.

Click **“Add”** to generate a new protocol from the selected protocol template.

Note: New protocol(s) will be generated with default customizations based on the protocol template.

The user must customize the new protocol(s) based on the desired test parameters, vendor’s datasheet, or manufacturer’s recommendations.

Click **“Return”** to close the window after all protocols are added.

To delete a protocol, select the protocol from the left-most column and click **“Delete”**.

*Note: The system may restrict the user from deleting certain protocols created by the manufacturer.*



## Creating and Modifying Special Protocols (Distributor Access only)

Special protocols are grouped under the Special tab of the **Protocol Editor**. These stand-alone protocols offer users the flexibility to customize each step of the staining protocol to fulfill the special requirements of new staining applications, i.e.: Special Stains, IF, Multiplex etc.

 **Only users with Distributor access may create special protocols. Contact Technical Support for assistance.** New protocols may be imported to the system using the Protocols and Reagents Manager. Refer to p. 69, *Importing Protocols in the PR Manager*.

Select the Special tab in the **Protocol Editor** to view the list of special protocols.

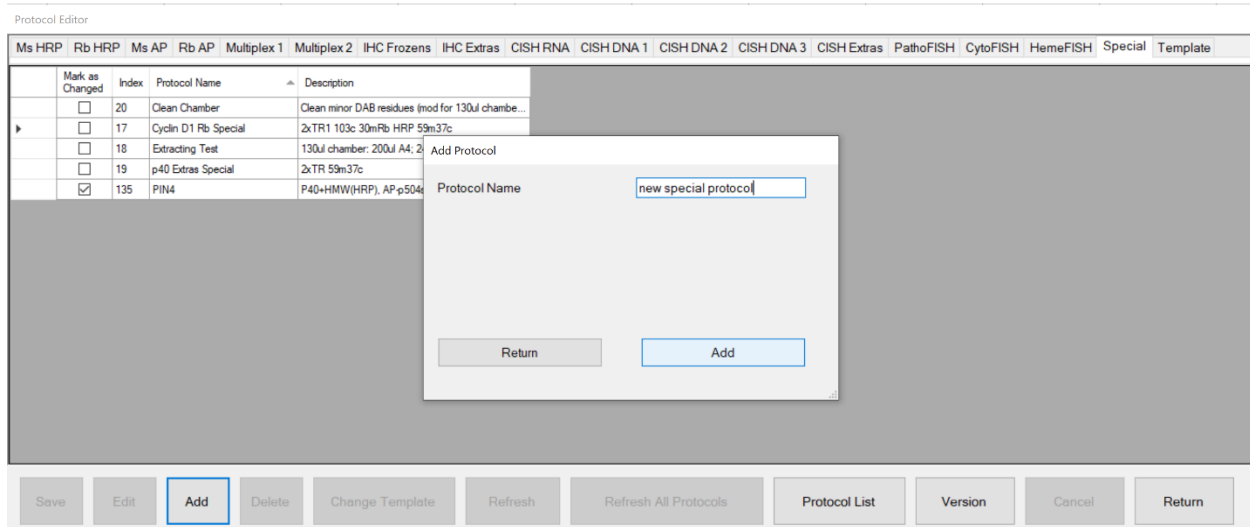



Figure 83

To add a new special protocol, click “Add”.

Enter the **Protocol Name** and click “Add” to generate a basic one-step protocol.

 **The protocol name must be unique.** Refer to the Protocol List to view the full list of protocols.

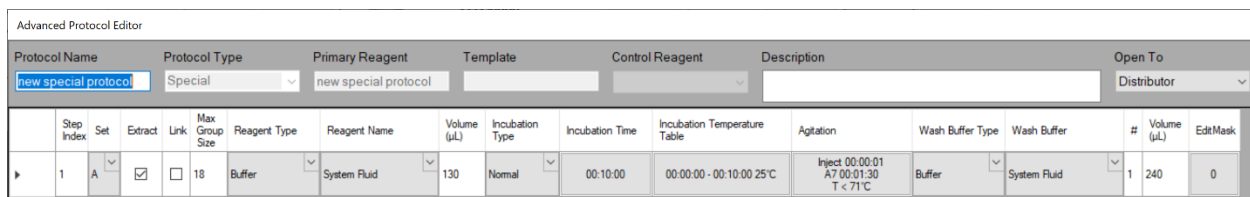

Figure 84

The **Advanced Protocol Editor** will automatically open to display the details of the special protocol.

Insert additional steps and modify the special protocol as needed.

Refer to *Editing Protocol Parameters in the Advanced Protocol Editor*, p. 65, for more information.

**Protocol Name** stores the name of the protocol.

**Protocol Type** identifies the protocol as Special.

**Primary Reagent** is not identified because special protocols are not generated from a template.

**Control Reagent** is not identified because special protocols are not customizable from the main window.

**Description** stores the description that will be displayed in the main window.

**Open To** stores the security access level of the protocol.

Alternatively, right-click and **Copy** a protocol, template or special protocol from any tab in the **Protocol Editor**.  
*Note: It is recommended to select a similar existing protocol to use as a base for generating the special protocol.*

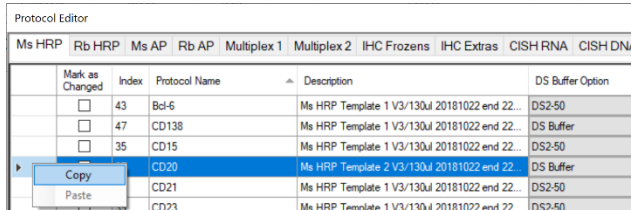

Figure 85

Right-click and **Paste** the protocol into the Special tab and enter the **Paste Name**.

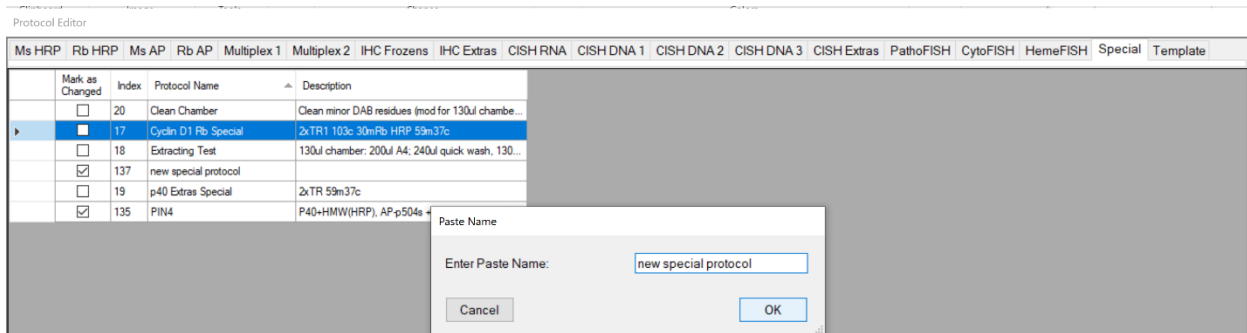

Figure 86

**To modify a special protocol**, select the protocol in the Special tab and click **“Edit”** to display the details of the protocol. *Note: Users with Distributor access may edit the special protocol directly from this window. Users with Supervisor access may have limited permissions to edit certain steps only.*

**To delete a special protocol**, select the protocol and click **“Delete”**. It is recommended to delete special protocols that are no longer used for system efficiency.

*Note: Manufacturer’s protocols may be protected by the system and cannot be removed.*

## Creating and Modifying Protocol Templates (Distributor Access only)

Protocol templates are grouped under the Templates tab of the **Protocol Editor**. Users may create additional templates to apply additional protocol customization(s) to a subset of protocols grouped under the same detection type. i.e.: add protein block step, add enzyme digestion step, customize counterstaining or customize antigen retrieval time.

**!** Only users with Distributor access may create or modify protocol templates protocols. Contact **Technical Support** for assistance. New templates may be imported to the system using the Protocols and Reagents Manager. Refer to p. 69, *Importing Protocols in the PR Manager*.

Select the Template tab in the **Protocol Editor** to view the list of protocol templates.

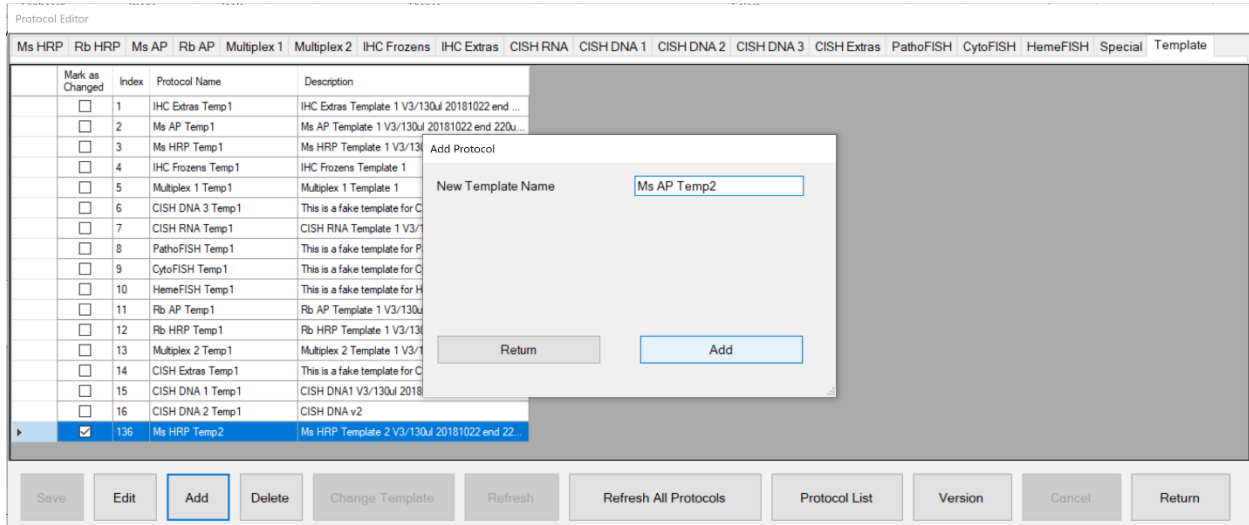

Figure 87

To add a new protocol template, click “Add”.

Enter the **Template Name** and click “Add” to generate a basic one-step protocol template with the **Primary Reagent** automatically added.

**!** The protocol template name must be unique and must contain the word, “Temp”  
 Note: “Temp” is preceded by a space.

**!** The template’s primary reagent must be set be the same as the protocol template name.  
 Note: This name is used as a space holder to indicate the position in the template to be replaced by each protocol’s primary reagent when the template is used to generate protocols.

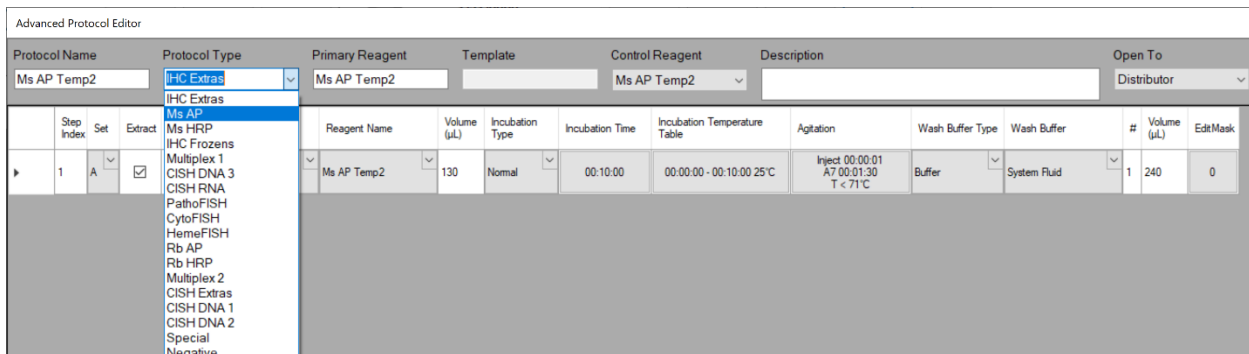

Figure 88

The **Advanced Protocol Editor** will automatically open to display the protocol template. Select the appropriate **Protocol Type**, or enter a new type. Insert additional steps and modify the protocol template as needed. Refer to *Editing Protocol Parameters in the Advanced Protocol Editor*, p. 65, for more information.

- Protocol Name** stores the name of the template.
- Protocol Type** identifies the detection system type assigned to the template.
- Primary Reagent** identifies the primary reagent (antibody or probe) in the template.
- Control Reagent** identifies the reagent to be customized for incubation time and temperature in the main window.
- Description** stores the description that will be displayed in the main window.
- Open To** stores the security access level of the template.

Alternatively, right-click and **Copy** a protocol, template or special protocol from any tab in the **Protocol Editor**. Note: It is recommended to select a similar existing protocol to use as a base for generating the template.

Right-click and **Paste** the protocol into the Template tab and enter the **Paste Name**.

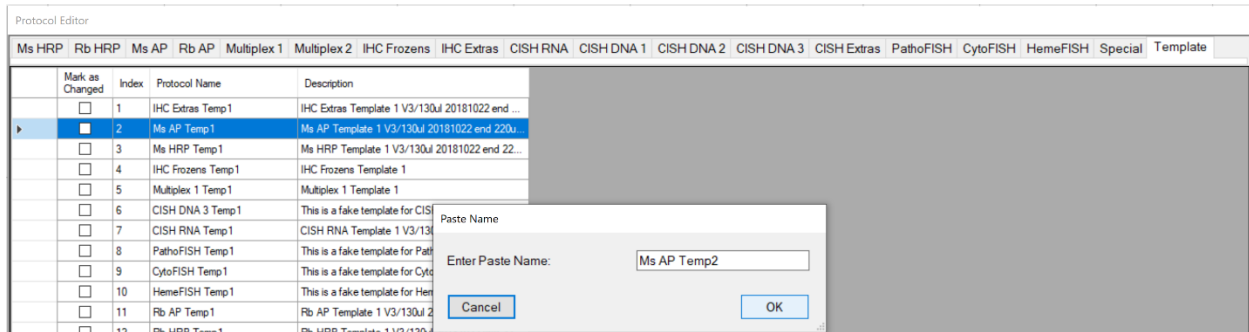

To **modify a template**, select the template in the Template tab and click **Edit** to display the details of the protocol template. Note: Users with Distributor access may edit the protocol template directly from this window.

**⚠** After saving changes to the protocol template, the system will automatically regenerate all assigned protocols to apply the changes. Note: The user may manually refresh all protocols with their assigned protocol templates by clicking **Refresh All Protocols** in the Templates tab.

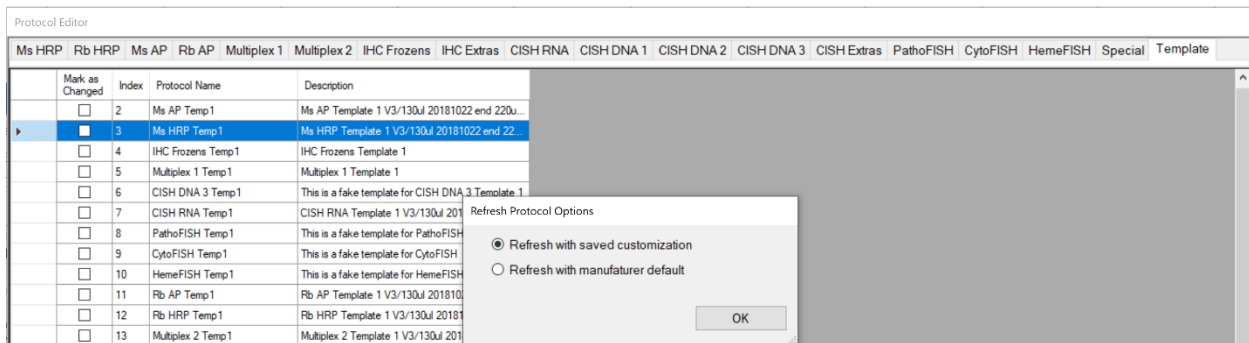

Figure 89

To **delete a template**, select the protocol and click **Delete**. All protocols assigned to the template must be deleted or assigned to a new template before the template may be deleted. Note: Manufacturer's templates may be protected by the system and cannot be removed.

## Editing Protocol Parameters in the Advanced Protocol Editor

Special Protocols and Templates may be modified using the **Advanced Protocol Editor**.

Advanced Protocol Editor

Protocol Name: PIN4    Protocol Type: Special    Primary Reagent: Unknown    Template:    Control Reagent:    Description: P40+HMW(HRP), AP-p504s +block 2018-09-10    Open To: Distributor

Step Index	Set	Extract	Link	Max Group Size	Reagent Type	Reagent Name	Volume (µL)	Incubation Type	Incubation Time	Incubation Temperature Table	Agitation	Wash Buffer Type	Wash Buffer	#	Volume (µL)	EdtMask
1	A	<input type="checkbox"/>	<input type="checkbox"/>	18	Dewax	DS1	240	Normal	00:05:00	00:00:00 - 00:04:30 65°C 00:04:30 - 00:59:30 58°C	Inject 00:00:01 A4 00:00:59 T < 71°C	Buffer	System Fluid	0	85	0
2	A	<input type="checkbox"/>	<input type="checkbox"/>	18	Dewax	DS2-50	200	Normal	00:04:45	00:00:00 - 00:02:30 58°C 00:02:30 - 00:59:30 40°C	Inject 00:00:01 A4 00:00:59 T < 71°C	Buffer	Buffer	1	220	0
3	A	<input type="checkbox"/>	<input type="checkbox"/>	18	Retrieval	TR1, high pH	370	Normal	00:27:00	00:00:00 - 00:21:00 101°C 00:21:00 - 00:59:00 40°C	A3 00:13:00 A4 00:14:00 T < 110°C	Buffer	System Fluid	1	200	0
4	A	<input type="checkbox"/>	<input type="checkbox"/>	18	Buffer	Block	220	Normal	00:04:30	00:00:00 - 00:59:00 33°C	Inject 00:00:01 A4 00:00:59 T < 71°C	Buffer	System Fluid	1	240	0
5	A	<input type="checkbox"/>	<input type="checkbox"/>	18	Special	P40+HMW	130	Normal	00:30:00	00:00:00 - 00:30:00 37°C	Inject 00:00:01 A7 00:01:30 T < 71°C	Buffer	System Fluid	1	240	0
6	D	<input checked="" type="checkbox"/>	<input type="checkbox"/>	18	Detect	HRP-A	130	Normal	00:09:00	00:00:00 - 00:59:00 25°C	Inject 00:00:01 A7 00:01:30 T < 71°C	Buffer	System Fluid	1	240	0
7	D	<input checked="" type="checkbox"/>	<input type="checkbox"/>	18	Detect	HRP-B	130	Normal	00:09:00	00:00:00 - 00:59:00 25°C	Inject 00:00:01 A7 00:01:30 T < 71°C	Buffer	System Fluid	1	240	0
8	D	<input checked="" type="checkbox"/>	<input type="checkbox"/>	18	Detect	HRP-C	130	Normal	00:09:00	00:00:00 - 00:09:00 25°C 00:09:00 - 00:11:00 37°C 00:11:00 - 00:59:00 32°C	Inject 00:00:01 A7 00:01:30 T < 71°C	Buffer	System Fluid	1	240	0
9	D	<input checked="" type="checkbox"/>	<input type="checkbox"/>	18	Buffer	System Fluid	240	Normal	00:04:30	00:00:00 - 00:59:00 35°C	Inject 00:00:01 A4 00:01:59 T < 71°C	Buffer	System Fluid	0	85	0
10	D	<input checked="" type="checkbox"/>	<input type="checkbox"/>	18	Buffer	System Fluid	240	Normal	00:04:30	00:00:00 - 00:06:00 32°C	Inject 00:00:01 A4 00:01:59 T < 71°C	Buffer	System Fluid	0	85	0
11	D	<input checked="" type="checkbox"/>	<input type="checkbox"/>	18	Detect	DAB on Board 1:1	220	Normal	00:09:00	00:00:00 - 00:59:00 25°C	Inject 00:00:01 A4 00:01:30 T < 71°C	Buffer	System Fluid	3	240	0

Buttons: Save, Copy, Cut, Paste Above, Paste Below, Insert Above, Insert Below, Delete, Undo, Return

Figure 90

Right-click the protocol step(s) or use the tool buttons to add and remove steps:  
 Select and **"Copy"** protocol step(s), then **"Paste..."** at another line in the protocol.  
 Select and **"Cut"** protocol step(s), then **"Paste..."** at another line in the protocol.  
 Select and **Insert...** a new step at any line in the protocol.  
 Select and **Delete** a step at any line in the protocol.

Click **"Save"** to save all changes.  
 Click **"Undo"** to revert to the previous saved state.  
 Click **"Return"** to close the **Advanced Protocol Editor**.

Edit the following parameters, as needed, for each step of the protocol or template.  
 Refer to the Specialist manual for more details.

Advanced Protocol Editor															
Protocol Name		Protocol Type		Primary Reagent		Template		Control Reagent		Description			Open To		
Ms HRP Temp1		Ms HRP		Ms HRP Temp1				Ms HRP Temp1		Ms HRP Template 1 V3/130ul 20181022 end 220ulA4			Distributor		
Step Index	Set	Extract	Link	Max Group Size	Reagent Type	Reagent Name	Volume (µL)	Incubation Type	Incubation Time	Incubation Temperature Table	Agitation	Wash Buffer Type	Wash Buffer	#	Volume (µL)
1	A	<input type="checkbox"/>	<input type="checkbox"/>	18	Dewax	DS1	240	Normal	00:05:00	00:00:00 - 00:04:30 65°C 00:04:30 - 00:06:00 62°C 00:06:00 - 00:30:00 58°C 00:30:00 - 00:59:00 55°C	Inject 00:00:01 A4 00:00:59 T < 71°C	Buffer	System Fluid	0	85
2	A	<input checked="" type="checkbox"/>	<input type="checkbox"/>	18	Dewax	DS2-50	200	Normal	00:04:30	00:00:00 - 00:02:30 58°C 00:02:30 - 00:08:00 55°C 00:08:00 - 00:59:00 37°C	Inject 00:00:01 A4 00:00:59 T < 71°C	Buffer	Buffer	1	220
3	B	<input checked="" type="checkbox"/>	<input type="checkbox"/>	18	Retrieval	AR1, high pH	370	Normal	00:32:00	00:00:00 - 00:27:00 101°C 00:27:00 - 00:59:00 40°C	A3 00:15:00 A4 00:17:00 T < 110°C	Buffer	System Fluid	1	200
4	B	<input checked="" type="checkbox"/>	<input type="checkbox"/>	18	Buffer	System Fluid	220	Normal	00:04:20	00:00:00 - 00:59:00 33°C	Inject 00:00:01 A4 00:00:59 T < 71°C	Buffer	System Fluid	0	85
5	C	<input checked="" type="checkbox"/>	<input type="checkbox"/>	18	Template	Ms HRP Temp1	130	Normal	00:30:00	00:00:00 - 00:30:00 25°C	Inject 00:00:01 A7 00:01:30 T < 71°C	Buffer	System Fluid	1	240
6	D	<input checked="" type="checkbox"/>	<input type="checkbox"/>	18	Buffer	System Fluid	220	Normal	00:00:10	00:00:00 - 00:59:00 25°C	Inject 00:00:01 A4 00:00:01 T < 71°C	Buffer	System Fluid	0	200
7	D	<input checked="" type="checkbox"/>	<input type="checkbox"/>	18	Detection	Mouse HRP	130	Normal	00:20:00	00:00:00 - 00:59:00 25°C	Inject 00:00:01 A7 00:01:30 T < 71°C	Buffer	System Fluid	1	240
8	D	<input checked="" type="checkbox"/>	<input type="checkbox"/>	18	Buffer	System Fluid	240	Normal	00:04:20	00:00:00 - 00:04:00 35°C	Inject 00:00:01 A4 00:01:59 T < 71°C	Buffer	System Fluid	0	85
9	D	<input checked="" type="checkbox"/>	<input type="checkbox"/>	18	Buffer	System Fluid	240	Normal	00:04:20	00:00:00 - 00:04:00 35°C	Inject 00:00:01 A4 00:01:59 T < 71°C	Buffer	System Fluid	1	240
10	D	<input checked="" type="checkbox"/>	<input type="checkbox"/>	18	Detection	DAB	200	Normal	00:08:40	00:00:00 - 00:08:00 37°C	Inject 00:00:01 A4 00:01:30 T < 71°C	Buffer	System Fluid	1	240
11	D	<input checked="" type="checkbox"/>	<input type="checkbox"/>	18	Buffer	System Fluid	240	Normal	00:00:10	00:00:00 - 00:00:00 25°C	Inject 00:00:01 A4 00:00:01 T < 71°C	Buffer	System Fluid	0	85

Figure 91

**Set.** Configure the RunSet pattern to optimize runtime scheduling. *Note: It is recommended to set the same standard RunSet pattern i.e.: AABBC(D variable) across all protocols and protocol templates to ensure that they can be run together efficiently in the same staining run.*

**Extract.** Select the option to extract the waste from the previous step before dispensing reagent.

**Link.** Select the option to link two consecutive steps. This will ensure that the current step is immediately executed upon completion of the previous step, without interruption from other processes running in the same staining run. *Note: Selecting this option may negatively affect overall runtime as it reduces scheduling flexibility.*

**Max Group Size.** Set the maximum group size smaller (default 18) to improve the incubation accuracy of time-sensitive reagents. The run scheduler will pool common steps between protocols and execute them together. Groups of 18 slides will have ~4 min longer “effective” incubation time compared to 1 slide, due to the longer dispensation time for a larger group. *Note: Setting a smaller group size will negatively affect overall runtime by increasing scheduling complexity.*

**Reagent Type and Reagent Name.** Select the reagent.

**Volume.** Set the reagent volume. The volume drawn from the vial is augmented by a factor of 1.08. The volume dispensed may vary slightly based on the viscosity level setting.

**Incubation Type:**

- A. Select **Normal** incubation. The “effective” incubation time is slightly longer than the set time due to the reagent dispensation time, which varies based on group size.
- B. Select **Fine** incubation to precisely control the incubation time <1min. The protocol step will be executed individually for each slide to ensure incubation accuracy (within seconds). System fluid is dispensed at the end of this process. *Note: This option may greatly affect overall runtime when the incubation time is set >2min.*
- C. Select **AirDry** incubation to perform a Fine incubation with drying. No fluid is dispensed at the end of this process.
- D. Select **Accurate** incubation to precisely control incubation time >1min.-This feature is currently in development and is not available at this time.

**Incubation Time.** Set the total incubation time.

*Note: Setting long incubations times may reduce the staining area, especially for heated processes.*

**Incubation Temperature Table.** Configure the temperature and corresponding heating time period.

*Note: Set the heat incubation longer than the Incubation Time to perform heated washes and to maintain the temperature until the next Step is executed.*

From	To	Temperature
1. 00:00:00 -	00:04:30	65
2. 00:04:30 -	00:59:30	58
3. 00:59:30 -	00:00:00	0

Figure 92

**Agitation.** Configure the agitation parameters. The module lids will alternate between two angles, **Lid Up Position** and **Lid Down Position**, at a certain frequency, **Lid Up Time** and **Lid Down Time**. This mechanism helps to accelerate the rate of reaction, improve uniformity, and disperse air bubbles. Additionally, set the **Threshold** temperature to stop agitation above a certain temperature set point.

*Note: Agitation angles must be set in consideration of the reagent volume. Agitation frequency must be set in consideration of the incubation time and temperature.*

Agitation Parameters

Lid Up Position: Inject      Lid Up Time: 00:00:01

Lid Dn Position: A4      Lid Down Time: 00:00:59

Threshold (°C): 71

Cancel      OK

Figure 93

**Wash Buffer Type and Wash Buffer.** Select the quick wash reagent. A quick wash is executed immediately at the end of incubation and will agitate twice automatically. The default reagent is set to System Fluid (wash buffer).

**# and Volume.** Select the number and volume of quick washes.

*Note: The quick wash ensures that the reagent is promptly removed at the end of the Step without interruption from other processes running in the same staining run. Include a quick wash or linked wash step to control time-sensitive incubation steps (within minutes).*

## Configuring the Protocol Editor

Click **“Protocol Editor Config”** to configure the main Protocol Editor window. This feature may be used when configuring the system for new protocol types.

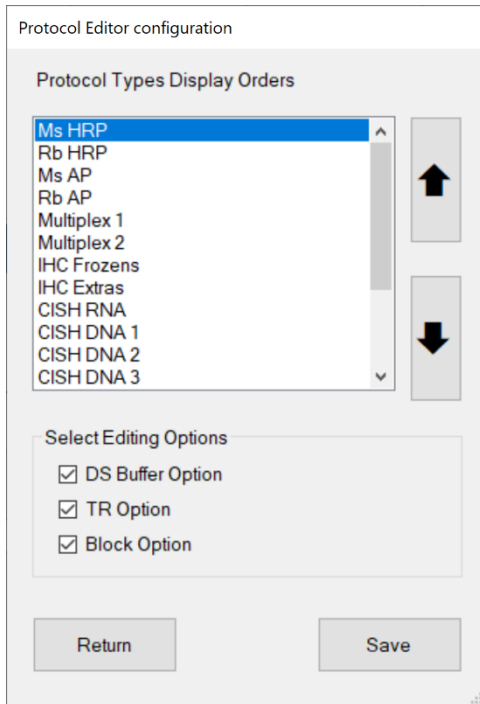

Figure 94

Adjust the **Protocol Types Display Order** using the up/down arrows to change the order of the tabs displayed in the **Protocol Editor**. The display order can be changed to prioritize frequently used protocol types.

*Note: Remove unnecessary Protocol Types by deleting all reagents of that type in the Reagent Editor.*

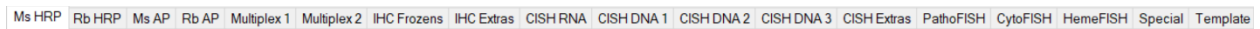

Figure 95

Configure **Select Editing Options** to change the customization options for each tab in the Protocol Editor.

Select the Protocol Type from the list and select the desired options:

DS Buffer Option

AR Option

Block Option

DS Buffer Option	AR Option	Temp. (°C)	Block Option	Reagent Name	Time Hour	Min.	Temp. (°C)
DS2-50	AR1, high pH	101	Buffer	Bcl-6	0	30	25
DS Buffer	AR1, high pH	101	Buffer	CD138	0	30	25
DS2-50	AR1, high pH	103	Buffer	CD15	0	59	25
DS Buffer	AR2, low pH	101	Buffer	CD20	0	30	25

Figure 96

*Note: The Control Reagent option is always displayed and is set by the protocol template.*



## Importing Protocols in the PR Manager

Export packages are periodically released to the user in order to 1) update protocol templates and protocols, 2) add additional applications and products, or 3) add special protocols. These packages may be imported into the system using the PR Manager utility. *Contact Technical Support for more information.*

Click “**Protocol Reagent Manager**” to open the **Protocol and Reagent Manager** utility.  
Login with the User ID and Password.

From the Import tab, click “**Browse**” and select an export package (compressed zip folder).

 **Note: Do not unzip/extract the export package.**

*Tip: It is advised to make a backup copy of the data before making upgrades to the SW or protocols.  
Please contact Technical Support for assistance.*

The new protocol(s)/template(s)/special protocol(s) to be imported are listed under **Import Protocols**.

The associated reagent(s) to be imported are listed under **Import Reagents**.

The associated negative control link(s) to be imported are listed under **Import Negative Control**.

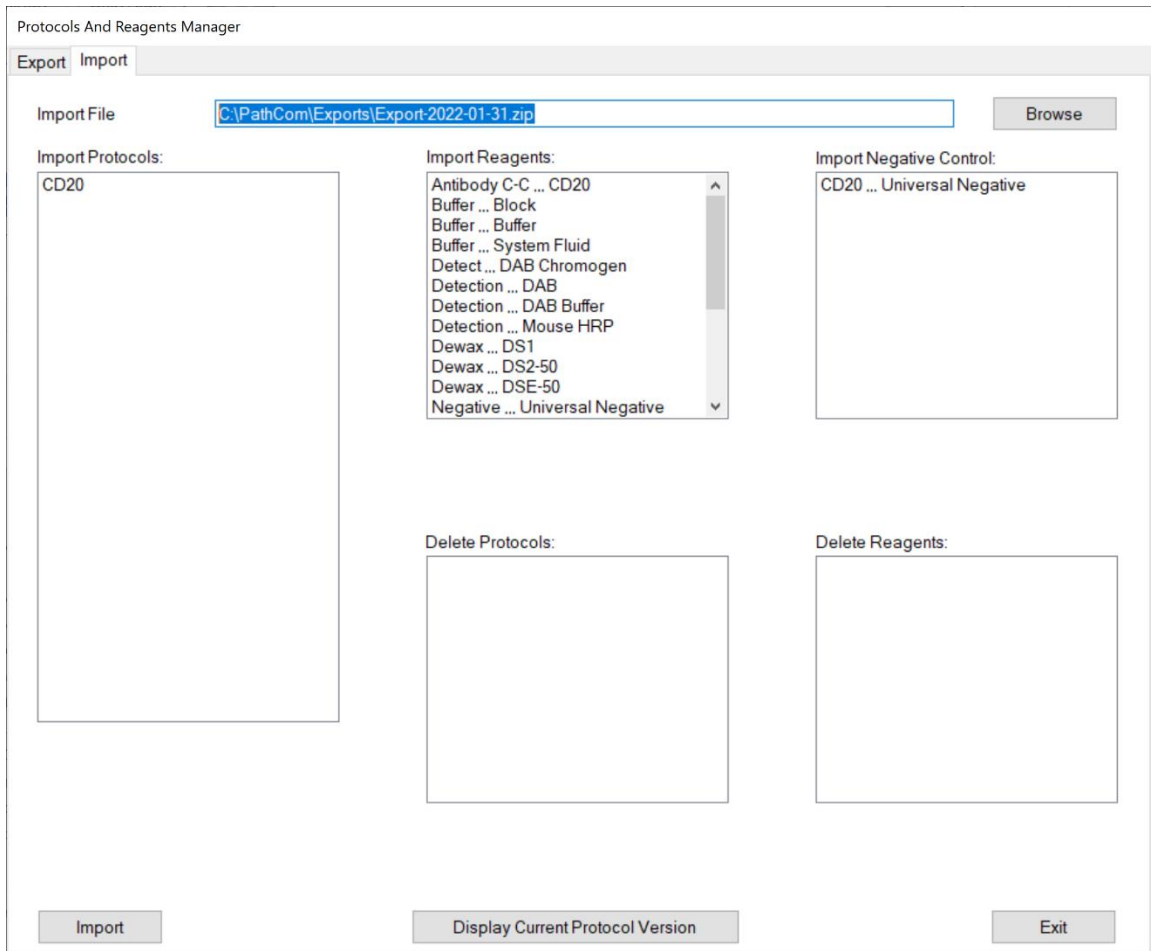





Figure 97

*Note: The manufacturer may use the export function to remove obsolete protocols and discontinued products. The protocols to be deleted are listed under **Protocols to Delete**. The reagents to be deleted are listed under **Reagents to Delete**.*

Click **"Import"** to import the contents of the export package. A status bar will be displayed to show the progress of the import process.

  **After the system has imported a new protocol, the system will automatically refresh all protocols. Save all customizations before performing an import, otherwise, some recent protocol modifications may be lost.**

All new protocols, templates and reagents will be added to the system.

 **All existing protocols or templates that share the same name as an imported protocol will be overwritten.**

 **All existing reagents that share the same name as an imported reagent will be overwritten.**

*Note: Protocols cannot be transferred between different protocol versions. The protocol import process will abort if the current protocol version number does not match the version number of the export package. Please update to the latest protocol version before importing a new protocol package.*

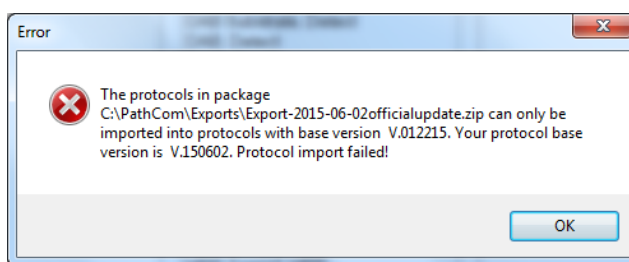



Figure 98

Click **"Display Current Protocol Version"** to view the current protocol version number. The version number will automatically update after importing a manufacturer's protocol update.

 **The manufacturer's protocol updates must be imported in sequential order. The current protocols must be up-to-date before installing the next manufacturer's release.**

Click **"Exit"** to close the utility.

### **Exporting Protocols in the PR Manager (Distributor Access only)**

Click **"Protocol Reagent Manager"** to open the Protocol and Reagent Manager utility. Login with the User ID and Password.

Click the Export tab to view the export options:

Click **"Browse"** to designate the **From Folder** containing the protocol(s) to be exported.

Click **"Browse"** to designate the destination **Export Folder** for the export package.

Enter the **Export File Name**.

Select the protocol(s) to be exported under Available Protocols to Export.

*Note: Protocols of different detection types, Templates or Special protocols may be selected using the dropdown list for **Type**.*

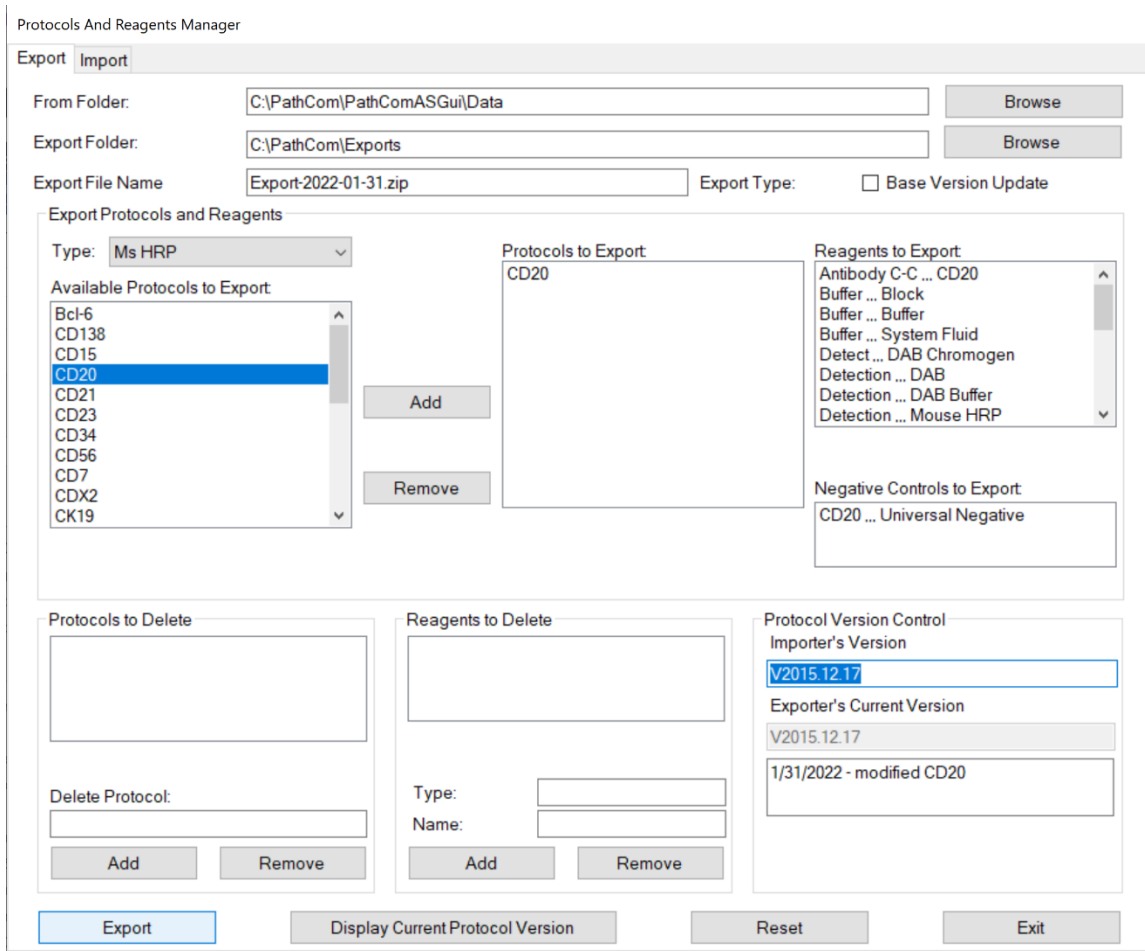

Figure 99

Click **“Add”** and **“Remove”** to modify the list of **Protocols to Export**.  
 The **Reagents to Export** and **Negative Controls to Export** are automatically added.

Ensure that the **Importer’s Version** and **Exporter’s Current Version** Control numbers match.  
 Alternately, select the option **Base Version Update** to change the **Importer’s Version** Control number upon import of the package.

Click **“Export”** to create an export package in the designated destination folder.

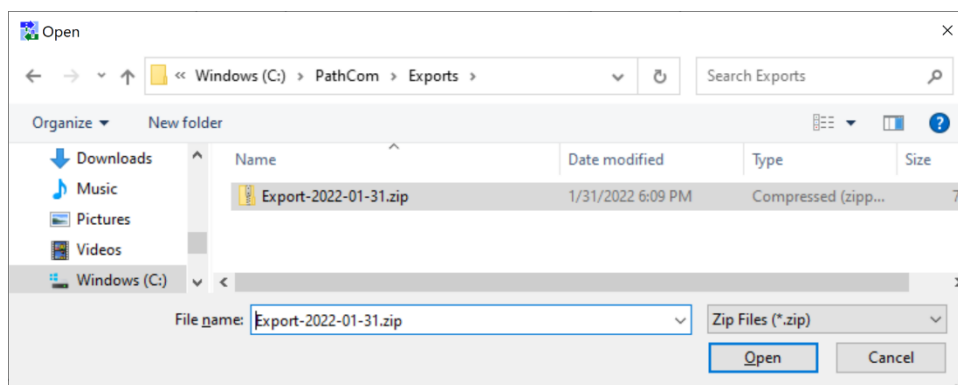

Figure 100

## Adding New Reagents in the Reagent Editor

The user has the option to add third-party antibody products or other approved reagents to the system. This may be necessary when certain reagents are not offered in the Oncore Pro product line.

Click “**Reagent Editor**” to view and manage the system’s reagents.

*Note: The reagent list may vary based on the system configuration and user’s security access level.*

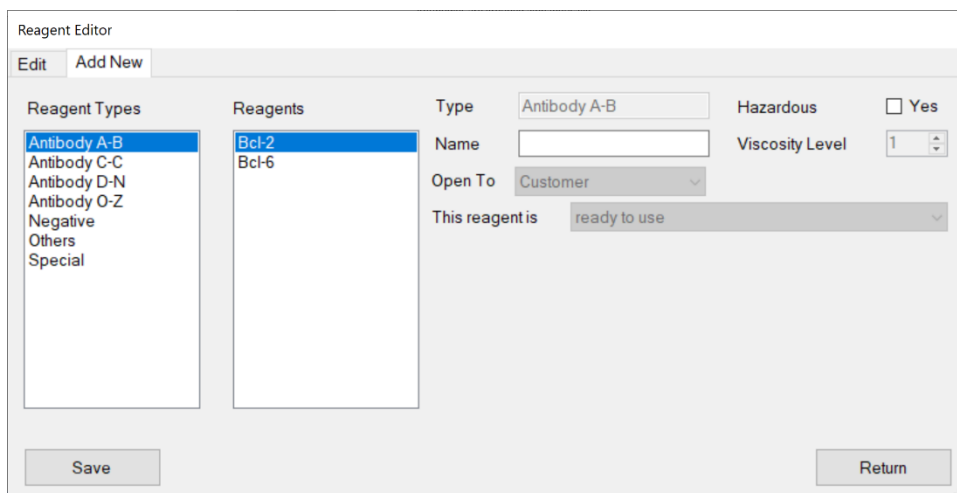

Figure 101

**To add a new antibody (or antibody titration),** select the Add New tab.

Select the Antibody group listed under **Reagent Types**. Antibodies are grouped alphabetically.

Input a unique antibody name in the **Name** field.

**⚠ Each unique antibody product must have a unique name i.e.: different clone #, manufacturers, dilutions etc.**

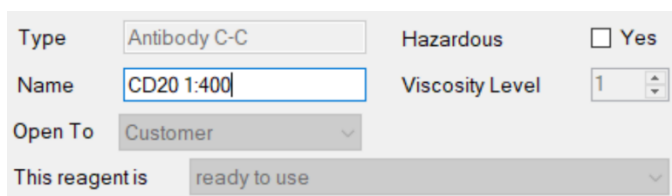

Figure 102

The option “**Open To**” is set by default to the user’s security access level.

The option “**This reagent is ready to use**” is set by default.

This field stores the mixing parameters of the reagent.

Check the box **Hazardous** to designate the reagent as hazardous, if needed.

All hazardous waste will be dispensed in the designated hazardous waste station.

The **Viscosity Level** is automatically set to 1 by default.

This field determines the liquid handling parameters of the reagent.

Click “**Save**” to add the new antibody to the system.

To add a new reagent, select the Add New tab.

Select Negative, Others or Special under **Reagent Types**.

*Note: The list of available reagent types may vary based on the system configuration.*

Input a unique reagent name in the **Name** field.

 **Contact Technical Support before using third-party reagents. Certain reagents may be chemically incompatible and may cause damage to the instrument.**

The option “**Open To**” is set by default to the user’s security access level.

Set the mixing parameters of the reagent:

- A. Select the option “**This reagent is ready to use**” for reagents applied directly to the slide.
- B. Select the option “**This reagent is mixed on-board with the following parameters**” for 2 reagents to be mixed directly on the slide. Reagent mixtures that have a short activity time must be mixed on-board.

*Note: Reagent A and B should have a low mixing ratio, i.e.: 1: 1.*

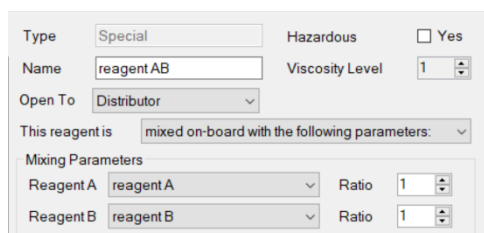

The screenshot shows a configuration form for a reagent. The 'Type' is set to 'Special'. The 'Name' is 'reagent AB'. The 'Open To' is 'Distributor'. The 'Hazardous' checkbox is unchecked. The 'Viscosity Level' is 1. The 'This reagent is' dropdown is set to 'mixed on-board with the following parameters:'. Under 'Mixing Parameters', 'Reagent A' is 'reagent A' with a 'Ratio' of 1, and 'Reagent B' is 'reagent B' with a 'Ratio' of 1.

- C. Select the option “**This reagent is mixed on-rack with the following parameters**” for 2-3 reagents to be mixed on the reagent rack in a separate mixing vial before application to the slide.

*Note: Reagent A, B (and C optional) may have a higher mixing ratio, i.e.: 1:20 or 1:30; however, the user must set an appropriate minimum mixing volume to ensure the compositional accuracy of the mixture. The maximum mixture volume must not exceed 16mL.*

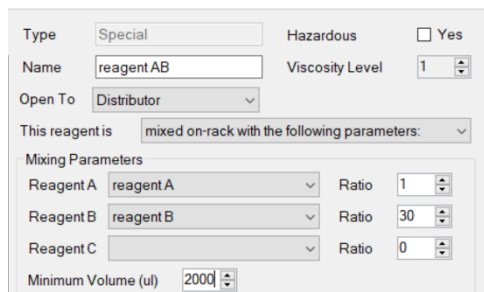

The screenshot shows a configuration form for a reagent. The 'Type' is set to 'Special'. The 'Name' is 'reagent AB'. The 'Open To' is 'Distributor'. The 'Hazardous' checkbox is unchecked. The 'Viscosity Level' is 1. The 'This reagent is' dropdown is set to 'mixed on-rack with the following parameters:'. Under 'Mixing Parameters', 'Reagent A' is 'reagent A' with a 'Ratio' of 1, 'Reagent B' is 'reagent B' with a 'Ratio' of 30, and 'Reagent C' is empty with a 'Ratio' of 0. The 'Minimum Volume (ul)' is 2000.

Check the box **Hazardous** to designate the reagent as hazardous, if needed.

Set the **Viscosity Level**. Refer to the Specialist User Manual for more details.

Click “**Save**” to add the new reagent to the system.

To edit or remove an existing antibody or reagent, select the Edit tab.

Select the reagent from the list under the appropriate Reagent Type and edit the available fields, as needed.

*Note: Users granted Supervisor access may only edit reagents **Open To Customer**.*

*Reagents designated Distributor or Closed are protected by the system and cannot be modified or removed.*

*Contact Technical Support for assistance.*

The screenshot shows the 'Reagent Editor' window with the 'Edit' tab selected. On the left, there are two lists: 'Reagent Types' and 'Reagents'. 'Antibody C-C' is selected in the 'Reagent Types' list, and 'CD20 1:400' is selected in the 'Reagents' list. The right side of the window contains several input fields: 'Type' is 'Antibody C-C', 'Name' is 'CD20 1:400', 'Open To' is 'Customer', and 'This reagent is' is 'ready to use'. There are also checkboxes for 'Hazardous' (unchecked) and 'Viscosity Level' (set to 1). At the bottom, there are three buttons: 'Save', 'Delete', and 'Return'.

Figure 103

Click **“Delete”** to delete the reagent from the system, as needed.

*Note: The reagent cannot be deleted if it is used in an existing protocol on the system.*

Click **“Return”** to exit.

### Preparing RFID Reagent Tags with the RFID Tag Editor

The system offers user-programmable vials for use with the user’s custom reagents and third-party antibodies. Each programmable vial contains an RFID tag which will store all the information associated with that reagent. The RFID tag may be reprogrammed for multiple uses, if needed.

Load the removable vial holder into bottom right corner of the reagent rack and then load the rack onto the instrument.

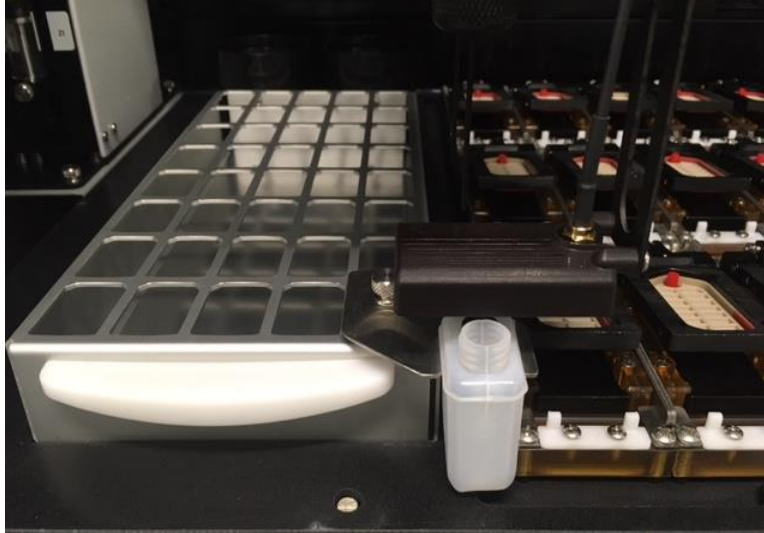

Close the door and click “RFID Editor” to launch the **RFID Tag Editor**. The robotic arm will position the RFID antenna over the vial holder. Place a user-programmable vial in the vial holder and remove the cap.

<input type="button" value="Read Tag"/>	<input type="button" value="Show RFID Com"/>	<input type="button" value="Write Tag"/>
<input type="checkbox"/> Use Robot and Reagent Rack	<input type="checkbox"/> Get Reagent List From File	
<input type="text" value="E00402005491BF5B"/>	Tag ID	<input type="text" value="E00402005491BF5B"/>
<input type="text" value="Antibody C-C"/>	Reagent Type	<input type="text" value="Antibody C-C"/>
<input type="text" value="CD20"/>	Reagent Name	<input type="text" value="CD20"/>
<input type="text" value="15ml"/>	Bottle Type	<input type="text" value="15 ml"/>
<input type="text" value="60"/>	Number Of Tests	<input type="text" value="60"/>
<input type="text" value="20220131"/>	Lot Number	<input type="text" value="20220131"/>
<input type="text" value="202301"/>	Expiration Code (yyyyymm)	<input type="text" value="202301"/>
<input type="text" value="4"/>	Storage Temperature (°C)	<input type="text" value="4"/>
<input type="text" value="---"/>	Manufacturer Name	<input type="text" value="---Add or Remove---"/>
<input type="text" value=""/>	Catalog Number	<input type="text" value=""/>

Figure 104

**To read the information in the RFID tag**, click **“Read Tag”**.

The programmed information will be displayed in the empty fields to the left.

*Note: Brand-new RFID tags will not be read correctly, as they do not contain any data, only the tag manufacturer’s randomly generated Tag ID.*

**To write information into the RFID tag**, complete the entry fields to the right and click **“Write Tag”**.

Select the **Reagent Type** and **Reagent Name** from the drop down lists.

*Note: Users with Supervisor access may only select user-added reagents and reagents Open To Customer.*

*Some reagents are restricted by the manufacturer and may not appear on the user-programmable reagent list.*

Select the appropriate **Bottle Type** (15 or 7 mL).

The bottle type is required to ensure accurate liquid detection.

*15 ml vials should be programmed for 60 tests, while 7 ml vials should be programmed for 30 tests.*

*All vials must be filled properly to the line indicated.*

Enter the **Storage Temperature**.

Enter the **Number of Tests Left**.

*Note1: The system may permit the user to reuse/reprogram user-programmed vials.*

*Please ensure vials are thoroughly cleaned and dried before re-use.*

*Note2: The system may block access for reprogramming reagent kit vials.*

Enter the **Lot Number (up to 12 characters)** and **Expiration Code (yyymm)**.

(Optional) Select the **Manufacturer Name**.

*Note: Select “---Add or Remove---”, from the dropdown menu to add a new reagent manufacturer name.*

(Optional) Enter the **Catalog Number**.

The system will immediately read the tag after writing to verify and display the data in the left field.



**Do not remove the vial until the tag ID on the left is highlighted in green to indicate that the tag has been read successfully.**

*Note: The system will give a warning if the user chooses to re-use a programmed vial.*



## Assigning Negative Controls

All protocols (except Special) are automatically generated with a corresponding negative control protocol. All steps of the protocols are identical except the primary reagent which is substituted with the negative control reagent. The negative control is set to **Universal Negative** by default.

Click “**Negative Control Editor**” to manage and assign negative controls for each protocol.

Note: Add new negative control reagents in the Reagent Editor, under reagent type Negative.

Refer to *Reagent Editor*, p. 75 for more information on adding new reagents.

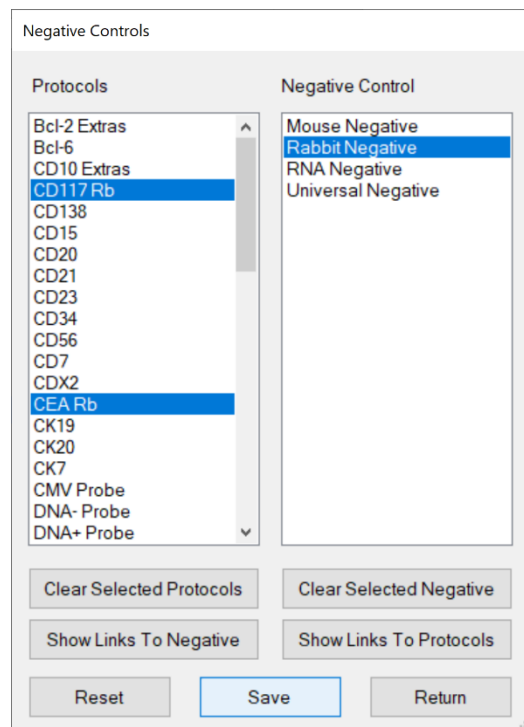

Figure 105

**To view all protocols assigned to a negative control**, select the negative control from the list and click “**Show Links to Protocols**”. All protocols linked to the negative control will be highlighted under **Protocols**.

Click “**Clear Selected Protocols**” to clear the protocol selection(s) displayed on the screen.

**To view the negative control assigned to a protocol**, select the protocol from the list and click “**Show Links to Negative**”. The negative control linked to the protocol will be highlighted under **Negative Control**.

Click “**Clear Selected Negative**” to clear the negative control selection displayed on the screen.

**To assign a negative control to a protocol**, select the protocol(s) listed under **Protocols** and select a negative control reagent listed under **Negative Control**.

*Tip: Hold down the Ctrl key to select multiple protocols.*

**To change the negative control assignment of the protocol**, select the protocol(s) listed under Protocols and select a different negative control reagent.

*Note: The user cannot remove a negative control assignment, only change it. A negative control must always be selected for every protocol.*

Click “**Save**” to link the selected protocol(s) to the negative control.

Click “**Reset**” to reset all assignments back to the default negative control, Universal Negative.

## Creating Custom Groups

Click **“Custom Group Editor”** to edit/create custom lists of protocols for quick access to protocols in the **Barcode Label Editor**. Refer to **Add New Labels in the Barcode Label Editor**, p. 19, for more information.

Select a custom group from the dropdown list **Custom Group Name**.  
Protocols in the custom group will be listed under Selected Protocols.

**To add a custom group**, click **“Add New Custom Group”**, enter a New Custom Group Name, and click **“Add”**.

**To add protocol(s) to a custom group**, select protocol(s) from the list under Available Protocols, click **“Add Protocol”**, and click **“Save”**.

**To remove protocol(s) from a custom group**, select the protocol(s) from the list under Selected Protocols, click **“Remove Protocol”**, and click **“Save”**.

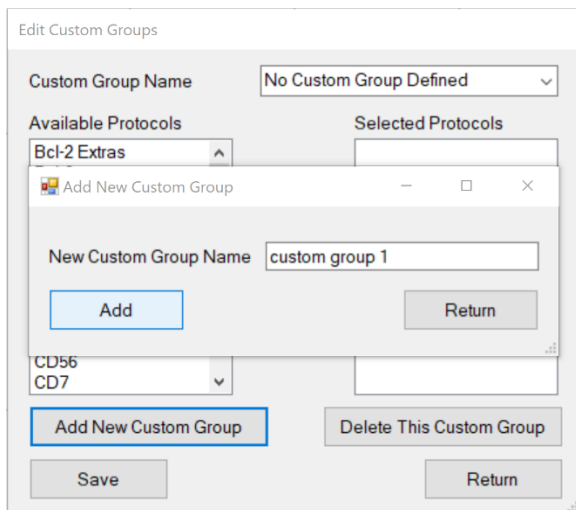

Figure 106

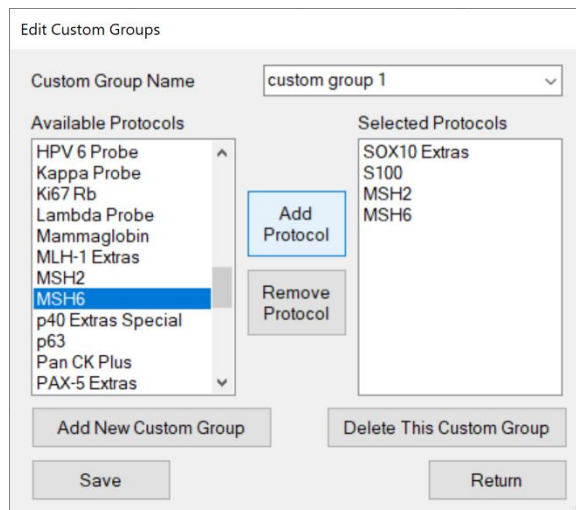

Figure 107

**To delete a custom group**, select the group from the dropdown list Custom Group Name and click **“Delete This Custom Group”**.

Click **“Return”** to exit the Custom Group Editor.

## Creating Custom Panels

Click **“Panel Editor”** to edit/create custom panels of protocols accessible in the **Barcode Label Editor**. Refer to **Add New Labels in the Barcode Label Editor**, p. 19, for more information.

Select a panel from the dropdown list **Panel Name**.

Protocols in the panel will be listed under **Selected Protocols**.

**To add a new panel**, click **“Add New Panel”**, enter a New Panel Name, and click **“Add”**.

**To add protocol(s) to a panel**, select the protocol(s) from the list under **Available Protocols**, click **“Add Protocol”**, and click **“Save”**.

*Note: The user may choose to add a positive and/or negative control with each protocol if desired.*

**To remove protocol(s) from a panel**, select the protocol(s) from the list under **Selected Protocols**, click **“Remove Protocol”**, and click **“Save”**.

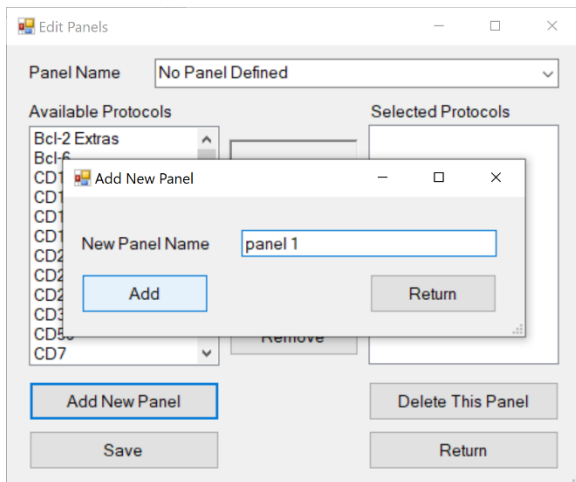

Figure 108

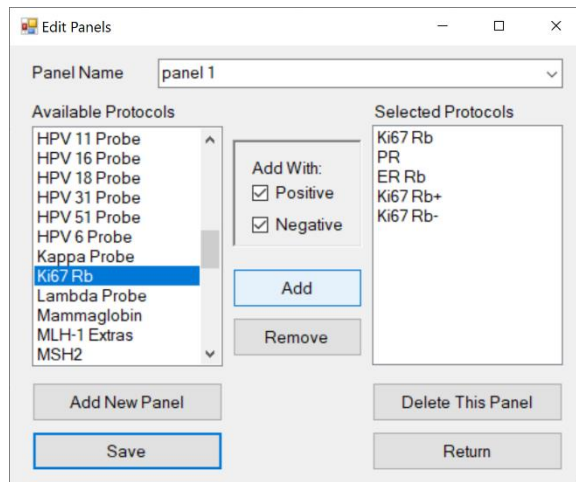

Figure 109

**To delete a panel**, select the panel from the dropdown list **Panel Name** and click **“Delete This Panel”**.

Click **“Return”** to exit the Panel Editor.

## 5.3. Security

Manage system security features under the “**Security**” tab.



Figure 110

### Change Password

Click “**Change Password**” to change the current user login password.

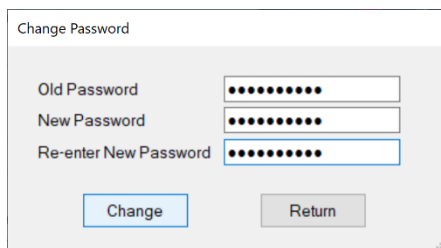

Figure 111

### User Administration

Click “**User Administration**” and login to view the list of users.

To add a new user, click “**Add User**” to open the “**Add User**” window.

Enter the **Name**, **User ID** and **Password** and set the **Access Level**.

*Note: Only users with Distributor or Supervisor access level may create additional user accounts.*

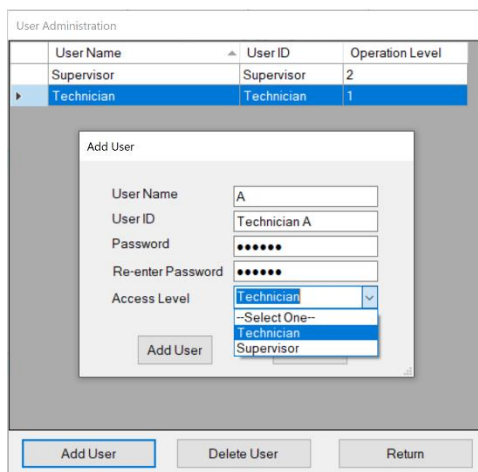

User Name	User ID	Operation Level
Supervisor	Supervisor	2
Technician	Technician	1

Add User

User Name: A

User ID: Technician A

Password: [Redacted]

Re-enter Password: [Redacted]

Access Level: Technician

Add User

Figure 112

**Technician** (customer) level will grant access limited to the essential features needed for routine operation of the instrument.

**Supervisor** (customer) level will grant access to more advanced features needed to configure and customize the instrument.

**Distributor** level (manufacturer) will grant full access to Tools, Editors, Security and Settings.

To remove a user, select the user in the grid and click “**Delete User.**”

## 5.4. Settings

View system information and adjust system settings under the “Settings” tab.

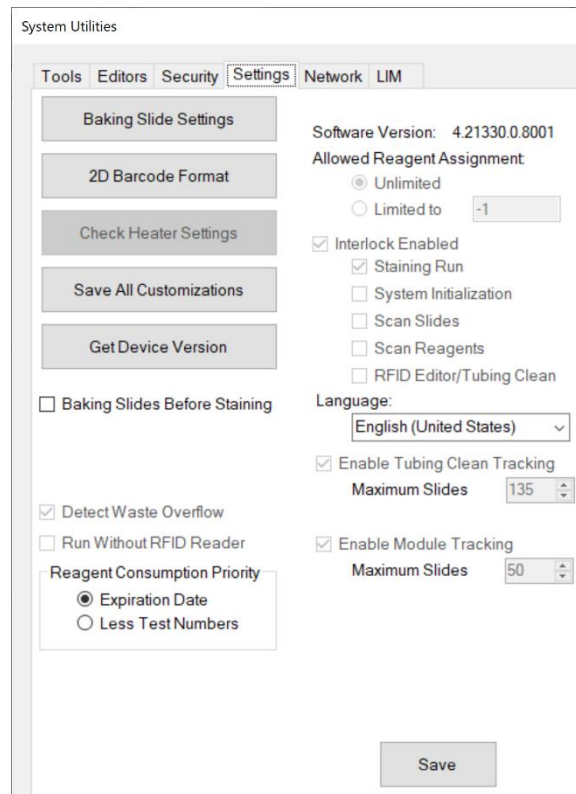

The screenshot shows the 'System Utilities' window with the 'Settings' tab selected. The window contains several sections of controls:

- Navigation Buttons:** Baking Slide Settings, 2D Barcode Format, Check Heater Settings, Save All Customizations, Get Device Version.
- Software Information:** Software Version: 4.21330.0.8001.
- Allowed Reagent Assignment:** Radio buttons for 'Unlimited' (selected) and 'Limited to' (with a value of -1).
- Interlock Enabled:** A checked checkbox with sub-options: Staining Run (checked), System Initialization (unchecked), Scan Slides (unchecked), Scan Reagents (unchecked), and RFID Editor/Tubing Clean (unchecked).
- Language:** A dropdown menu set to 'English (United States)'. Below it is a checked checkbox for 'Enable Tubing Clean Tracking' with a 'Maximum Slides' spinner set to 135.
- Tracking:** A checked checkbox for 'Enable Module Tracking' with a 'Maximum Slides' spinner set to 50.
- Other Settings:** 'Baking Slides Before Staining' (unchecked), 'Detect Waste Overflow' (checked), 'Run Without RFID Reader' (unchecked), and 'Reagent Consumption Priority' (radio buttons for 'Expiration Date' selected and 'Less Test Numbers' unselected).
- Save Button:** A 'Save' button at the bottom right.

Figure 113

### Baking Slide Settings

Click “Baking Slides Settings” to set the Temperature (°C) and Baking Time (Minute). Click “Save” and “Return”.

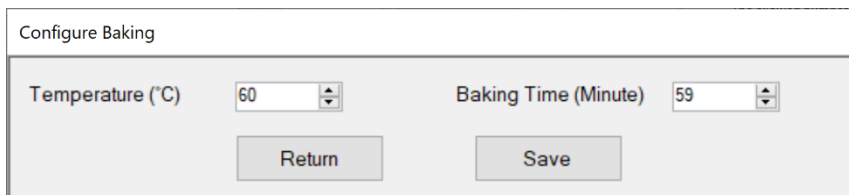

The screenshot shows the 'Configure Baking' dialog box with two input fields and two buttons:

- Temperature (°C):** A spinner box set to 60.
- Baking Time (Minute):** A spinner box set to 59.
- Buttons:** 'Return' and 'Save' buttons.

Figure 114

## 2D Barcode Format

Click “**2D Barcode Format**” to open the “**Barcode Label Options**” and edit settings for the Barcode Label Editor.

Select the option for the **Date Format**.

Select the option **Copy Patient Information to New Record** to retain the patient information from the previous set of labels for the next set of labels in the Barcode Label Editor.

Figure 115

### (For LIS systems only)

Select the option **Show Slide UID** to display the unique slide ID received from the LIS system in the Slide Label Editor. This allows the user to identify slides ordered by the LIS system.

Select the option **Print Barcode Using Slide UID** to generate the 2D barcode label using the unique slide ID received from the LIS system instead of the system-generated ID.

Select the option **Record from LIS use LIS label format** to use LIS label formatting.

Configure the layout of the label. Refer to **Label Format**, p. 83.

Manage the list of doctor names that appears in the Barcode Editor. Refer to **Edit Doctor Name List**, p. 84.

Enter default **Label** field names for Text Line 1 and Text Line 2 of the label.

Enter a default **Entry** for Text Line 1 and Text Line 2, as needed.

Select the **Printer** name from the dropdown list.

 Ensure that a compatible label printer is connected and selected in the **Printer** dropdown list.

Adjust the **Top** and **Left Margins**, as needed.

Adjust the print **Width**, **Dark Level** and print **Speed**, as needed.

Click “**OK**” to close the window.

The default label print-out is displayed below for Label Style #1.

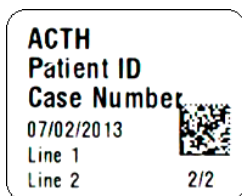

Figure 116

<b>ProtocolName</b>	
<b>PatientID</b>	
<b>CaseNum</b>	
<b>DateTimeEntry</b>	<b>2D Barcode</b>
<b>TextLine1</b>	
<b>TextLine 2</b>	<b>m/n</b>

## Label Format

Click “**Label Format**” in the Barcode Label Options to open the **Label Formatter** and edit the printable data on the label. Select the type of label to be formatted from the **Label Format** dropdown list:

**Record Entered Locally** configures the labels input directly on the system.

**Record Received from LIS** configures the labels generated by the LIS system

The screenshot shows the 'Label Formatter' window with the 'Label Format' dropdown set to 'Record Entered Locally'. Below this, the 'Label Style #1 Size 0.9 x 0.75' is selected. The main area contains a preview of a label with the following fields: 'ProtocolName' (dropdown), 'PatientID' (dropdown), 'CaseNum' (dropdown), 'DateTimeEntry' (dropdown), 'TextLine1' (dropdown), and 'TextLine2' (dropdown) with the value 'm/n'. A 2D barcode is positioned to the right of the 'CaseNum' and 'DateTimeEntry' fields. At the bottom, there are 'Save' and 'Return' buttons.

Figure 117

The screenshot shows the 'Label Formatter' window with the 'Label Format' dropdown set to 'Record Received from LIS'. Below this, the 'Label Style #1 Size 0.9 x 0.75' is selected. The main area contains a preview of a label with the following fields: 'ProtocolName' (dropdown), 'PatientIDExternal' (dropdown), 'ContainerIdentifier' (dropdown), 'DateTimeEntry' (dropdown), 'ReceivingFacility' (dropdown), and 'AttendingDoctor1' (dropdown) with the value 'm/n'. A 2D barcode is positioned to the right of the 'ContainerIdentifier' and 'DateTimeEntry' fields. At the bottom, there are 'Save' and 'Return' buttons.

Figure 118

Select the **Label Style** to change the layout of the label.

Select the data field identifier for each line of the label.

The user may change the order and type of data to be printed on each line of the label.

*Note: Some data types are only available for use with an LIS system.*

Click “**Save**” to save changes to the label format.

*Note: Please verify that the printed data will not overlap with the 2D barcode label.*

## Edit Doctor Name List

Click “**Edit Doctor Name List**” in the Barcode Label options to display the list and add/remove entries.

To add a new doctor, enter a new name and click “**Add**”.

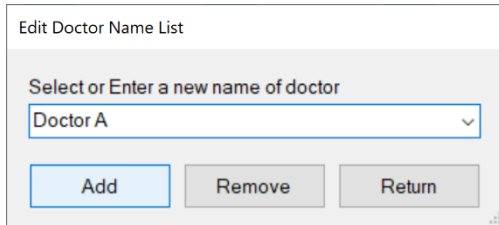

Figure 119

To remove an existing doctor, select a name from the dropdown list and click “**Remove**”.

## Check Heater Settings

The manufacturer configures the temperature, tolerance, and time for the heater check function.

## Save All Customizations

Click “**Save All Customizations**” to back up all protocol customizations in the **Protocol Editor**.



**The previously saved customizations will be overwritten. Therefore, the user should verify all current protocol customizations in the Protocol Editor before proceeding.**

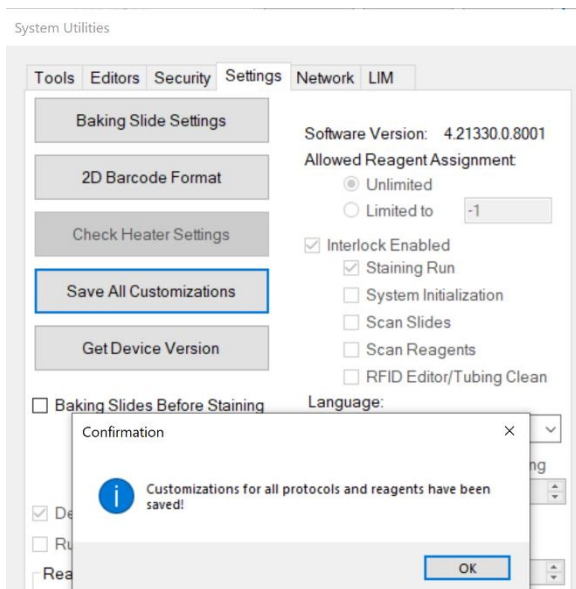

Figure 120

*Tip: The user may restore an individual protocol or a selected group of protocols using the saved protocol customizations by clicking “**Refresh**” from the appropriate tab in the **Protocol Editor**. Alternately, the user may restore all protocol customizations by clicking “**Refresh All Protocols**” from the **Template** tab in the **Protocol Editor***

## Device Version

Click “**Get Device Version**” to view the system device information.



### Baking Slides Option

Check the box **Baking Slides Before Staining** to set the system to automatically begin baking slides before the start of every staining run. Set the time allotted for cool down after baking. Click **“Save”**.

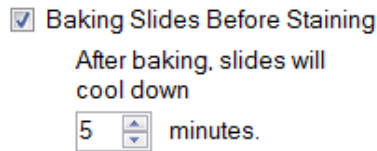

Figure 121

### Detect Waste Overflow Option (Distributor Access only)

Check the box “Detect Waste Overflow” to enable waste overflow detection of the wash stations. Click **“Save”**. When the system detects overflow of a waste station, it will warn the user with a pop-up message and an alarm. If the non-hazardous waste station has overflowed, the system will divert waste to the hazardous waste station.

### Run Without RFID Reader Option (Distributor Access only)

Check the box “Run Without RFID Reader” to disable the RFID Reader. Click **“Save”**. This option should only be used in the event of an RFID reader failure.

### Reagent Consumption Priority

Set the usage priority when multiple vials of the same reagent are scanned during Reagent Check. Click **“Save”**.

The option **“Expiration Date”** will prioritize the consumption of reagents with an earlier expiration date. The option **“Less Test Numbers”** will prioritize the consumption of reagents containing fewer tests.



Figure 122

### Software Version

Contact Technical Support for release notes and information about the latest software updates.

### Allowed Reagent Assignment (Distributor Access only)

Set the allowed number of manually assigned reagent tests. The number must be reset if the user exceeds the limit. Please contact Technical Support for assistance.

### Interlock Options (Distributor Access only)

Set the safety interlock configuration. The interlock may be enabled/disabled for the listed processes. Please contact Technical Support for assistance.

### Language

Select the system operating language from the dropdown list. Click **“Save”**. The system will prompt the user to restart the application to apply the changes.

### Tubing Clean Tracking Option (Distributor Access only)

Check the box **Enable Tubing Clean Tracking** to track the number of slides run since the last tubing clean. Enter the Maximum Slides Run. The count is incremented after each staining run. When the system detects that the counter has exceeded the set threshold, the system will block the user from starting a new staining process until the tubing cleaning has been performed.

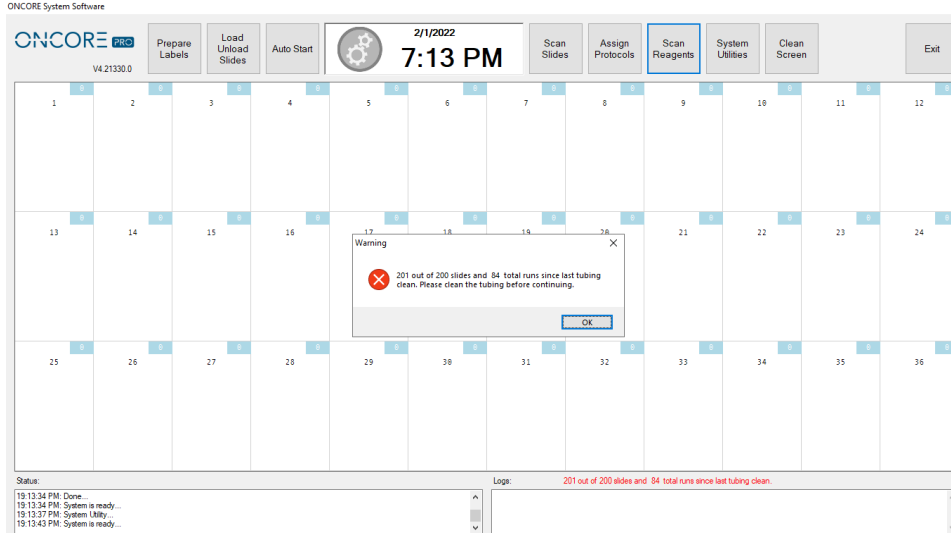

Figure 123

### Module Tracking Option (Distributor Access only)

Check the box **Enable Module Tracking** to track the number of slides run on each module since the last reset. Enter the Maximum Slides Run. The counter for each chamber is displayed on the upper right corner of its grid on the slide map. It is incremented after each staining run. When the counter has exceeded the threshold, it will be highlighted in red to alert the user to replace the chamber(s) and reset the counter.

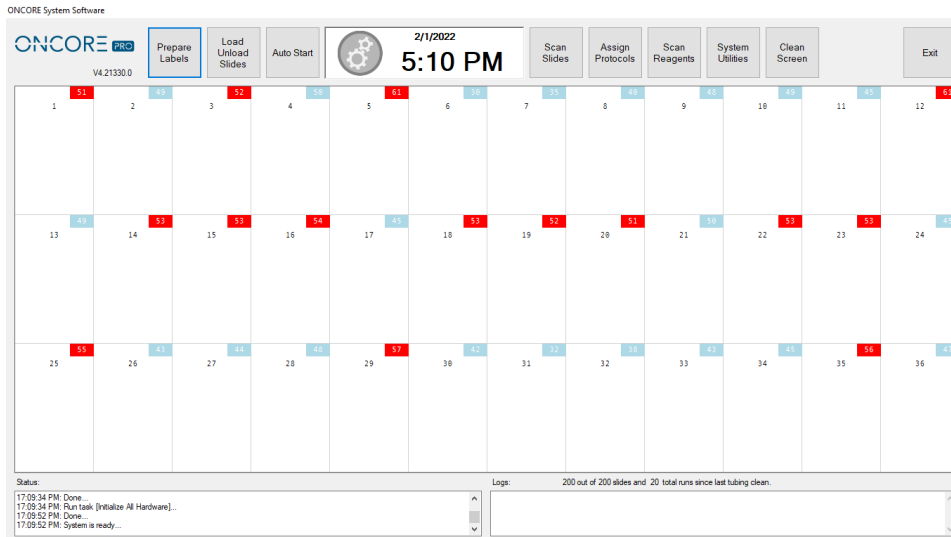

Figure 124

## 5.5. Network

Connect several Slide Stainer systems over the local network under the “**Network**” tab.

The systems connected over the network may print from a dedicated printer on a main PC/server and share 2D barcode label records. Slides may be placed and run interchangeably on all systems connected over the network. *Contact Technical Support to setup the network and connect existing system(s) to the network.*

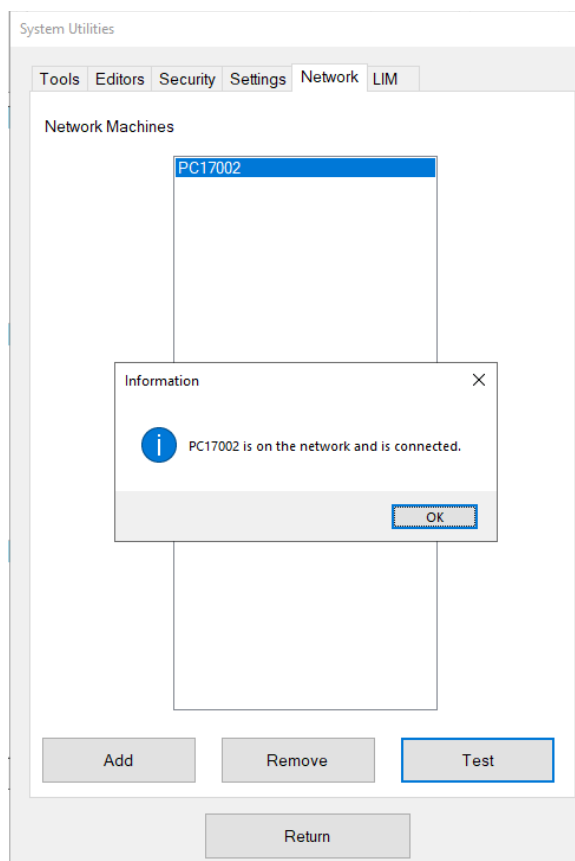

Figure 125

All system(s) connected to the current system will be listed under **Network Machines**.

**To test the connection**, click “**Test Connection**” to check if the current system is properly connected to the selected network machine/main server PC.

**⚠ To avoid unexpected errors, please ensure that all network machines are connected to the network during instrument operation.**

If the connection is not detected, check that all systems are connected to the local network. *Check settings in Windows Control Panel>Network and Internet.*

To add a network machine, click **“Add”**. The system will display a list of **Available Network Machines**.

Select the name of the network machine from the list and click **“Add the selected network machine”**.

*Note: The name of the network machine is the same as the computer name.*

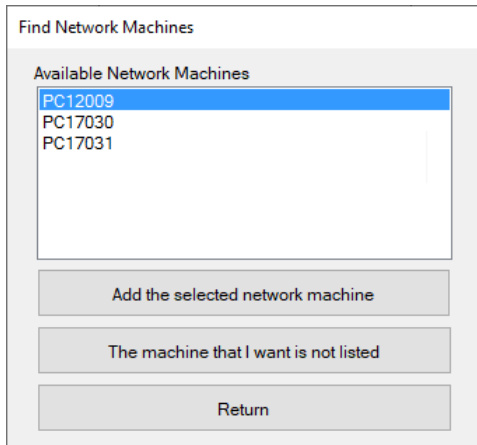

Find Network Machines

Available Network Machines

- PC12009
- PC17030
- PC17031

Add the selected network machine

The machine that I want is not listed

Return

Figure 126

Alternatively, if the machine is not detected, click **“The machine that I want is not listed”** to manually input the network machine name.

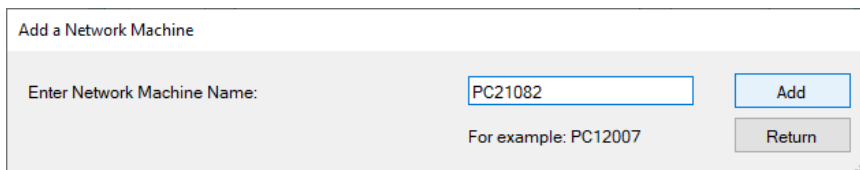

Add a Network Machine

Enter Network Machine Name:

For example: PC12007

Add

Return

Figure 127

Click **“Add”** and input the User ID and Password when prompted.

*Note: Use the computer login ID and password.*

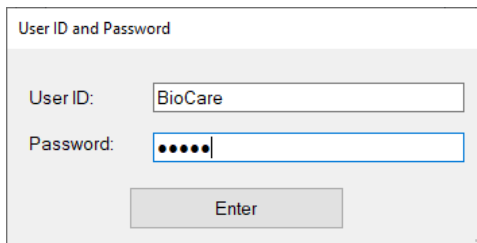

User ID and Password

User ID:

Password:

Enter

Figure 128

To remove a network machine, click **“Remove”**.

To print from a network printer, go to the “Settings” tab and click “2D Barcode Format”.

Select the shared network printer from the Printer dropdown list.  
The printer name will appear preceded by the system name on the network.

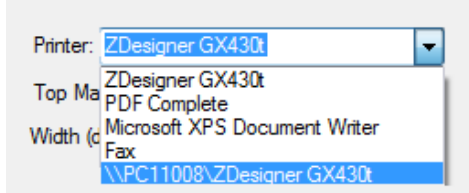

Figure 129

Change the label format options as needed.

**⚠** If the network printer does not appear in the dropdown list of printers, add the network printer to the system in Windows **Devices and Printers** and share the printer.

**⚠** **Do not share more than one printer on the network.** Uncheck any other shared printers, as they may cause unexpected errors.

*Note: If a printed label is not recognized, make sure that all systems are connected to the network, as this will ensure that the record of printed labels is up to date across all systems.*

*Note2: the label records are shared when the label is printed or moved to the printed slides.*

## 5.6. LIS/LIMS

The system supports HL7 Server connection and MSSQL Database connection.  
*Contact Technical Support for more information regarding the setup requirements.*

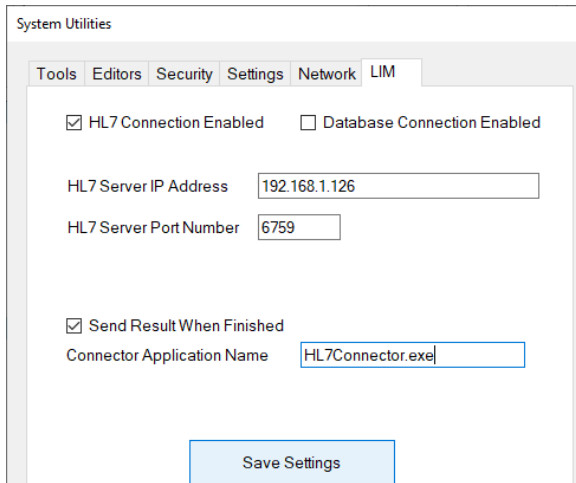

Figure 130

## Section 6. Reports

The system provides a basic report utility to track slides, run sessions, and reagent consumption. From the Main screen, click “**System Utilities**” and open the **Tools** tab to access the Report Generator utility.

### 6.1. Generate a Report

Click “**Generate Reports**” to open the **Report Generator**.

#### Slide Barcode

To track a processed slide by 2D barcode, select the **Slide Barcode** option and click “**Start**”.

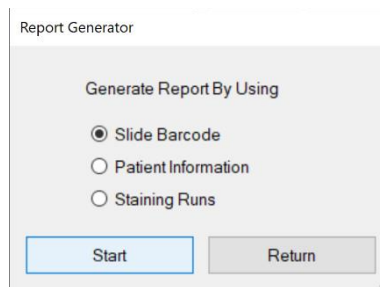

Figure 131

When prompted, place the slide in the selected position 1-36 on the instrument. The 2D barcode reader will scan the unique 2D barcode on the label and trace the slide in the data logs.



Figure 132

- A. Click “**Slide Report**” to generate the report for the scanned slide. Refer to **Report Types**, p.93, for more information.
- B. Click “**Show All Runs For This Slide**” to generate a **Run List** of all runs that include the scanned slide. *Note: The Run List may associate 2 or more runs with a given slide if its run process was interrupted by the continuous loading feature. Each time the instrument is stopped to load more slides, the system must generate a new run schedule and initiate a new staining process.*
- C. Click “**Return**” to return to the previous screen to scan a new slide or select a different option.

From the Run List, the user may choose to:

- i. Select a run by clicking the empty grid in the leftmost column (the row will be highlighted in blue). Click **“Show All Slides in Selected Run”** to generate a **Slide List** of all slides in the selected run.
- ii. Click **“Reagent Usage Report”** to generate a summary of the total reagent usage for all runs in the list.

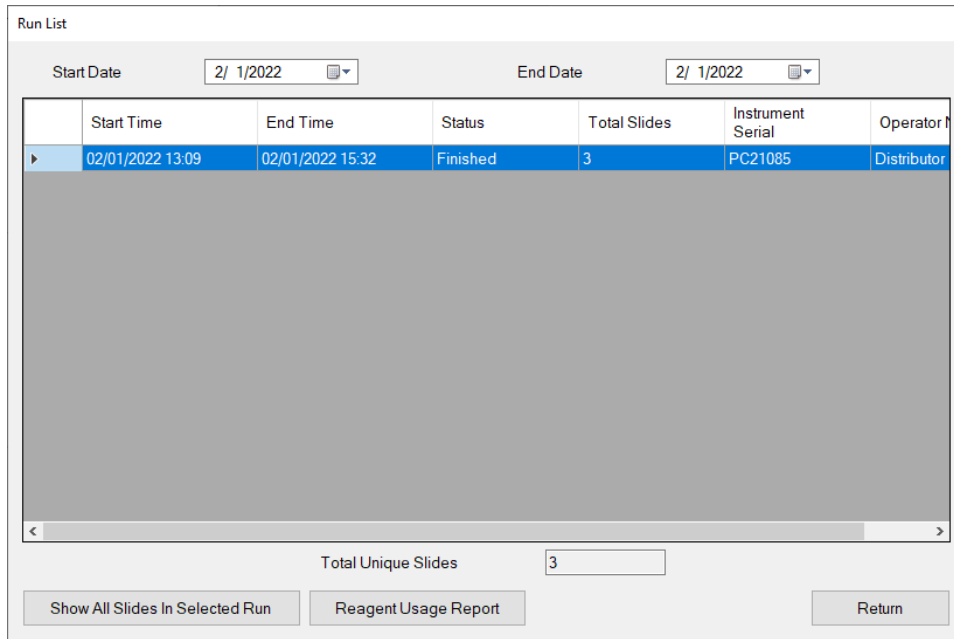

Figure 133

From the Slide List, the user may choose to:

- i. Select another slide in the same run by clicking the empty grid in the leftmost column (the row will be highlighted in blue). Click **“Slide Report”** to generate the report for the selected slide. *Refer to Report Types, p.93, for more information.*
- ii. Click **“Slide Summary Report”** to generate the report for summary of the slides in the run. *Refer to Report Types, p.93, for more information.*
- iii. Click **“Reagent Usage in Run Report”** to generate the report for reagent usage in the run. *Refer to Report Types, p.93, for more information.*

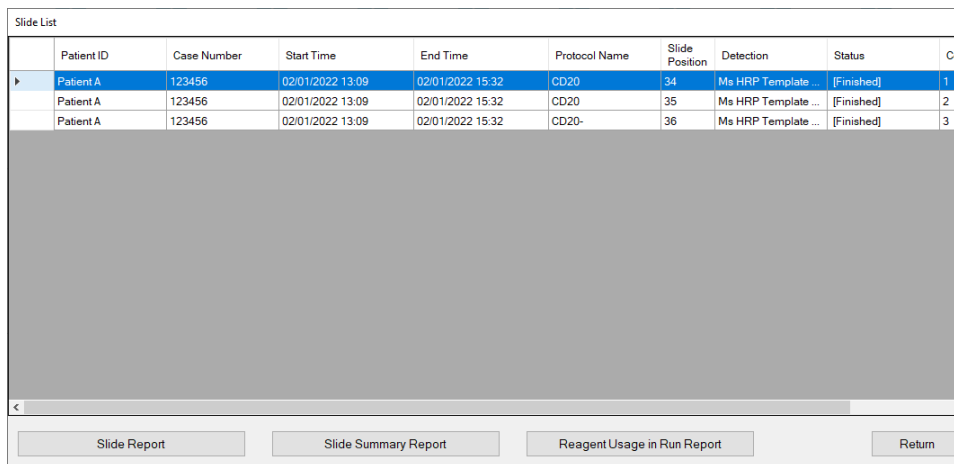
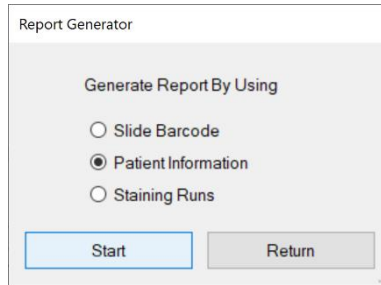

Figure 134

*Note: To obtain a report from a manually assigned slide, select the Staining Runs option. Refer to p. 93 for details.*

## Patient Information

To manually track a processed slide by patient information, select the **Patient Information** option and click “**Start**”.



Report Generator

Generate Report By Using

Slide Barcode

Patient Information

Staining Runs

Figure 135

The system will display all processed slides in the **Patient Information** list. Search the list by entering the Patient ID in the search box, **Search Patient ID**. Sort the list by any column by clicking the column header.

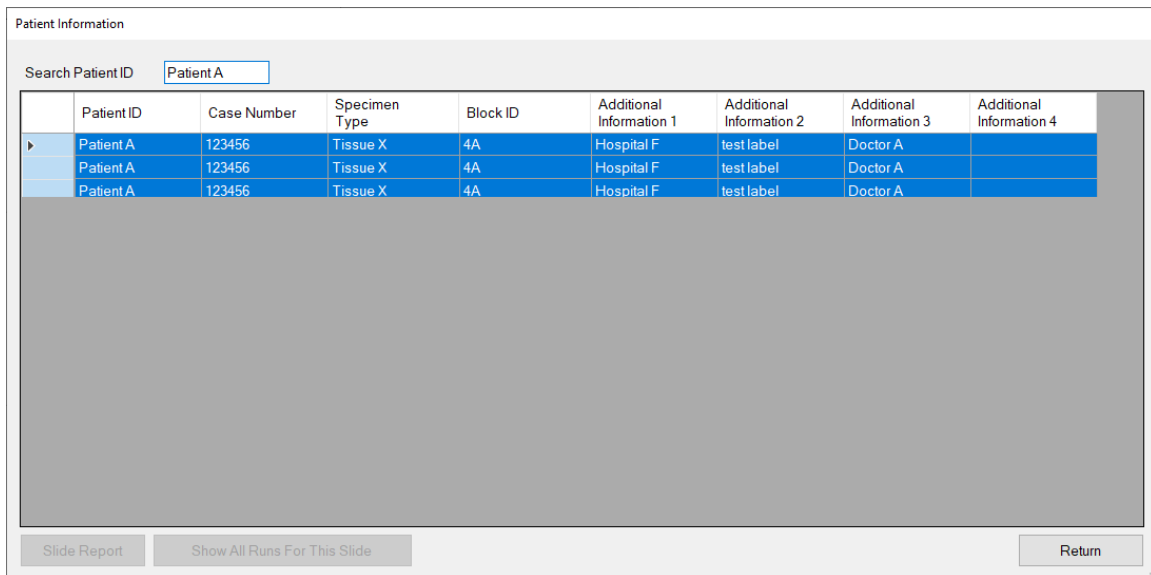

Patient Information

Search Patient ID

	Patient ID	Case Number	Specimen Type	Block ID	Additional Information 1	Additional Information 2	Additional Information 3	Additional Information 4
▶	Patient A	123456	Tissue X	4A	Hospital F	test label	Doctor A	
	Patient A	123456	Tissue X	4A	Hospital F	test label	Doctor A	
	Patient A	123456	Tissue X	4A	Hospital F	test label	Doctor A	

Figure 136

From the Patient Information list, the user may choose to:

- i. Select a slide by clicking the empty grid in the leftmost column (the row will be highlighted in blue). Click “**Slide Report**” to generate the report for the selected slide.
- ii. Select a slide by clicking the empty grid in the leftmost column (the row will be highlighted in blue). Click “**Show All Runs For This Slide**” to generate a Run List of all runs that include the selected slide.



## Staining Runs

To manually track a slide by the run session, select the **Staining Runs** option and click **“Start”**.

*Note: This is the only method for tracking a manually assigned slide.*

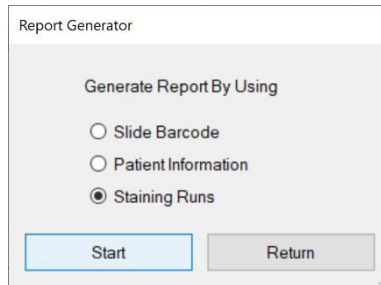

Report Generator

Generate Report By Using

Slide Barcode

Patient Information

Staining Runs

Figure 137

The system will generate a **Run List** of all run sessions. The number of **Total Unique Slides** that have been processed on the system is displayed at the bottom of the list.

Select a **Start Date** and **End Date** to display all runs in a given time period.

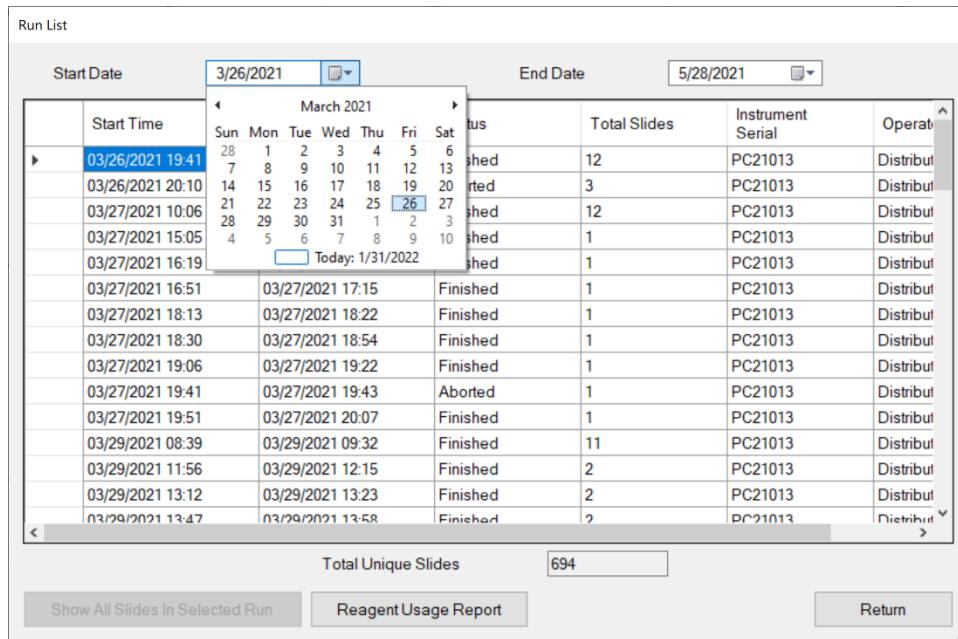

Run List

Start Date: 3/26/2021 End Date: 5/28/2021

Start Time	Status	Total Slides	Instrument Serial	Operat
03/26/2021 19:41	sh	12	PC21013	Distrib
03/26/2021 20:10	orted	3	PC21013	Distrib
03/27/2021 10:06	sh	12	PC21013	Distrib
03/27/2021 15:05	sh	1	PC21013	Distrib
03/27/2021 16:19	sh	1	PC21013	Distrib
03/27/2021 16:51	Finished	1	PC21013	Distrib
03/27/2021 18:13	Finished	1	PC21013	Distrib
03/27/2021 18:30	Finished	1	PC21013	Distrib
03/27/2021 19:06	Finished	1	PC21013	Distrib
03/27/2021 19:41	Aborted	1	PC21013	Distrib
03/27/2021 19:51	Finished	1	PC21013	Distrib
03/29/2021 08:39	Finished	11	PC21013	Distrib
03/29/2021 11:56	Finished	2	PC21013	Distrib
03/29/2021 13:12	Finished	2	PC21013	Distrib
03/29/2021 13:47	Finished	2	PC21013	Distrib

Total Unique Slides: 694

Figure 138

From the Run List, the user may choose to:

- Select a run by clicking the empty grid in the leftmost column (the row will be highlighted in blue). Click **“Show All Slides in Selected Run”** to generate a **Slide List** of all slides in the run.
- Click **“Reagent Usage Report”** to generate a summary of the total reagent usage for all runs listed in the Run List for the selected time period.

## 6.2. Report Types

### Slide Report

The Slide Report provides the run summary for an individual slide. The report can be generated by scanning a slide using the Slide Barcode Option or by selecting a slide from a Slide List or Patient Information list.

The screenshot shows a window titled "Slide Report" with a toolbar at the top containing navigation and zoom controls. The main content area displays the following information:

2/1/2022 5:22:50 PM

Instrument	Operator	Run ID	Slide ID
PC21085	Distributor	us5m26nCGE200k_UMbY4zg	GmCnqX8qskOV34p8Xi7KAq

Patient ID	Case Number	Block ID	Specimen	Additional Information 1	Additional Information 2
Patient A	123456	4A	Tissue X	Hospital F	test label

Protocol Name	Detection	Position	Ctrl	LIS	Start	End
CD20	Ms HRP Template 2 V3/130ul 20181022 end 220uIA4	34	1	N	2/1/2022 1:09:38 PM	2/1/2022 3:32:42 PM

Status  
[Finished]

Reagent Name	Time (hh:mm:ss)	Temperature (C°)	Volume (ul)	Lot Number	Catalog Number	Expiry Date
DS1	0:05:00	65	240	220131	1	2023-07
DS2-50	0:04:30	58	200	220131	2	2023-07
AR2, low pH	0:32:00	101	370	220131	3	2023-07
System Fluid	0:04:20	33	220	N/A	N/A	2022-02
CD20	0:30:00	25	130	220131	4	2023-07
System Fluid	0:00:10	25	220	N/A	N/A	2022-02
Mouse HRP	0:20:00	25	130	220131	5	2023-07
System Fluid	0:04:20	35	240	N/A	N/A	2022-02
System Fluid	0:04:20	35	240	N/A	N/A	2022-02
DAB	0:08:40	37	200	N/A	On Rack Mixing	2022-02
System Fluid	0:00:10	25	240	N/A	N/A	2022-02

Ctrl: 0, Unknown; 1, Normal slide; 2, Positive control slide; 3, Negative control slide.

Figure 139

The first line displays the date and time that the report was generated.

The first table displays the Instrument Serial Number, Operator name, unique Run ID, and unique Slide ID.

*Note: The slide may be associated with 2 or more unique Run IDs if its run process was interrupted by the continuous loading feature.*

Instrument	Operator	Run ID	Slide ID
PC21085	Distributor	us5m26nCGE200k_UMbY4zg	GmCnqX8qskOV34p8Xi7KAq

Figure 140

The second table displays the Patient ID, Case Number, Block ID, Specimen Type, Additional Information 1, and Additional Information 2.

Patient ID	Case Number	Block ID	Specimen	Additional Information 1	Additional Information 2
Patient A	123456	4A	Tissue X	Hospital F	test label

Figure 141

The third table displays the Protocol Name, Detection Type, Slide Position, Control Type(normal, positive or negative), LIS(yes/no), Start Time, and End Time.

*Note: The table will display 2 or more sets of Start/End times if the run process was interrupted by the continuous loading feature.*

Protocol Name	Detection	Position	Ctrl	LIS	Start	End
CD20	Ms HRP Template 2 V3/130ul 20181022 end 220ulA4	34	1	N	2/1/2022 1:09:39 PM	2/1/2022 3:32:42 PM

Figure 142

The fourth table displays the Run Status, logging any warnings/errors that occurred during the run and the final status [Finished].

*Note: The [Stopped] status indicates that the run process was interrupted by the continuous loading feature.*

Status
[Finished]

Figure 143

The fifth table displays a summary of the protocol steps performed (Reagent Name, Incubation Time and Temperature, Volume) and reagents used (Lot Number, Catalog Number, Expiration Date) on the slide.

*Note: System Fluid and manually assigned reagents will display an Expiry Date using the current month by default.*

Reagent Name	Time (hh:mm:ss)	Temperature (C°)	Volume (ul)	Lot Number	Catalog Number	Expiry Date
DS1	0:05:00	65	240	220131	1	2023-07
DS2-50	0:04:30	58	200	220131	2	2023-07
AR2, low pH	0:32:00	101	370	220131	3	2023-07
System Fluid	0:04:20	33	220	N/A	N/A	2022-02
CD20	0:30:00	25	130	220131	4	2023-07
System Fluid	0:00:10	25	220	N/A	N/A	2022-02
Mouse HRP	0:20:00	25	130	220131	5	2023-07
System Fluid	0:04:20	35	240	N/A	N/A	2022-02
System Fluid	0:04:20	35	240	N/A	N/A	2022-02
DAB	0:08:40	37	200	N/A	On Rack Mixing	2022-02
System Fluid	0:00:10	25	240	N/A	N/A	2022-02

Figure 144

## Reagent Usage in Run Report

The Reagent Usage in Run Report provides a detailed summary of the reagents used in an individual run. The reagents used in the run can be traced back to individual reagent vials by using the Tag ID, or by batch using the Lot Number.

The report can be generated from any Slide List.

The screenshot shows a window titled 'Reagent Report' with a toolbar at the top. The main content area displays the following information:

**Reagent Usage In Run Report**  
2/1/2022 5:23:57 PM

Instrument	Operator Name	Start Time	End Time	Status	Total Slides	Run UID
PC21085	Distributor	2/1/2022 1:09:20 PM	2/1/2022 3:32:42 PM	Finished		3 us5m26nCGE200k_UMbY4rg

Reagent Name	Tag ID	Test Contained	Test Used	Position	Catalog Number	Lot Number	Expiry	Vendor
DS1	E004020054BEA075	47	3	1 1		220131	2023-07	BIOCARE MEDICAL
DS2-50	E004020054945569	47	3	2 2		220131	2023-07	BIOCARE MEDICAL
AR2, low pH	E004020054BEAFBD	31	3	3 3		220131	2023-07	BIOCARE MEDICAL
CD20	E004020055269E47	58	2	6 4		220131	2023-07	BIOCARE MEDICAL
Universal Negative	E00402005491CC98	99	1	10 8		220131	2023-07	BIOCARE MEDICAL
Mouse HRP	E00402005491BDA9	97	3	5 5		220131	2023-07	BIOCARE MEDICAL
DAB Buffer	E004020054915B07	55	5	7 6		220131	2023-07	BIOCARE MEDICAL
DAB Chromogen	E00402005496D1DD	55	5	4 7		220131	2023-07	BIOCARE MEDICAL
DAB	FFFFFFFFFFFFFFFF	0	3	40 On Rack Mixing		N/A	2022-02	N/A

1 of 1

Figure 145

The first line displays the date and time the report was generated.

The first table displays the Instrument Serial Number, the Operator Name, the Start Time and End Time, the Run Status, the Total Slides, and the unique Run ID.

The second table displays a summary of all reagents used in the run (Reagent Name, Tag ID, Test Contained, Test Used, Position, Catalog Number, Lot Number, Expiration Date, Vendor Name).

## Reagent Usage Report

The Reagent Usage Report provides an overall summary of total reagents usage for a user-specified time period. This data may be useful for ordering and tracking reagent consumption. The report can be generated from any Run List.

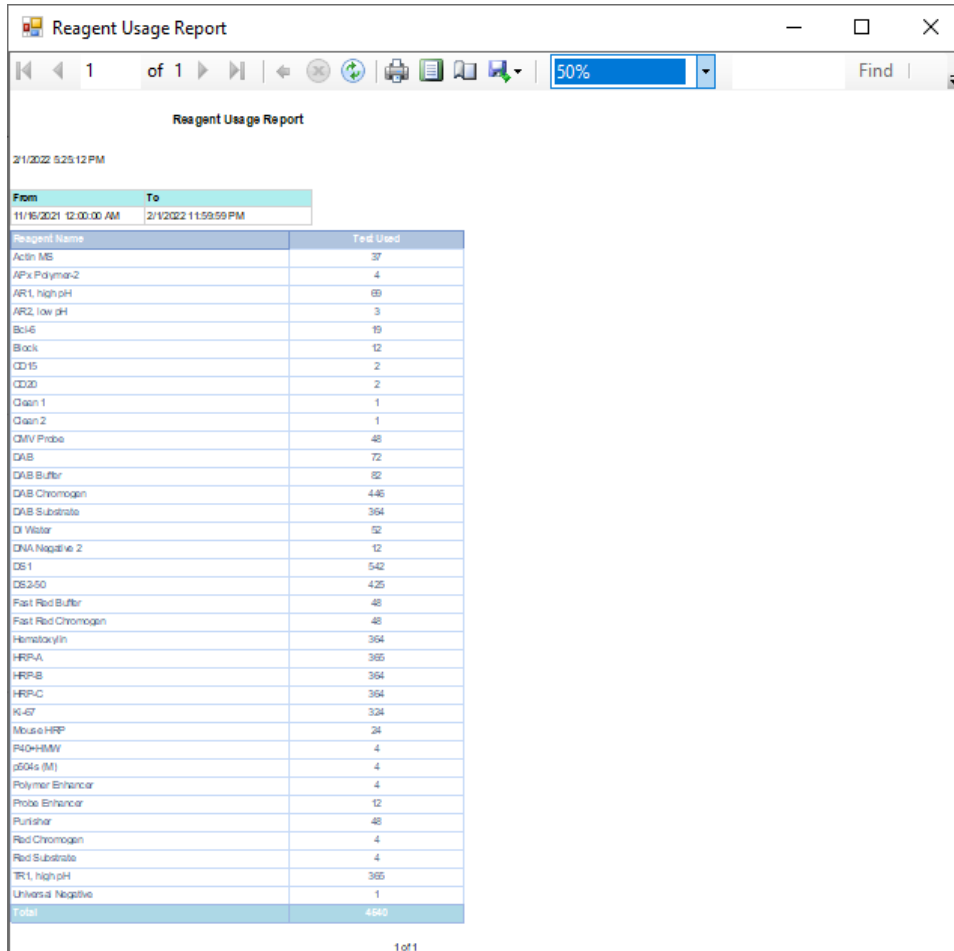

The screenshot shows a window titled "Reagent Usage Report" with a toolbar at the top containing navigation and search icons. Below the toolbar, the report title "Reagent Usage Report" is centered. The date and time "2/1/2022 5:25:12 PM" are displayed. A table with two columns, "From" and "To", shows the time period from "11/16/2021 12:00:00 AM" to "2/1/2022 11:59:59 PM". The main table lists reagent names and the number of tests used for each. The total number of tests used is 490.

Reagent Name	Test Used
Actin MS	37
APx Polymer-2	4
AR1, high pH	69
AR2, low pH	3
Bcl-6	19
Block	12
CD15	2
CD30	2
Clean 1	1
Clean 2	1
CMV Probe	48
DAB	72
DAB Buffer	82
DAB Chromogen	446
DAB Substrate	364
DI Water	52
DNA Negative 2	12
DS1	542
DS250	425
Fast Red Buffer	48
Fast Red Chromogen	48
Hematoxylin	364
HRP-A	365
HRP-B	364
HRP-C	364
K-47	324
Mouse HRP	24
R4D-HRMV	4
sDNA (M)	4
Polymer Enhancer	4
Probe Enhancer	12
Purisher	48
Red Chromogen	4
Red Substrate	4
RT1, high pH	365
Universal Negative	1
<b>Total</b>	<b>490</b>

Figure 146

The first line displays the date and time the report was generated.

The first table displays the user-specified time period used to generate the list.

*Note: The report can also be generated using a Run List for an individual slide.*

The second table displays a list of all reagents and the number of tests used for each. The last line of the table displays the total number of tests used in the user-specified time period.

## Slide Summary Report

The Slide Summary Report provides an overall summary of all slides in a-specified run. The report can be generated from any Run List.

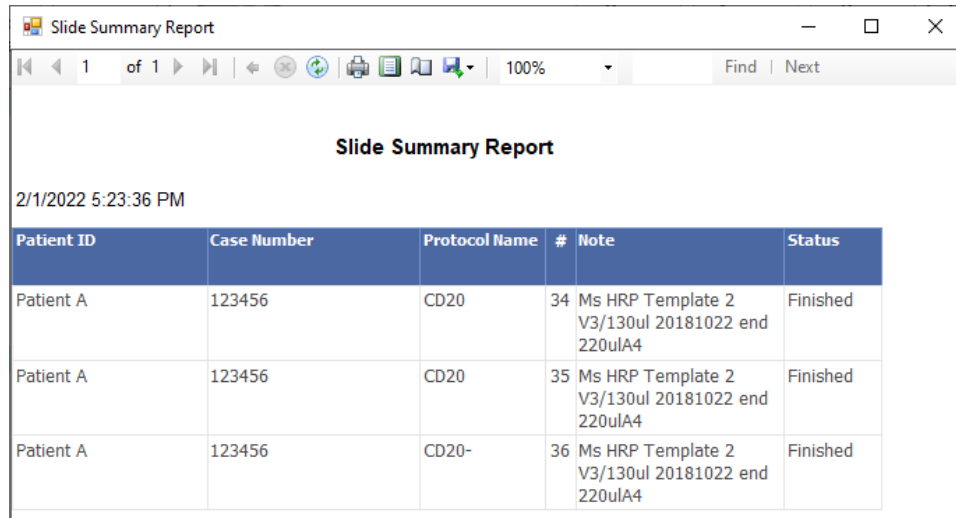

Slide Summary Report

2/1/2022 5:23:36 PM

Patient ID	Case Number	Protocol Name	#	Note	Status
Patient A	123456	CD20	34	Ms HRP Template 2 V3/130ul 20181022 end 220ulA4	Finished
Patient A	123456	CD20	35	Ms HRP Template 2 V3/130ul 20181022 end 220ulA4	Finished
Patient A	123456	CD20-	36	Ms HRP Template 2 V3/130ul 20181022 end 220ulA4	Finished

Figure 147

## 6.3. Print and Save a Report

The system can generate several types of reports. Navigate each report by using the page number, arrows and search box located in the toolbar.



To print a report, click the **Print** icon  in the toolbar and select a valid network printer.

 Do not select the barcode printer.

To save a report, click the **Export** icon  in the toolbar and select the application: Excel, PDF, or Word.

## 6.4. Backup Report Data

From the Main screen, click **“System Utilities”** and open the **Tools** tab.  
Click **“Backup Report Data”** to access the backup feature.

Select or enter a date in **Backup Report Data Before**. Click **“Backup”** to backup all data before the selected date.

Select the option to retain or remove the data after backup:

- A. **“Keep selected files after backup”**
- B. **“Remove selected files after backup”**

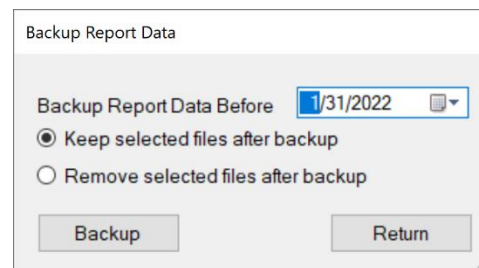

Figure 148

Select a folder location where the backup will be saved i.e.: local disk or external flash drive.  
Alternatively, the user may create a new folder location by clicking **“Make New Folder”**. Click **“OK”** to proceed.

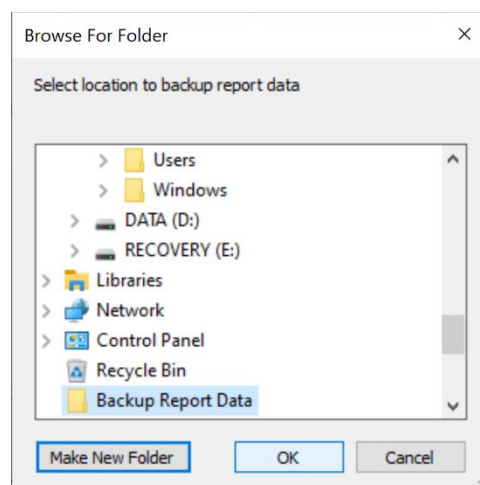

Figure 149

All report data files created before the selected date will be copied to a new folder named **“ReportDataBackup”** appended with the current date.

## Section 7. System Maintenance

The user should adhere to a routine preventative maintenance schedule to maximize the reliability and lifespan of the instrument. *Contact Customer Service for a supply of spares and consumable items.*

### 7.1. Daily Maintenance Recommendation

#### Modules

The modules should be cleaned routinely (recommended after every run) to prevent the buildup of salt and reagent residues.

1. Unload all slides from the system.
2. Remove the chambers from the modules and set aside in DI water for cleaning later.
3. Use a soft paper towel to wipe the surface of the heater and around the inner edge of the slip holder.
4. Insert the paper towel into the hinge to absorb any excess liquid remaining after the run.
5. Use a lint-free alcohol wipe to wipe away any remaining reagent residues.

#### Chamber

The chambers should be cleaned routinely (**WEEKLY** or after every five runs) to remove staining residues that could negatively affect staining quality.

Run the chamber cleaning protocol on all 36 module positions:

1. Load the provided ONCORE Pro Chamber Cleaning Kit onto the system.
  - a. Fill two of the provided empty vials labeled "DI Water" with distilled water.
  - b. Load a "Clean 1", "Clean 2", "Clean 3" and two full "DI Water" vials onto the reagent rack. A second "Clean 3" may be needed for sufficient volume.
  - c. Remove all reagent vial caps.
  - d. Click System Utilities>Tools>"Move Arm to Middle". Always move the robotic arm aside before adding or removing the reagent rack.
2. Load clean blank slides onto all 36 module positions.
  - a. Click "Load Unload Slides" to raise the lids.
  - b. Click "Slide Lids Down" to lower the lids after loading the slides.
3. Highlight all 36 module positions and click "Assign Protocols". Highlight the "Clean Chamber" protocol and click "Select".
4. Click "Scan Reagents".
5. Click "Start Staining Run". The run will take approx. 2.5 hours.
6. Once complete, remove all vials and discard the 2 "DI Water" vials and any other empty vials. Remove and discard all 36 slides.
7. Wipe chambers and clean with lint-free alcohol wipes. Wipe the edges of the chamber housing.
8. Click System Utilities>Tools>"Move Arm to Middle". Gently wipe probes tips and wash stations with alcohol wipes, removing any salt build up.

#### Tubing and Pumps

(If applicable) Inspect tubing and pump syringes for leakage or a severe buildup of salt. Contact Customer Service to schedule a maintenance visit, if needed.



## 7.2. Weekly Maintenance Recommendation

### Modules and Deck Plate

The modules and deckplate should be cleaned and inspected routinely to maintain proper function.

1. Use a damp paper towel to wipe away any salt deposits that have accumulated on the module surfaces.
2. The user may pipette distilled water and/or alcohol into the hinge slot to dissolve any crystallized salt deposits.
3. The user may use a small tool such as a paper clip to remove any debris or glass fragments that are obstructing the hinge slot and preventing the slides from inserting properly.
4. Use a soft paper towel to absorb any excess liquid that has accumulated in the grooves of the deckplate.
5. (Optional) Perform a module and heater function check. This should be performed after receiving a temperature/module malfunction warning. Refer to **Check for Module Malfunction** p. 50 for more information.

### Wash Station and Z1/Z2 Probes

The waste stations and probes should be cleaned routinely to prevent salt obstructions.

1. Use a lint-free alcohol wipe to clean any reagent residues and salt deposits that have accumulated on the surface of the wash stations and probes.
2. Click System Utilities>Tools>"Move Arm to Middle" to gain access to the wash station and probes.  
 **Take care not to bend the probes. Verify the alignment of the Z1 and Z2 probes if needed.**
3. Inspect the percolation holes on the wash station and clean with a cotton swab and alcohol if needed.

### Tubing and Pumps

The tubing and pumps should be primed with distilled water if the instrument is to be left idle for a prolonged time, such as on long weekends or holidays.

1. Push the quick disconnect release to detach the buffer container and remove it from the instrument.
2. Empty and rinse out the contents.
3. Fill the buffer container approximately 1/3 or more full with DI Water and re-connect to the tubing.
4. Click System Utilities>Tools>"Prime Z1 and Z2" to prime the pumps and tubing several times.
5. Detach the buffer container and empty the remaining contents.

## 7.3. Monthly Maintenance Recommendation

### Chambers

The chambers should be inspected routinely and replaced as needed (estimated after every 50 runs).

### Tubing

The tubing should be inspected and cleaned routinely (recommended after every 500 slides) to prevent buildup of reagent residues. An obstruction in the tubing line may cause inconsistent/negative staining results and premature wear on the pumps.

1. Ensure that the buffer container is filled and connected to the tubing.
2. Load the reagent rack with cleaning solutions for Z1 and Z2 in the designated positions.
3. Click System Utilities>Tools>"Tubing Clean" to initiate tubing clean. *Refer to **Clean Z1/Z2 Tubing**, p. 48 for more details.*



Clean tubing as frequently as needed. Visually inspect the tubing for buildup of wax deposits or DAB/Hematoxylin precipitate.

### Robotic Arm

The robotic arm should be inspected routinely to maintain proper function.

1. Click System Utilities>"SP1-Z1 Calibration" and "SP1-Z2 Calibration" to verify the alignment of the Z1 and Z2 probes.
2. Verify that the robotic arm is operating smoothly.
3. System calibration may be performed by a trained service technician if the probe becomes severely bent. Contact Customer Service for assistance.

### Computer

The C:/PathCom folder should be backed up routinely onto a flash drive/external device.

Please contact Technical Support for additional assistance.

## 7.4. Annual/Semi-Annual Maintenance

Annual/semi-annual maintenance on the whole system must be performed by a trained service technician. Contact Customer Service to schedule a maintenance visit.

A scheduled maintenance may consist of:

1. Inspection of 36 modules. Replacement of modules or parts as needed.
2. Module calibration and testing as needed. Replacement of module O-rings as needed.
3. Inspection of the robotic arm. Lubrication of the XYZ rails.
4. System calibration of the XYZ robotic arm as needed.
5. Inspection of all probes/tubing/hoses and replacement of parts as needed.
6. Inspection of pumps. Replacement or cleaning of syringes as needed.
7. Software and Firmware upgrade if applicable.
8. Running diagnostics on the system.
9. Backup and removal of logs and data files.

## Section 8. General Precautions

**Make sure the slides are placed securely on the module** – the slide should be pushed in against the spring and the spring should push the slide back under the slide clips.

**Place the reagent rack firmly in its seated position** before starting a run on the instrument.

**Remove caps from reagent vials** before starting a run on the instrument.

**Keep the door closed during operation.** The robotic arm will move unexpectedly during operation - stay clear. Do not impair the movement of the robotic arm in any way.

**Contact Customer Service prior to using reagents and solutions supplied by other vendors** on your Slide Stainer. Some solvents, acids, and other solutions may cause damage to the internal components of the Slide Stainer and affect your instrument's performance and warranty.

**Wear disposable gloves and protective lab wear when handling reagents.** Reagents are harmful and irritating to the eyes, respiratory system and skin. It may cause lung and stomach damage if ingested. SDS are available from your local sales representative or online at [biocare.net](http://biocare.net).

**Hazardous reagent wastes must be disposed of according to local, state and federal regulations.** Wear appropriate Personal Protective Equipment to prevent exposure.

**Do not multitask or run CD/DVD players on the computer while the instrument is in operation.** Multitasking is defined as running more than one software application at a time. This may lock up the instrument.

**Disable Windows Automatic Update and other background programs** while the instrument is in operation.

**Disable the Local/Wireless Internet Connection.** The system should not be connected to the Internet.

**Do not modify Windows Power options or install a screen saver.** This may cause the computer to power off unexpectedly while the instrument is in operation or may lock up the instrument.

**Do not install third party software or hardware products.** Installing third party products may lock up the instrument and may void the warranty.

**Do not make any hardware or software changes** before consulting Technical Support.

**Do not use a USB cable longer than 3 meters (10 feet).**

**Restart the computer if:**

- 1) **The USB is disconnected/reconnected.** Always connect the USB to the designated USB port.
- 2) The power supply to the instrument is powered on/off or disconnected.
- 3) The computer is put into Sleep Mode or Hibernation Mode.
- 4) The user encounters an unexpected error.

**Do not attempt to service the instrument** unless instructed to do so by Technical Support. Doing so will void the warranty.

**Do not relocate the instrument to another site within your facility** before contacting Customer Service for vital information that may affect your warranty.