

# ONCORE™ PRO

## Operating Manual



# Table of Contents

<b>Section 1. Introduction</b>	<b>7</b>
<b>Section 2. System Specifications</b>	<b>8</b>
2.1. Instrument Overview	8
2.2. Module Overview	11
2.3. Technical Specifications	12
2.4. Accessories Included with the Oncore Pro Slide Stainer	13
2.5. Staining Area Range	14
Slide Dimensions	14
Tissue Thickness and Slide Placement	14
<b>Section 3. Installation Requirements and Instructions</b>	<b>15</b>
3.1. Installation Requirements	15
3.2. Installation Instructions	15
Contacts for Assistance	16
<b>Section 4. Instructions for Use</b>	<b>17</b>
4.1. Starting Up the Slide Stainer	17
4.2. Preparing and Printing Labels	19
Add New Labels in the Barcode Editor	19
Print Labels in the Slide Label Editor	21
Move Slides to Printed Slides (for use with LIS only)	22
4.3. Loading Slides and Installing Chambers	22
Load/Unload Slides	22
Install/Remove Chambers	23
4.4. Assigning Protocols: Scan Slides and Manually Assign Protocols	24
4.5. Loading Reagents	26
4.6. Reagent Vialing Specifications	28
7mL Reagent Vial Specifications	28
15mL Reagent Vial Specifications	28
Instructions for Use	29
4.7. Refill Buffer and Empty Waste	29
Refill the Wash Buffer Bottle	29
Empty the Waste Containers	29
4.8. Reagent Check: Scan Reagents	31
4.9. Starting the Run	34
Gantt Chart	36
4.10. Auto Start	37
4.11. Completing a Run	37
Runtime Monitoring	38
End of Run	39
Aborting a Run	40
4.12. Continuous Loading	41
Stop the Current Run	41
Restart the Run	42
4.13. Shutting Down the Slide Stainer	44
<b>Section 5. System Utilities</b>	<b>45</b>
5.1. Tools	45
Prepare Slides with Baking Slides Function	46
Load a Saved Slide Map File	46
Verify the Calibration of SP1-Z1 or SP1-Z2	46
Verify the Calibration of the Barcode Reader	47

Clean Z1/Z2 Tubing .....	47
(Optional) Access the Tubing Clean Log .....	48
(Optional) Reset the Module/Chamber Usage Counter .....	48
Generate Reports .....	49
Move Robot XYZ Arm Aside .....	49
Perform System Initialization .....	49
Check for Module Malfunction .....	49
Flush Tubing with Prime Pump Z1 and Z2 Function .....	50
Prime Pump Z1 or Pump Z2 .....	50
Lock Door .....	50
Unlock Door .....	50
Backup Report Data .....	51
<b>5.2. Editors .....</b>	<b>51</b>
Editing Protocols in the Protocol Editor .....	52
Restoring Protocol Customizations in the Protocol Editor .....	54
Editing Protocols in the Protocol Editor: ISH/CISH/FISH .....	55
Viewing Special Protocols in the Protocol Editor .....	55
Changing the Protocol Template .....	56
Importing Protocols in the PR Manager .....	57
Assigning Negative Controls .....	59
Adding Reagents and Protocols in the Reagent Editor .....	60
Preparing RFID Reagent Tags with the RFID Tag Editor .....	62
Creating Custom Groups .....	64
Creating Custom Panels .....	65
<b>5.3. Security .....</b>	<b>66</b>
Change Password .....	66
User Administration .....	66
<b>5.4. Settings .....</b>	<b>67</b>
Baking Slide Settings .....	68
2D Barcode Format .....	68
Save All Customizations .....	70
Device Version .....	70
Baking Slides Option .....	70
Detect Waste Overflow Option .....	70
Run Without RFID Reader Option .....	70
Reagent Consumption Priority .....	70
Language .....	70
Tubing Clean Tracking Option .....	71
Module Tracking Option .....	71
<b>5.5. Network .....</b>	<b>72</b>
<b>5.6. LIS/LIMS .....</b>	<b>74</b>
<b>Section 6. Reports .....</b>	<b>75</b>
<b>6.1. Generate a Report .....</b>	<b>75</b>
Slide Barcode .....	75
Patient Information .....	77
<b>6.2. Report Types .....</b>	<b>78</b>
Slide Report .....	78
Reagent Usage in Run Report .....	80
Reagent Usage Report .....	81
Slide Summary Report .....	82
Staining Runs .....	83
<b>6.3. Print and Save a Report .....</b>	<b>84</b>
<b>6.4. Backup Report Data .....</b>	<b>84</b>

<b>Section 7. System Maintenance .....</b>	<b>85</b>
7.1. Daily Maintenance Recommendation .....	85
Modules .....	85
Chamber .....	85
Tubing and Pumps .....	85
7.2. Weekly Maintenance Recommendation .....	86
Modules and Deck Plate .....	86
Wash Station and Z1/Z2 Probes .....	86
Tubing and Pumps .....	86
7.3. Monthly Maintenance Recommendation .....	87
Chambers .....	87
Tubing .....	87
Robotic Arm .....	87
Computer .....	87
7.4. Annual/Semi-Annual Maintenance .....	87
<b>Section 8. General Precautions .....</b>	<b>88</b>

## Oncore Pro Slide Stainer Information

**Oncore Pro Slide Stainer Model: ONCPRO0001**

**Software Version: 3.0**

**Computer Configuration:**

Laptop or Desktop Computer with Mouse

Instrument Communications Interface: USB 2.0

USB Cable has to be less than 3 meters (10 feet)

**The use of this instrument is fully licensed under U.S. Patent no. 5,839,091; U.S. Patent no. 7,476,543; U.S. Patent no. 7,635,453; and U.S. Patent no. 7,977,086 B2.**

## Oncore Pro Slide Stainer Software Product License

IMPORTANT: Please read the license carefully before using this Software. The right to use this Software is granted only if the Customer agrees to the terms of this license

HOWEVER, USE OF THIS SOFTWARE INDICATES YOUR ACCEPTANCE OF THESE TERMS AND CONDITIONS.

In return for the payment of the applicable one time license fee included with the purchase price of the Oncore Pro Slide Stainer, BioCare grants the user a license to use one copy of the Software subject to the following terms and conditions. No title or ownership of the Software is conferred with this license.

1. The Software may be used on one Oncore Pro Slide Stainer.
2. The Software may not be copied.
3. The Software may not be disassembled, decompiled, decrypted or reverse engineered.
4. BioCare reserves the right to terminate this license upon breach. In the event of termination at BioCare's election, all copies of the Software must be returned to BioCare.
5. No title or ownership of the Software is conferred with this license.

## Safety

**Report any serious incidents related to this device to your local Oncore Pro representative and the state's competent authority.** Contact Customer Service if you have any questions or concern regarding safety.



### Protection from High Temperatures

The instrument is equipped with a safety interlock system so that the door remains locked during instrument operation. However, the heaters inside may reach high temperatures. Care must be exercised to make sure that the heaters have cooled down sufficiently before removing the slides.



### Protection from Moving Parts

The instrument is equipped with a safety interlock system so that the door remains locked during instrument operation. The interlock will automatically engage to restrict access to the inside of the instrument while it is the instrument is in operation. Never tamper with the safety interlock system.



### Use of Hazardous Reagents

Some reagents used on the instrument may be considered hazardous. Hazardous reagent wastes must be disposed of according to local, state and federal regulations. Wear appropriate Personal Protective Equipment to prevent exposure. It is the responsibility of the user to comply with the local, state and federal regulations.



### Maintenance

**Do not attempt to service the Oncore Pro Slide Stainer unless instructed to do so by Technical Support. Doing so will void the warranty. Removing the back panel may also electrical hazard.**

The instrument must be unplugged from the power source before the outer housing can be removed. The power supply is connected to 120/240V power source and the power cord must be disconnected from the AC power port before any maintenance work is started.

### Decontamination

Use bleach at 1:10 dilution to decontaminate the instrument. Do not use bleach with any other chemicals because it may react and create toxic fumes. Decontaminate in a well ventilated room.

# Section 1. Introduction

## **Intended Use of the Equipment**

The Oncore Pro Slide Stainer is a fully-automated slide processing system for staining paraffin-embedded and frozen tissue sections, cytopins, cell smears and fine needle aspirates. This universal system is designed to automate the manual staining methods routinely used in immunohistochemistry, in situ hybridization and related applications.

## **Quick Start-up**

The Oncore Pro Service Team installs and tests each system to ensure optimal performance.

The system is factory-installed with a set of standard protocols optimized for use with the Oncore Pro detection kits and its comprehensive line of ready-to-use primary antibodies and probes.

## **Flexible Programming**

The Oncore Pro Slide Stainer software implements user-customized protocols and slide-specific programming. The system provides intuitive programming routines, reagent and slide loading maps and a convenient run time display. Each staining run can process 1 to 36 microscope slides. Each slide can be programmed to run a different protocol.

## **Economic Use**

The Oncore Pro Slide Stainer maximizes efficiency by operating with small volumes of reagent and wash buffer, effectively reducing supply and waste disposal costs. The system provides the flexibility to optimize reagent volumes and wash steps.

## **Reagent RFID Tags**

Reagent RFID tags store programmable information such as reagent name, lot number and expiration date. The on-board RFID reader scans and identifies reagent vials to automatically determine if there are sufficient resources to complete a selected staining protocol.

## **Slide 2D Barcode Labels**

The Oncore Pro Slide Stainer software provides a simple user interface to generate and print 2D Barcode labels for slides. The on-board 2D barcode reader scans and identifies slides to automatically program a run and track slides. All printed labels are heat and chemical-resistant, allowing users to apply slide labels prior to starting the staining procedure.

## Section 2. System Specifications

The Oncore Pro Slide Stainer system employs a unique integration of hardware, software, and reagent chemistry to provide full automation of immunohistochemical staining methods. This section provides an overview of the instrument and details the technical specifications.

### 2.1. Instrument Overview

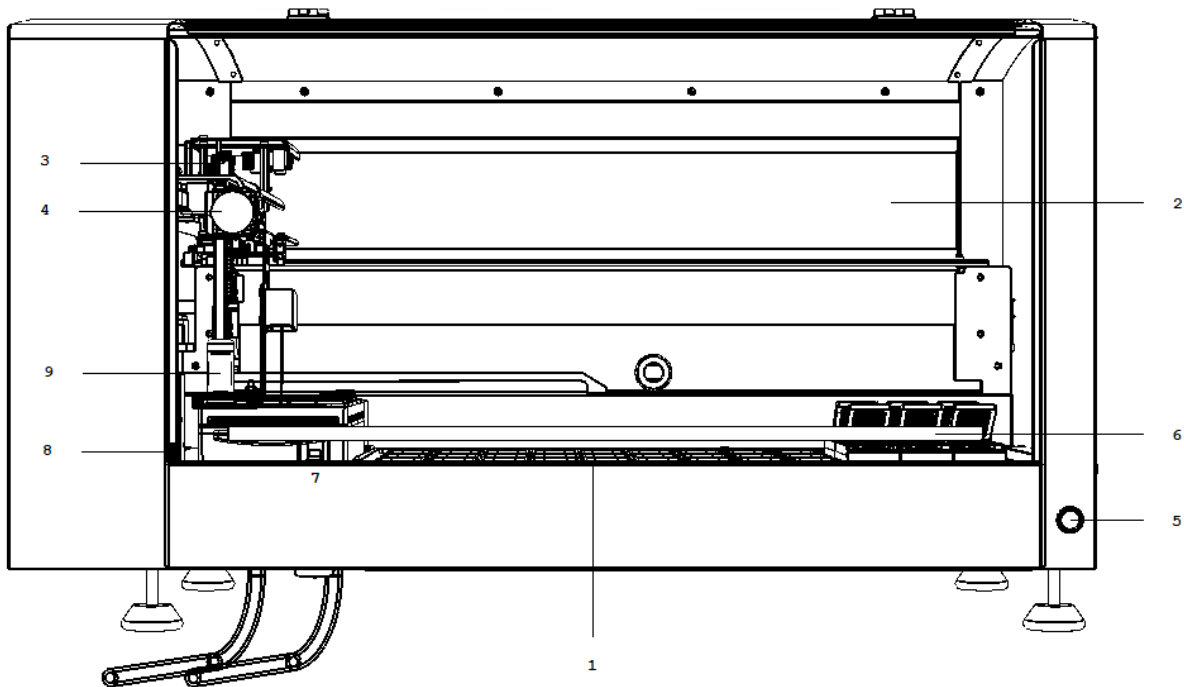

Figure 1

1. **Slide Deck** holds 36 modules, a reagent rack, and 2 probe wash stations.
2. **X axis mechanism** moves the robotic arm from left to right.
3. **Y axis mechanism** carries the Z head assembly and moves the arm from front to back
4. **Z head Assembly** consists of 2 independent Z axes (Z1 and Z2) situated on the Y arm.
5. **Power Button** turns the instrument on/off.
6. **Door controls** access to the instrument.
7. **Linear Solenoid** locks the door.
8. **Safety Interlock Switch** blocks unsafe access to the instrument while the robotic arm is in motion.
9. **Liquid Level Sensor (Z1 only)** detects the liquid level in the reagent vial and waste station during runtime. The system will issue a warning when a reagent vial has insufficient volume or when a waste station is overflowing.



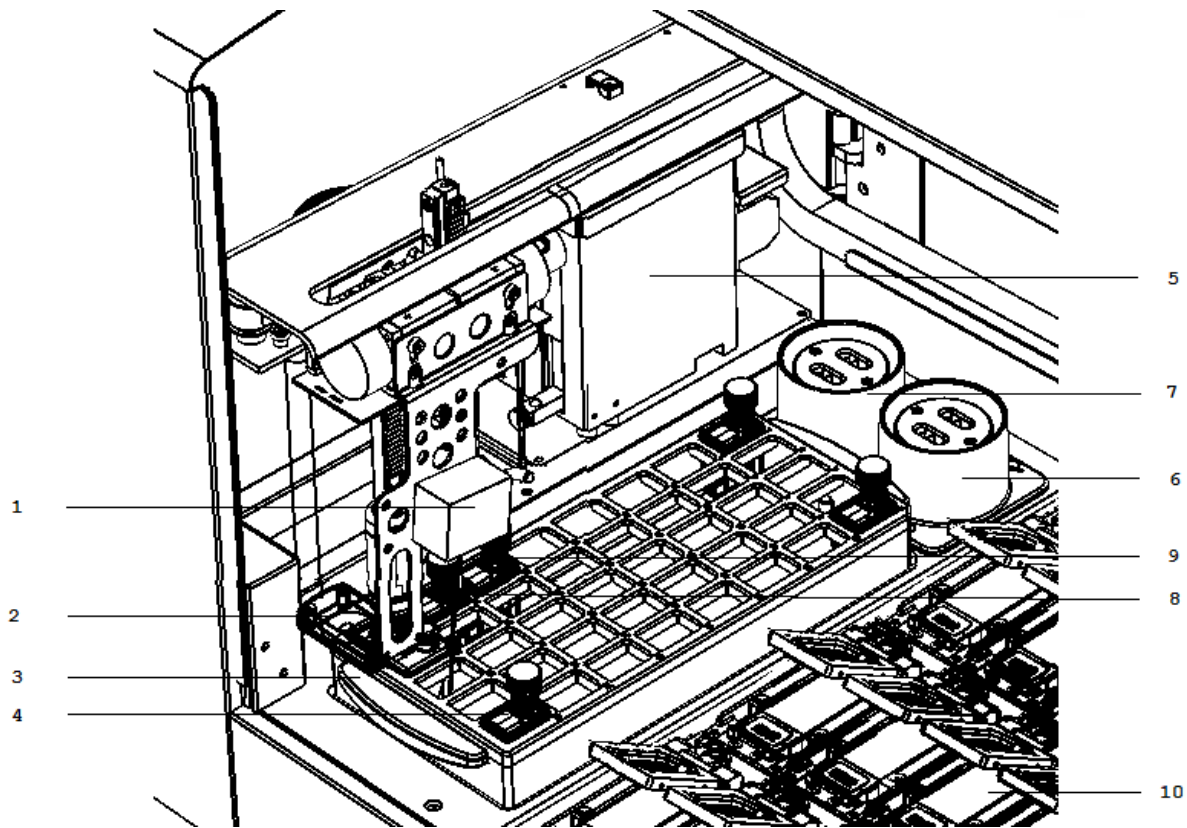

Figure 2

1. **2D Barcode Reader** scans the labelled slides on the slide deck to assign protocols for the staining run.
2. **RFID Reader** scans the RFID-tagged reagent vials to determine the reagents' positions on the rack and updates the reagent usage information to the RFID tags during the run.
3. **Reagent Rack** holds the reagent vials. There are 40 available reagent vials positions.
4. **Reagent Vials** holds the reagents. 15mL and 7mL size options.
5. **Pumps (Z1 and Z2)** draw and dispense buffer and reagents through the in-line tubing (max 5mL capacity)
6. **Wash/Waste Station** is an assembly located in the rear left corner of the instrument and is used as a cleaning station for the reagent probes. There is a purging position for the reagent waste and a percolating position for cleaning the outside of the probe each time a new reagent is used.
7. **Hazardous Wash/Waste Station** is a second probe wash station dedicated to hazardous reagents. Hazardous reagents will be separately dispensed into the hazardous waste station and will be collected in the Hazardous Waste Container.
8. **Z1 Probe** is a Teflon™-coated stainless steel probe that aspirates the reagents from the vials/in-line wash buffer and dispenses the reagents into the chambers.
9. **Z2 probe** is a Teflon™-coated stainless steel probe that extracts the reagent waste from the chambers and aspirates/dispenses reagent during on-board mixing.
10. **Module** is an assembly that holds 1 glass slide. 36 modules per instrument.

**Not pictured:**

11. **Tubing (Z1 and Z2)** connects the pumps with the probes to transfer buffer, reagents, and waste.

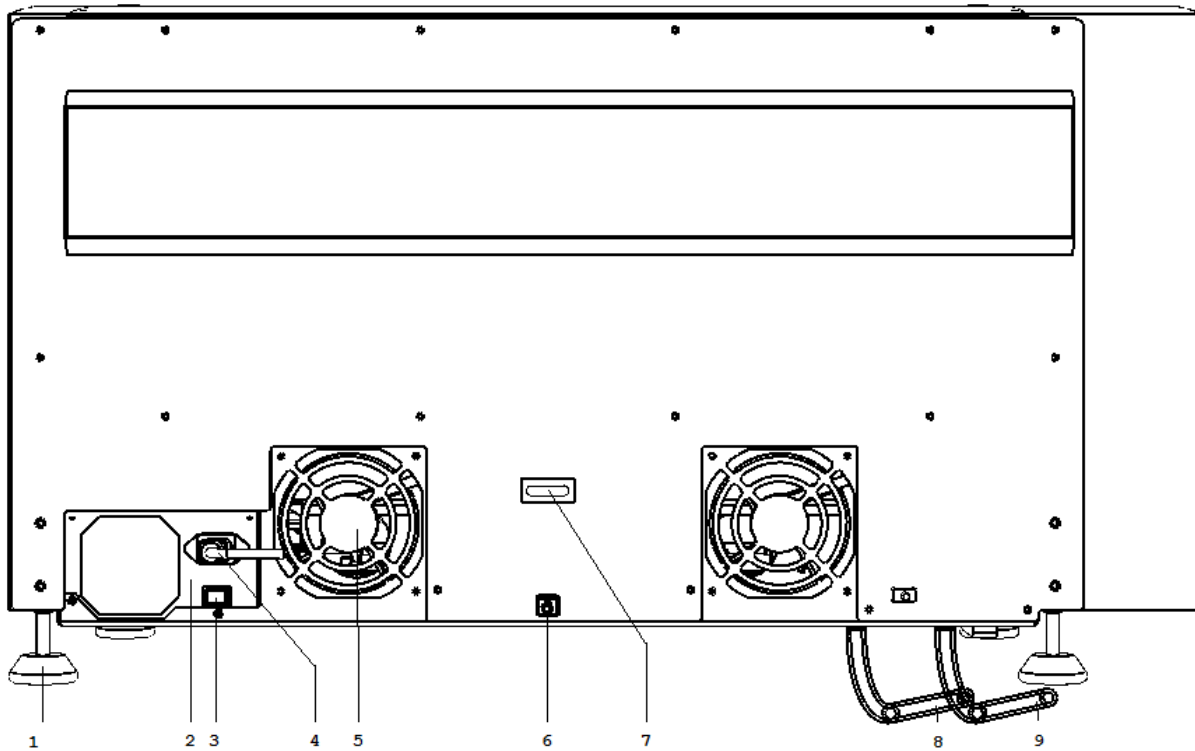

Figure 3

1. **Feet** adjusted to level the instrument on the work surface.
2. **Main Power Supply** connects to the wall outlet and provides power to the instrument.
3. **Power Supply Switch** turns the power supply on/off.
4. **AC Power Port** is the position to plug in the power cord.
5. **Fan** provides cooling to the instrument and its electrical components.
6. **USB Port** is the position to plug in the USB cable.
7. **U-Ring** is the position to attach an anti-theft chain to the computer.
8. **Waste Tubing (Blue)** connects the waste station to the waste container to transfer waste (gravity-fed).
9. **Hazardous Waste Tubing (Black)** connects the waste station to the hazardous waste container to transfer hazardous waste (gravity-fed).

## 2.2. Module Overview

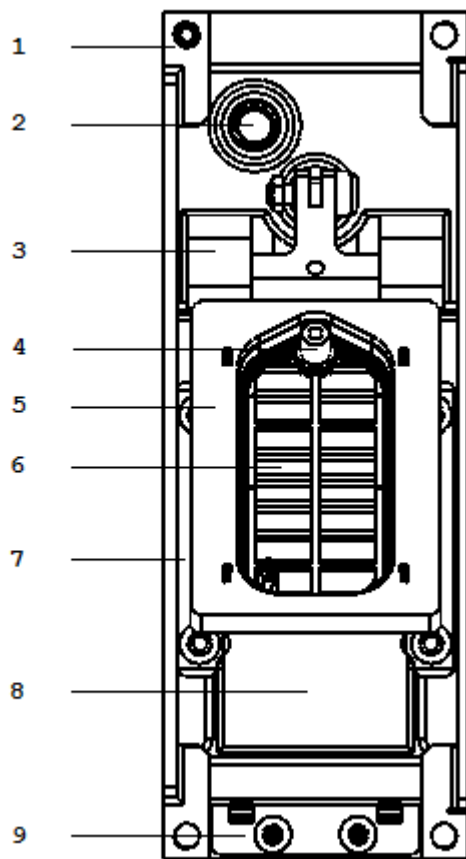

Figure 4

1. **Side Retainer Clips (2)** secure the module onto the instrument deck plate.
2. **LED Light** displays heater status green (inactive) or orange (active).
3. **Hinge** secures the slide at the back.
4. **Chamber Chimney** reagent dispensation/waste extraction point.
5. **Slip Holder** holds the chamber. Moves to controlled angles to facilitate incubation and reagent dispensation/waste extraction.
6. **Chamber** (consumable) holds reagent/buffer on the slide during the incubation and washes.
7. **Side Rails (2)** secure the slide on the left/right.
8. **Heater** maintains temperature during incubation.
9. **Slide Clip** secures the slide at the front.

**Not pictured:**

10. **Glass Slide** is a standard microscope slide to which specimen(s) are mounted for processing on the instrument. Standard slide dimensions are 25mm x 75mm x 1mm.

## 2.3. Technical Specifications

### Dimensions W x H x D

36.5in x 22in x 24in/93cm x 56cm x 61cm  
(with door closed)

36.5in x 36in x 24in/93cm x 91cm x 61cm  
(with door open)

### Electrical requirements

120V 110/120V ( $\pm 10\%$ ) 60Hz ( $\pm 2\text{Hz}$ ) 850 watts  
220V 220/240V ( $\pm 10\%$ ) 50Hz ( $\pm 2\text{Hz}$ ) 850 watts  
Mains Connection: IEC320

### Slide capacity

1 - 36 glass slides

### Heating capacity

Room temperature to 103°C. Maximum 110°C.

### Reagent dispense volumes

130uL standard test volume  
(65 minimum-400  $\mu\text{L}$  maximum)

### Computer controller requirements

*BioCare reserves the right to change the computer controller specifications at any time.*

Intel Core i5-2410M CPU 2.3GHz  
4GB RAM  
500GB Hard drive  
4 USB 2.0 communication ports

### Computer/Monitor

Laptop or Desktop Computer

### Printer

Zebra TLP 3844-Z, Zebra GX430t or Zebra ZD620t

### Surge Protector

120/240 VAC, 15 Amps, 50/60 Hz

### LIS Connectivity

Compatible with SQL Database and HL7 messaging standards.

### Operating Logic

Designed to calculate the most time-efficient sequence of steps to complete a programmed staining run.

### Protocol Logic

Protocols are generated from a common protocol template optimized for each detection system. End-users have the limited ability to customize key protocol steps. Advanced users have full flexibility to add/remove and customize each step in the protocol template and to generate special protocols.

### Weight

125lb (57kg)

### Normal operating temperature

18°C-26°C (64°F-79°F)

### Reagent capacity

40 different reagents (15 mL/7mL reagent vial)

### Waste Separation

1 hazardous waste, 1 non-hazardous waste

### Reagent probe volume capacity

20  $\mu\text{L}$  minimum-4500 $\mu\text{L}$  maximum

### Operating System

Windows 7, 10

## 2.4. Accessories Included with the Oncore Pro Slide Stainer

**Reagent Rack** Two removable reagent racks. Each reagent rack holds a maximum of 40 reagent vials.

**Removable Vial Holder** Installed on the reagent rack for programming RFID-tagged reagent vials.

**Buffer Container** 2L plastic bottle with quick disconnect fittings. Stores the in-line wash buffer.

**Waste Container** Set of two 4L plastic bottles with cap. Stores the reagent waste generated during the run.

**Label Printer** 2D barcode printer, thermal-transfer.

**Labels** Size 19.05mm (*0.75in*) x 25.4mm (*1in*), 1000 labels/roll.

**Ribbon** Media ribbon for the printer.

**USB Cable** Connects the instrument and computer.

**Power Cord, Instrument**

**Computer** Pre-configured for use with instrument.

**Computer Mouse**

**Lint-Free Alcohol Wipes**

**Chamber** Set of 36 pre-installed on the modules.

## 2.5. Staining Area Range

To ensure staining quality and reliability, slides should be prepared following the guidelines of the Oncore Pro system.

### Slide Dimensions

Standard slide dimensions are 25mm x 75mm x 1mm

#### Material Glass, ISO 8037/1

	Dimensions (mm)
Width	25–26.0 mm (0.98–1.02 in)
Length	74.75–75.5 mm (2.94–2.97 in)
Thickness	0.95–1.1 mm (0.038–0.043 in)

 Note: Use of non-standard slides may affect staining area and staining quality.

### Tissue Thickness and Slide Placement

The recommended tissue thickness is 2-5 microns.

The circled area is the recommended tissue placement area.

The yellow highlighted region is the staining area range. This range may be expanded to the blue highlighted regions; however, staining results may not be ideal in these areas.

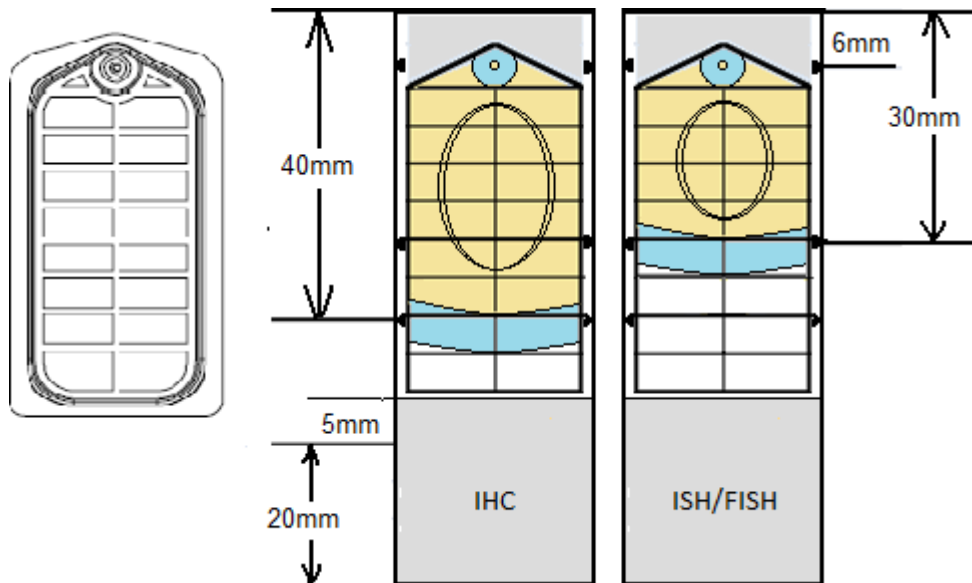

Figure 5

The IHC staining area extends to the 40 mm line on the slide.

The ISH staining area extends to the 30 mm line on the slide.

## Section 3. Installation Requirements and Instructions

This section provides an overview of the installation of the Oncore Pro Slide Stainer to be performed by the field service engineer. The following requirements should be met to ensure proper instrument function.

### 3.1. Installation Requirements

**Location** Place the system in an area where it is easy to operate and easy to connect to the instrument.

**Surface** Prior to unpacking, ensure that the work area for the instrument is a solid, level surface that can safely support the weight of the system.

**Size** Minimum dimensions for the work area are 36.5 inch (93 cm) width x 36 inch (91 cm) height x 24 inch (61 cm) depth clearance.

**Environment** The work area must be in an environment with an ambient temperature between 18°C-26°C (64°F-79°F). The area must be properly ventilated with a maximum relative humidity of 80% for temperatures up to 31°C; Pollution Degree II or less. The equipment will produce less than 85 decibels at peak operation.

**Power source** The instrument and computer must be connected to a 120V/240 15A supply with grounding (3 prong). It is recommended to use a dedicated power source to prevent interference from other instruments or equipment. It is also recommended to use a UPS (uninterruptible power supply) with minimum 1500VA. This will help to prevent unexpected system failures due to an unstable power grid system or in the event of a temporary power outage.

### 3.2. Installation Instructions

**Unpacking** The system is packaged in a wooden crate mounted on a pallet. Unlatch all fasteners and remove the lid on top of the crate first. Remove the computer, accessories box and label printer from the shelf inside the crate. Remove the shelf and the sides of the crate.

**Installation** Requires 2 people. Each person should pick up one end of the instrument and carefully lift it out of the crate. Carefully move the instrument to the operating area and place it on the bench. Level the instrument surface using a bubble level. Remove all packing material and the packaging securing the robotic arm. Verify that all axes can move freely before operating the instrument. Unpack and install the computer and accessories.

**Hooking up** Connect the USB cable from the designated port on the computer to the back of the instrument.



Do not plug and unplug the USB cable while the PC or Instrument is on.

\*\*\*Always turn off the instrument and PC before plugging and unplugging the USB cable.

Connect the Computer to the power source or UPS. Follow the instructions on the UPS, as some may require powering up for several hours to charge the internal battery. Using a standard IEC320 compatible power cord, connect the AC power port at the rear of the instrument to the power source or UPS.

Cut the waste tubing to size and route to the waste bottles on the floor. The ideal configuration is straight down to the waste bottle in order to minimize the chance of overflow and waste buildup.



**Avoid immersing the waste tubing in the waste bottle or flattening and kinking the tubing as this may disrupt the gravity fed drainage and result in waste overflow.**

**Starting up** Turn on the instrument and computer.

Power on the power supply switch on the back of the instrument.

Power on the Slide Stainer by pushing on the power button at the front of the instrument.



Log in to the computer with the default User Name: *PathCom* and Password: *67471*

*Note: The user may change the computer user name and password after initial log in.*

Disable the Wi-Fi radio and local internet connection (if applicable).

This feature may cause unexpected crashes during instrument operation.

 **The internet access should only be enabled for a remote support session, email communication or web conference call. Disable the internet access while the instrument is in operation to prevent unexpected crashes.**

Disable automatic time synchronization.

This feature may cause unexpected crashes during instrument operation.

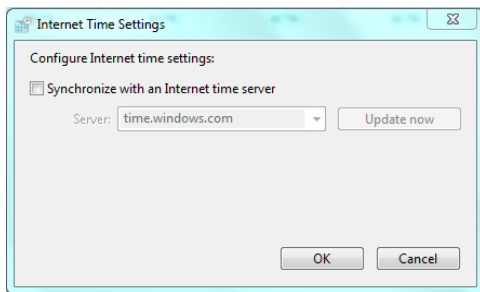

Figure 6

For Windows 7 systems: Configure Internet Time Settings within Windows Date and Time.

Uncheck the box, Synchronize with an Internet time server.

For Windows 10 systems: Configure Time & Language settings within Windows Settings.

Toggle Off the Date and time options as shown.

Set time automatically



Set time zone automatically



Figure 7

Load the ribbon and media on the barcode label printer according to the manufacturer's instructions.

Connect the printer to the designated port on the computer and switch the power on.

The printer driver will automatically install within a few minutes.

Calibrate the media if needed using the Zebra Setup Utilities.

The on-site field service engineer will perform the necessary system checks on robot, modules, and pumps.

### Contacts for Assistance

**Customer Service: 925-603-8000**

**Technical Support: 800-542-2002**

### Replacement of Consumable Materials

Replacements for all consumable materials can be obtained from:

**Website: [www. biocare.net](http://www.biocare.net)**



## Section 4. Instructions for Use

This section provides the instructions for daily routine operation of the Oncore Pro Slide Stainer. Please check all **Requirements** p.7 before beginning instrument operation.

### 4.1. Starting Up the Slide Stainer

Turn on the Slide Stainer using the power button and then turn on the computer.

*Note: It is important to follow this exact power on sequence.*

Double-click the shortcut for the **Oncore Pro Slide Stainer UI**  to access the login screen. Select “Yes” when prompted by Windows User Account Control to grant access permissions.

Login to the main user interface.

**Default User ID:** *Supervisor*

**Password:** *Supervisor*

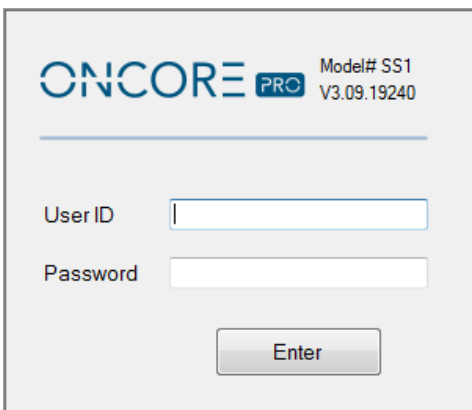

The login screen displays the ONCORE PRO logo and the model and version information: Model# SS1 V3.09.19240. Below this, there are two input fields: 'User ID' and 'Password'. An 'Enter' button is located below the password field.

Figure 8

Refer to **Security**, p. 66, for information on managing User IDs and Passwords.

Close the door of the Slide Stainer and click “**Enter**” to access the Main screen and begin system initialization.

The system will take a few minutes to verify all connections between the instrument and the computer, and then home the robotic arm, modules, and pumps.

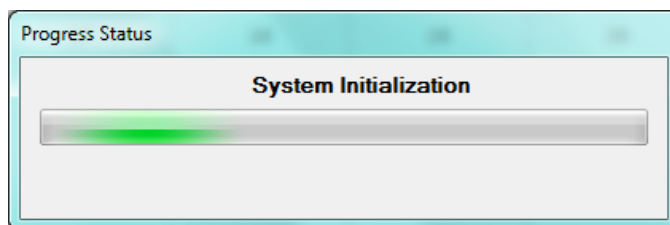

Figure 9

*Tip: If the system fails to start or is stopped/interrupted while performing a task, re-initialize the system and try again. Refer to **Perform System Initialization**, p.49, for more information.*

An interactive slide map corresponding to the 36 slide positions is displayed on the Main screen, displaying the status of the modules.

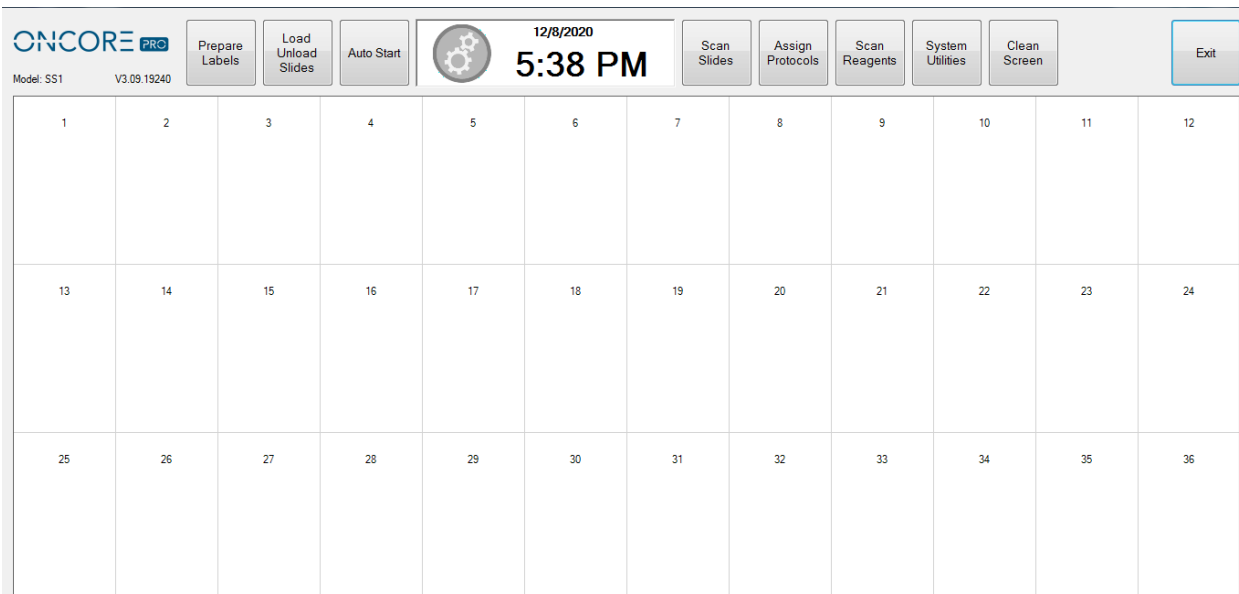

Figure 10

All routine functions are readily accessed from the **Main** screen.

To perform a typical run, click:

**Prepare Labels** to print labels for slides. Each label is printed with a 2D barcode required to identify the slide.

**Load/Unload Slides** to lift and lower lids for inserting and removing slides.

**Auto Start** to automatically start the run after loading the labeled slides and tagged reagents.

**Scan Slides** to scan the barcode labels on the slides.

**Assign Protocols** to manually assign a protocol to a slide.

**Scan Reagents** to scan the RFID tags on the reagent vials.

**System Utilities** to access additional features and utility functions.

**Clean Screen** to clear the slide map.

**Exit** to close the application.

## 4.2. Preparing and Printing Labels

From the Main screen, click “**Prepare Labels**” to open the **Slide Label Editor**:

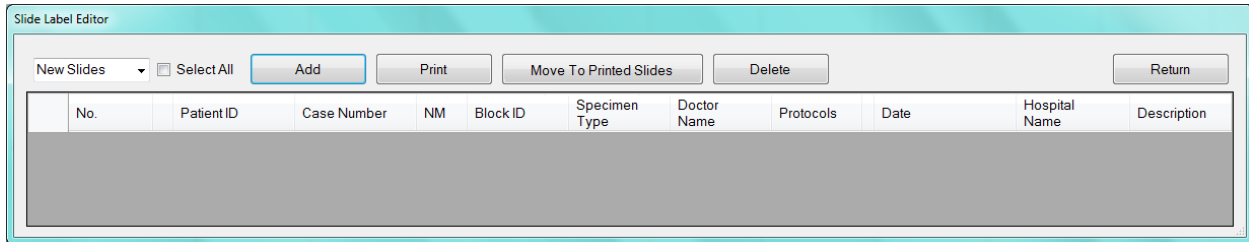
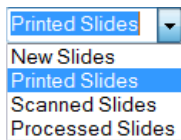

Figure 11

Labels available for printing are listed on the screen under **New Slides**.



- A. Select **New Slides** to create or view new labels.
- B. Select **Printed Slides** to review or reprint a label.
- C. Select **Scanned Slides** to review labels that have already been scanned.
- D. Select **Processed Slides** to review labels that have already been processed.

### Add New Labels in the Barcode Editor

Labels must be prepared in the Barcode Editor and added to the Slide Label Editor before they can be printed.

To add new labels, click “Add” to open the Barcode Editor.

Enter the **Patient ID**, **Case Number**, and other required label information\* into the designated fields.

**⚠ Note:** caret ^ and tilde ~ characters are not permitted in the entry fields.

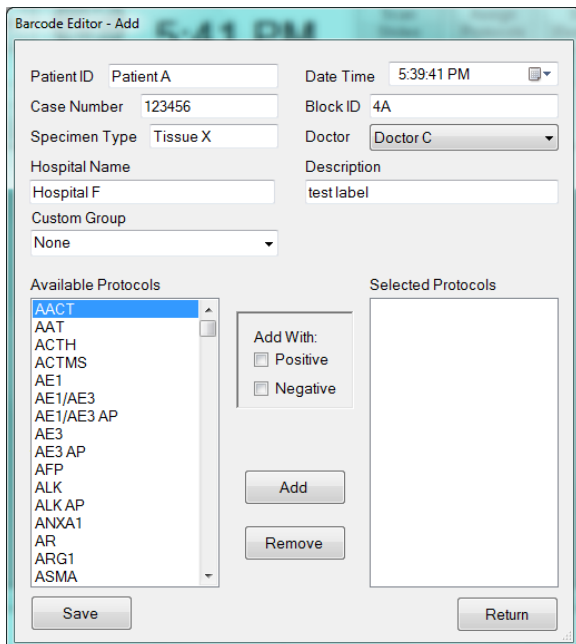

Figure 12

(Optional) Select the **Date Time** of the label.

(Optional) Select the name of the **Doctor** from the dropdown list. *To add new names to the list, refer to 2D Barcode Format p. 68.*

(Optional)\* To print the “Block ID” field to the slide label, the user must change the default label format. Select “Container Identifier” from the drop-down list in the desired field of the Label Formatter.

**Note:** The information entered may not be printable due to the size constraints of the label. Use abbreviations as needed or select a different label format. Protocol Name, Patient ID, Date, Case Number, Hospital Name and Description are printed on the label by default. *To change this setting, refer to 2D Barcode Format p.68.*

Next, add protocols to the list of **Selected Protocols**:

**To add protocols to the Selected Protocols,** select protocol(s) from the list of Available Protocols and click **“Add”**.  
*Tip: The user may search the list of protocols by typing the first few letters of the protocol name. Click **“Save”** to generate new labels for each protocol in the list of Selected Protocols.*

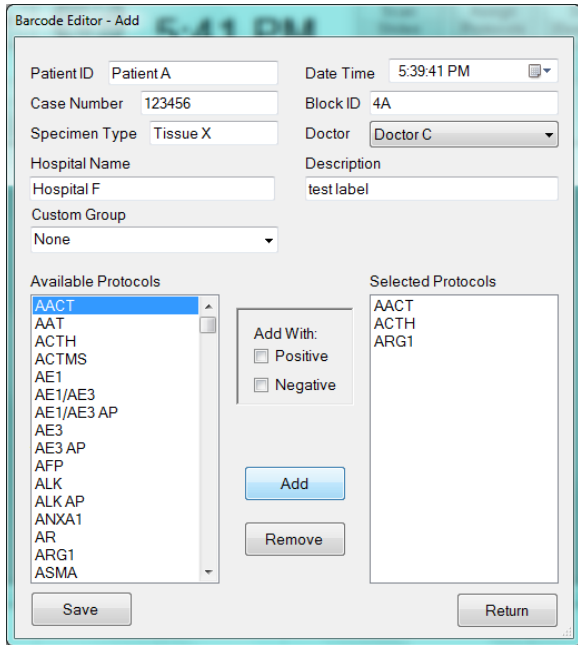

Figure 14

Alternatively, the user may use a customized sublist of available protocols by selecting a custom group from the **Custom Group** dropdown list.

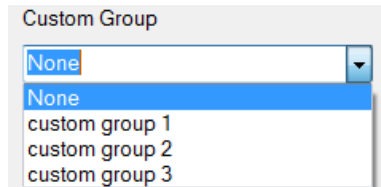

Figure 13

Refer to **Creating Custom Groups**, p. 63, for more information on creating custom groups.

**To remove protocols from the list of Selected Protocols,** select protocol(s) from the list and click **“Remove”**.

**(Optional) To add a positive and/or negative control to the Selected Protocols,** select the protocol and check the boxes **Add With: Positive** and/or **Negative**, and click **“Add”**. Click **“Save”** to generate new labels.

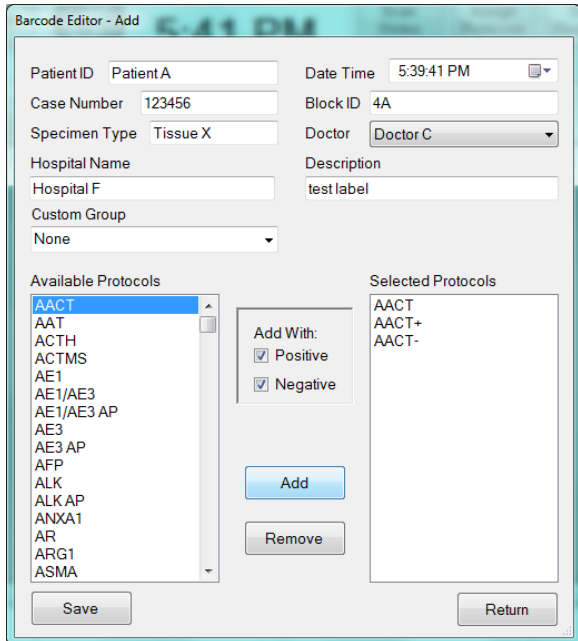

Figure 16

Refer to **Assigning Negative Controls**, p. 59, for more information on assigning negative controls to protocols.

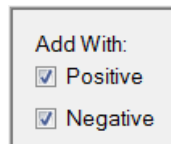

Figure 15

**(Optional) To add an entire panel of protocols to the Selected Protocols**, select the custom panel from the list of **Available Panels** and click **“Add”**. All protocols assigned to the panel (including positive and negative controls) will be added. Click **“Save”** to generate new labels.

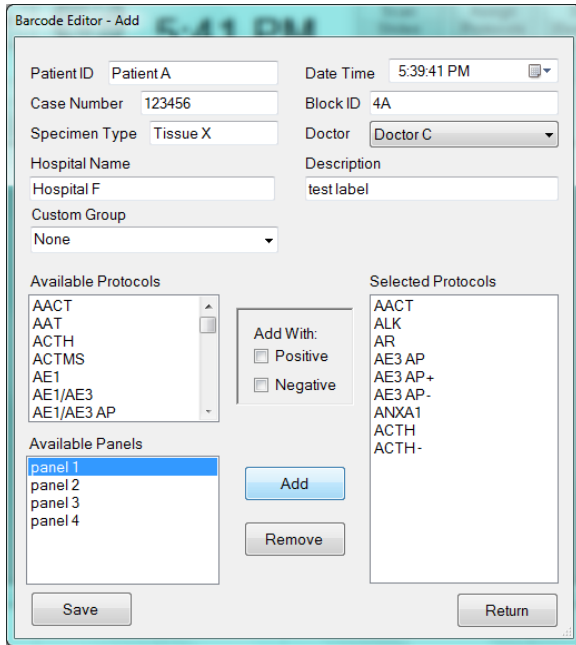

Figure 17

The user must first create a custom panel before the Available Panels field is made visible in Barcode Editor.

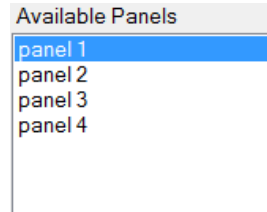

Figure 18

Refer to **Creating Custom Panels**, p. 64, for more information on creating Panels.

After saving the current labels, the user may continue preparing labels for the next case.

Click **“Return”** to close the Barcode Editor. By default, the input patient information is retained in the entry fields for the next set of labels. *To change this setting, refer to 2D Barcode Format p. 68.*

### Print Labels in the Slide Label Editor

All unprinted label entries are listed under New Slides in the Slide Label Editors. This list is automatically sorted by Patient ID; however, the user may sort the list by the column headers i.e.: Label No., Case Number, Block ID etc.

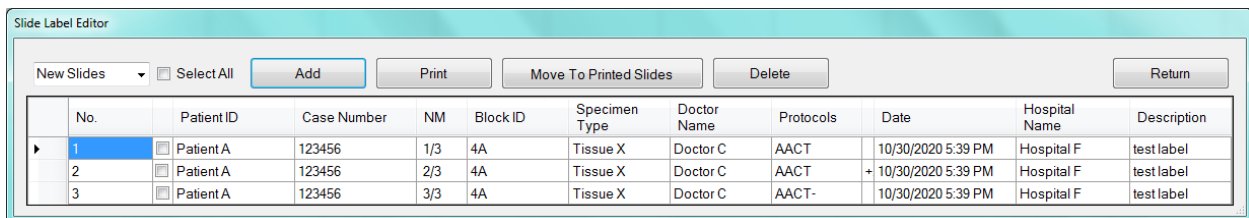

Figure 19

**To print labels from the Slide Label Editor**, select the label(s) or **“Select All”** using the checkbox, and click **“Print”**.

*Note: Label entries are automatically removed from the system after 30 days from the date assigned on the label.*

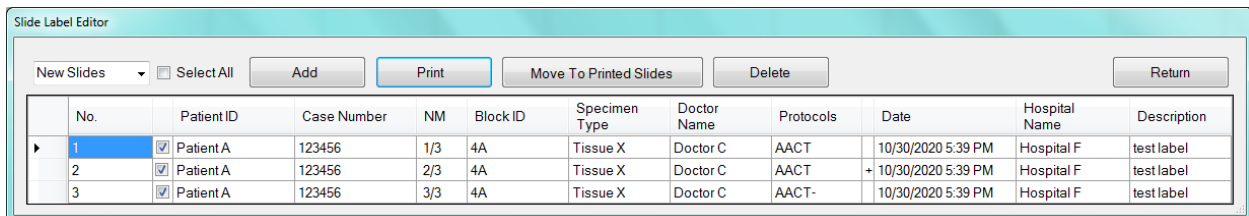

Figure 20

**To delete a label from the Slide Label Editor**, select the checkbox and click “Delete”.

*Note: Once the slide label(s) have been printed, slide processing is initiated and the slide information will be distributed to all Oncore Pro systems on the Network. The label entry can no longer be deleted.*

*Refer to 2D Barcode Format, p. 68, for information on adjusting printer settings and label format.*

### **Move Slides to Printed Slides (for use with LIS only)**

The Oncore Pro can be configured to recognize slide labels generated from an external source when integrated with an LIS system.

The LIS system sends the processing order to the Oncore Pro system. The ordered slides will appear under **New Slides** in the **Slide Label Editor**. The user has the option to 1) print the slide label(s) to initiate processing, or 2) directly move slide label(s) to **Printed Slides** to initiate slide processing without printing, or 3) delete the slide labels to cancel the order.

To manually move pre-printed labels to **Printed Slides** (without printing), select the label(s) using the checkbox and click “**Move To Printed Slides**”.

*Note: The 2D Barcode reader must be configured to recognize labels of different formats. Please contact Technical Support for more information.*

## 4.3. Loading Slides and Installing Chambers

From the Main screen, click “**Load Unload Slides**” to raise all module lids.

Peel the labels from the label roll and affix them to the frosted side of the slide.

Slides are loaded individually onto each module.

*For slides that must be baked prior to staining, refer to **Prepare Slides with Baking Slides Function** p. 46.*

*Refer to **Staining Area Range**, p. 28, for more information on tissue location recommendations for slides.*

### **Load/Unload Slides**

Verify that the heating plate and module surfaces are clean and dry before loading a new slide.

**To load a slide onto a module**, insert the slide into the hinge slot and then lower it onto the heating plate until it locks in place under the front clip. If needed, adjust the slide so that it is centered over the heating plate.

Click “**Slide Lids Down**” to lower all module lids.

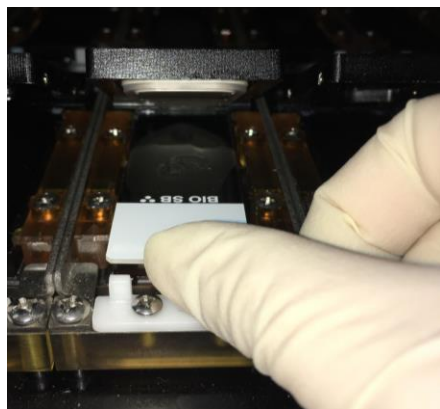

Figure 21

**To unload the slide from a module**, push the slide against the hinge slot until it is released from under the front clip. Carefully lift the slide out, keeping it horizontal to prevent excess buffer from spilling onto the module surfaces.

*Tip1: If the slide is too difficult to insert, clean the hinge to remove any salt or debris.*

*Tip2: The hinge contains springs to accommodate minor differences in slide length. However, if the slide is too long, the front clip can be adjusted by loosening the two screws with a small screwdriver.*

Transfer the slide to a slide rack and rinse it with distilled water before post treatment. Dry the hinge slot and module surfaces with an absorbent paper towel.

### Install/Remove Chambers

Chambers are installed individually onto each module. They should be removed from the module for routine cleaning and inspection to maintain optimal staining quality. Refer to *Chamber Cleaning Recommendations, p. 85, Chamber* for more information.

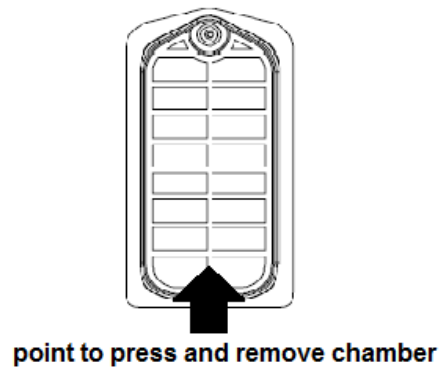
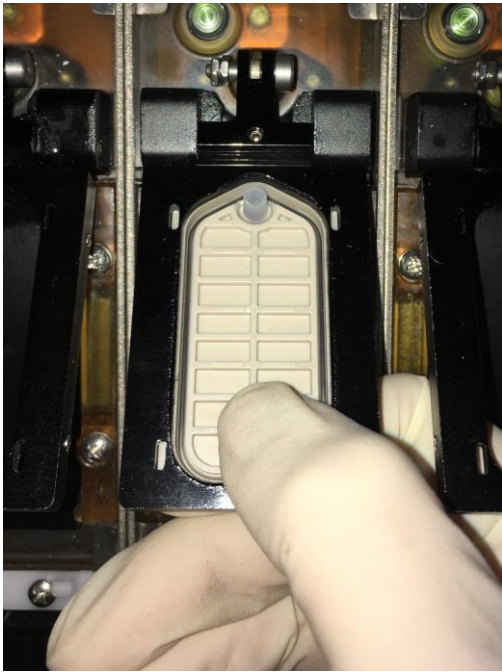

Figure 22

**To install the chamber**, slide the chamber into the recess under the module lid and push up on the chamber until it locks into place. Verify that all 4 corners of the chamber sit flat in place.

*Tip: Push up on the underside of the chamber surface to verify the integrity of the chamber gasket. If the chamber gasket is loose or damaged, it is time to replace the chamber.*

**To remove the chamber**, gently push down on the chamber to unlock it from the module lid. Transfer the chamber to a container for cleaning.

*Tip: After completing a staining run, gently wipe the chamber surfaces with a lint-free alcohol wipe to remove any staining residues/debris that may adhere to the chamber.*

## 4.4. Assigning Protocols: Scan Slides and Manually Assign Protocols

To automatically assign protocols by scanning labeled slides, close the door and click “Scan Slides” on the Main screen. The system will automatically scan all 36 slide positions and assign the protocol(s) of labeled slides to the appropriate position on the slide map.

*Tip: Click + drag on the slide map to select specific slide positions to scan.*

*Refer to **Editing Protocols**, p. 52, and **Change Protocol Template**, p. 56, for more information on generating protocols.*

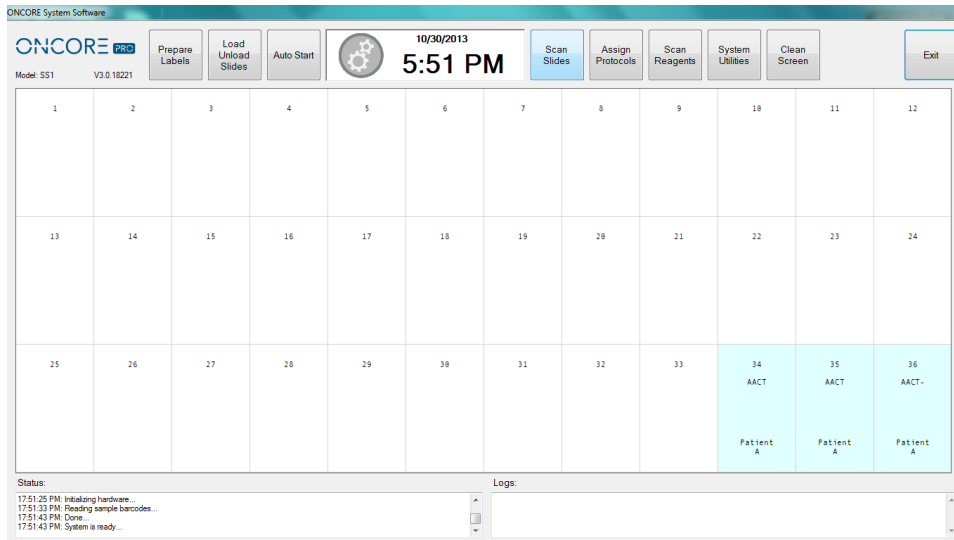

Figure 23

To manually assign protocols to unlabeled slides, click + drag on the slide map to select the slide position(s). The slide position(s) will be highlighted and display “????????”:

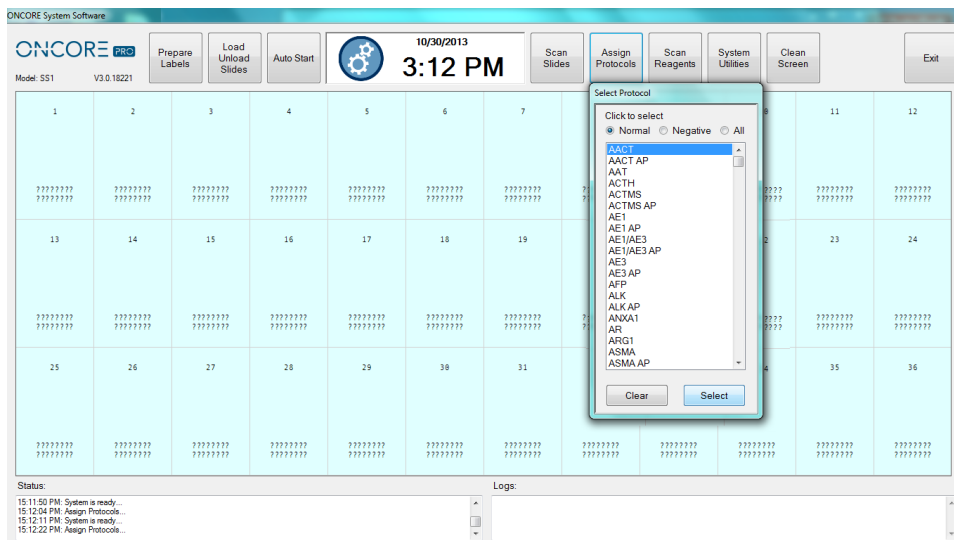

Figure 24



Click “**Assign Protocol**” to open the **Select Protocol** screen.

- A. Click to select **Normal** to access the list of normal protocols.
- B. Click to select **Negative** to access the list of negative control protocols.
- C. Click to select **All** to access the list of all protocols.

Scroll through the protocol list, highlight the desired protocol, and click “**Select**” to assign the protocol to the highlighted slides.

Click “**Clear**” to cancel the selection and close the window.

*Tip: The user may quickly scroll through the protocol list by typing the first few letters of the protocol name.*

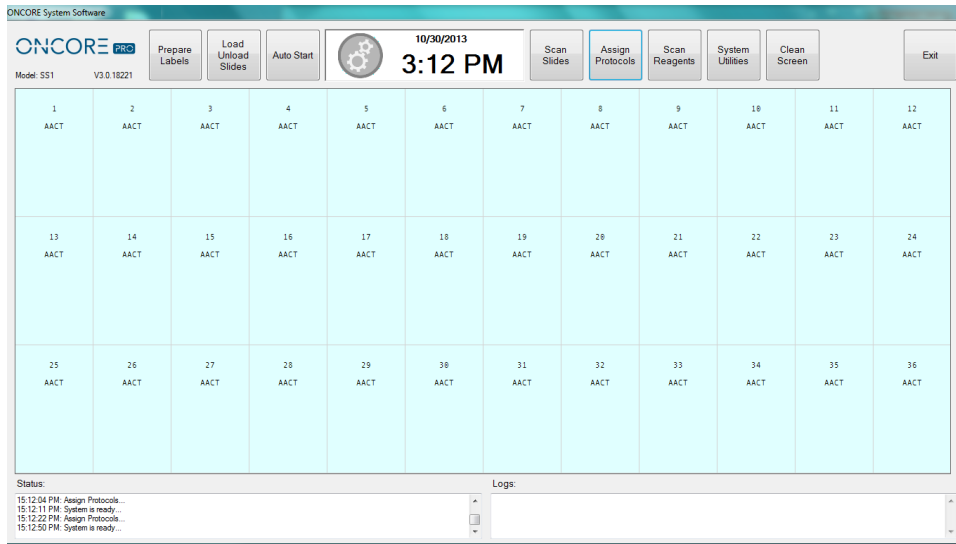

Figure 25

**To clear the protocol assignment(s)**, click + drag to highlight the slide position(s), and then click + drag once more to remove the assignment(s). Alternatively, click “**Clean Screen**” to clear the entire slide map.

## 4.5. Loading Reagents

Oncore Pro detection kits, ancillary reagents and antibody/probe products are shipped ready-to-use. Refer to the manufacturer's Datasheet and SDS for specific instructions.

Prepare all other reagent solutions following the manufacturer's instructions.

*Note: Only Oncore Pro reagent vials are compatible with the Oncore Pro Slide Stainer system. Refer to the vialing specifications in **Reagent Vialing Specifications** p.28, for additional information on vialing and recommended reagent volumes.*

Load the reagent vials onto the reagent rack and **remove all caps**.

*Note: The user may roughly assess the reagent volume remaining in each vial using the volume indicator lines located along the side of the vial. The required reagent volumes for the run are displayed on the right side of the Reagent Check screen. Refer to **Reagent Check: Scan Reagents**, p. **Error! Bookmark not defined.***

**CAUTION! Evaporation will cause gradual loss of volume within the reagent vial. Avoid leaving the reagent vials open for a prolonged time. Close all caps and refrigerate reagent vials immediately after use.**

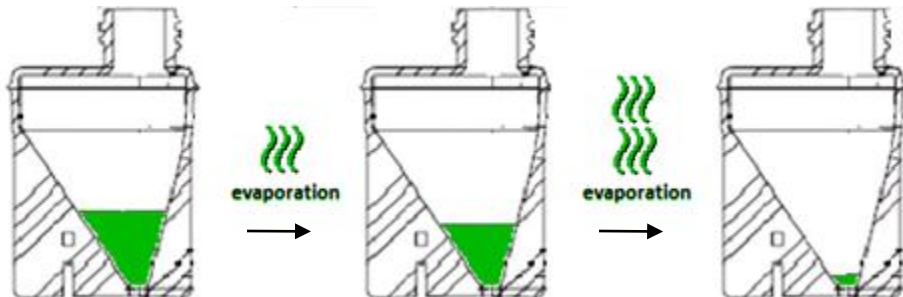

*Please note that the reagent volume may be significantly reduced by evaporation after performing several overnight runs and/or after performing multiple runs using the same reagent vial. This particularly impacts antibodies that are not routinely run on the system (consuming only 1-2 tests per run over 20+ runs). Under such circumstances, the reagent vials will empty prematurely or trigger a low volume warning before the RFID test number reaches 0. To minimize evaporation in such cases, users should attempt to aggregate slides sharing the same antibody/protocol to run those slides in larger batches over a reduced number of staining runs. Meanwhile, users should monitor the test volume and refill/reprogram those affected vials if the volume becomes too low.*

Multiple vials of the same reagent may be placed on the rack. The system will prioritize the use of vials with the earliest expiration date or the least number of tests remaining. *Refer to **Reagent Consumption Priority**, p. 70.*

- A. For on-rack mixing of reagents, place an empty 7mL vial in the designated position #40 and/or #39 as prompted by the system.
- B. For on-board mixing of reagents, avoid placing the second reagent component, Reagent B, in the last two rows of the reagent rack as the Z2 probe will be unable to reach it.

Load the reagent rack onto the designated reagent plate on the instrument.

Verify that the rack is fully seated on the plate, and is oriented correctly, as shown in the figure below.

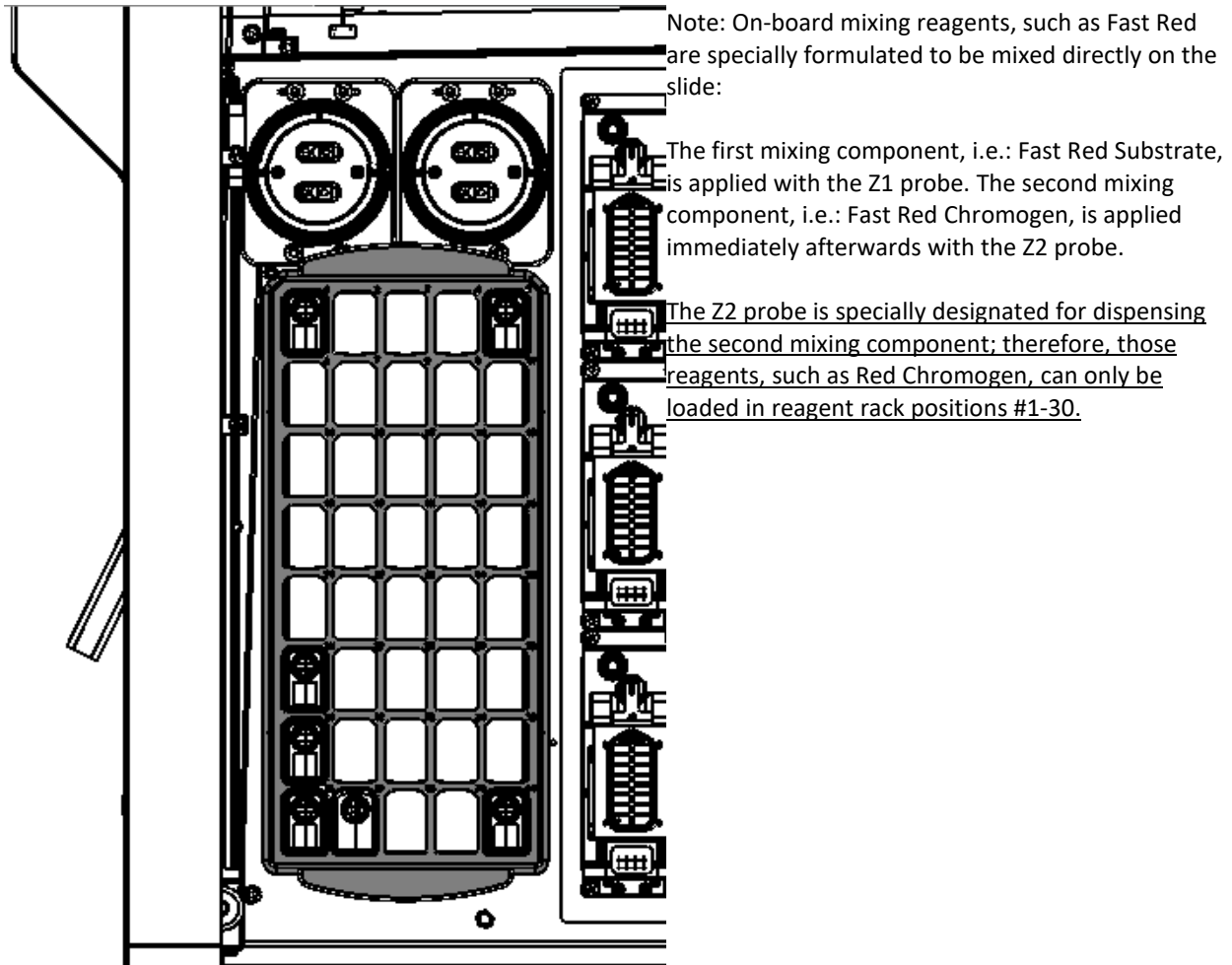



Figure 26

## 4.6. Reagent Vialing Specifications

The Oncore Pro Slide Stainer system provides user-fillable reagent vials for special reagents, uncommon antibodies, and custom ab titers. Each vial is packaged with an RFID tag, cap, and a blank label.

 Use of unauthorized reagents on the system may cause damage to instrument components and will revoke the manufacturer's warranty.

The clear vial option is designated for general use.

The dark vial option is designated for light-sensitive reagents such as probes and chromogens.

*Contact Customer Service for ordering information.*

### 7mL Reagent Vial Specifications

The **7mL** vial is specially designed for efficient use of antibodies and probes by minimizing dead volume.

Max capacity 9mL. *Note: Although the 7mL vial can hold up to 9mL, it is recommended to fill below 7.5mL to avoid triggering liquid volume errors.*

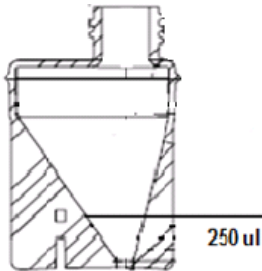

Figure 27

The **dead volume** for a 7mL vial is ~250uL.

### 15mL Reagent Vial Specifications

The **15mL** vial is designed to hold larger volumes of reagent.

Max capacity 16mL.

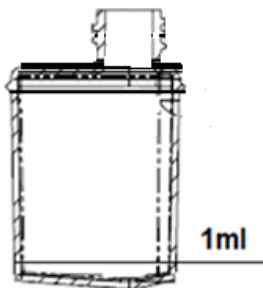

Figure 28

The **dead volume** for a 15mL vial is ~1000uL.

## Instructions for Use

Fill the reagent vial with the appropriate amount of reagent solution.

*Tip: Use the Reagent Check screen to quickly obtain a list of required reagent volumes, then add 1mL dead volume for a 15mL vial or add 250uL for a 7mL vial.*

Label the reagent vial and cap.

Program the RFID tag. Refer to **Preparing RFID Tags with the RFID Tag Editor**, p. 60 , for more details.

Note: Some reagents are listed under multiple reagent types i.e.: AP and HRP. Select the reagent from any one of the applicable Reagent Type categories in the RFID Editor to program the RFID tag.

### To calculate the required volume:

**Volume = number of tests\* x protocol volume x draw factor 1.08\*\* + dead volume\*\*\* of the vial**

*Note1\*:* It is advised to fill a lower number of tests per vial for reagents that are volatile or less chemically stable, and for reagents that are not routinely used.

*Note2\*:* An additional 8% extra volume (**or more**) is required to compensate for reagent evaporation and the amount adhering to the internal surface of the tubing and external surface of the aspiration probe.

*Note2\*\*\*:* The reagent volume may be significantly reduced by evaporation over several overnight runs or over multiple staining runs. In such cases, users may need to increase the dead volume or refill vials more frequently.

## 4.7. Refill Buffer and Empty Waste

The system will prompt the user to verify the required Wash Buffer and Waste Container volumes before proceeding with the staining run.



Figure 29

### Refill the Wash Buffer Bottle

The standard Wash Buffer Container has a maximum capacity of 2000mL.

1. Click System Utilities>Tools>"Move Arm Aside" to access the Wash Buffer Container located on the inner left side of the instrument.
2. Disconnect the Wash Buffer Container and remove it from the instrument.
3. Refill the Wash Buffer Container.
4. Reconnect the Wash Buffer Container and place it back onto the instrument.
5. Prime Z1 and Z2 and visually inspect the lines to ensure that air is not present.

### Empty the Waste Containers

The standard Waste Containers have a maximum capacity of 4000mL, with a secondary containment provided for each waste container.

1. Disconnect the waste tubing from the Waste Container cap.
2. Empty the Waste Container. Dispose of the waste according to local regulations.
3. Reconnect the waste tubing.
4. Verify that the waste tubing is draining properly.



Figure 30

## 4.8. Reagent Check: Scan Reagents

  **Remove all reagent vial caps before proceeding.**

From the Main screen, click “Scan Reagents” to open the **Reagent Check** screen. The reagent map is displayed on the left and a table of reagents required for the run is displayed on the right.

*Tip: Click “Print Required Reagents” to print the list of required reagents. A network or USB printer is required.*

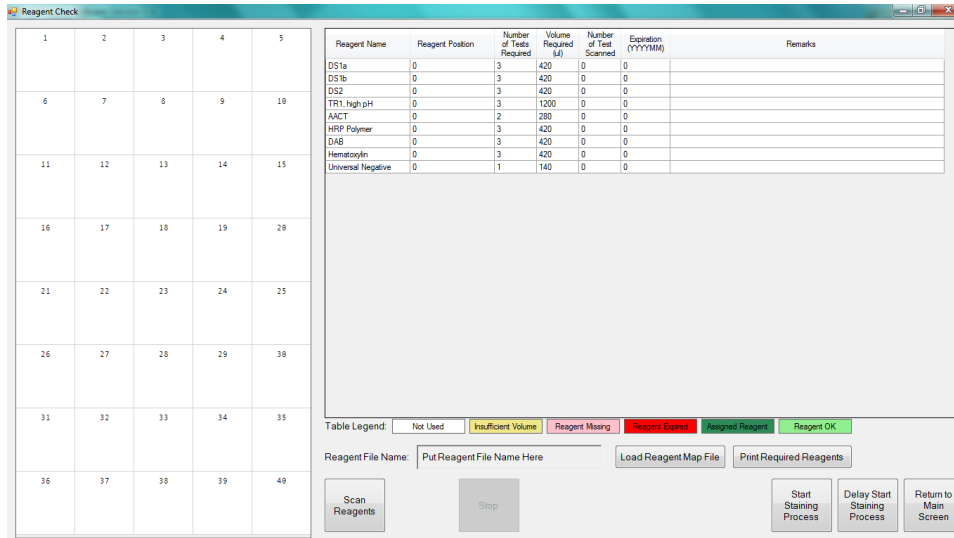

Figure 31

To scan all reagents with the RFID reader, close the door and click “Scan Reagents”. The robotic arm will move the RFID reader antenna over each reagent vial position and read out the stored RFID tag information. The system will continue scanning until all required reagents have been detected or all 40 positions have been scanned.

*Tip1: Click + drag to select specific reagent vial positions to scan.*

*Tip2: Click “Stop” to stop the scan while it is in progress.*

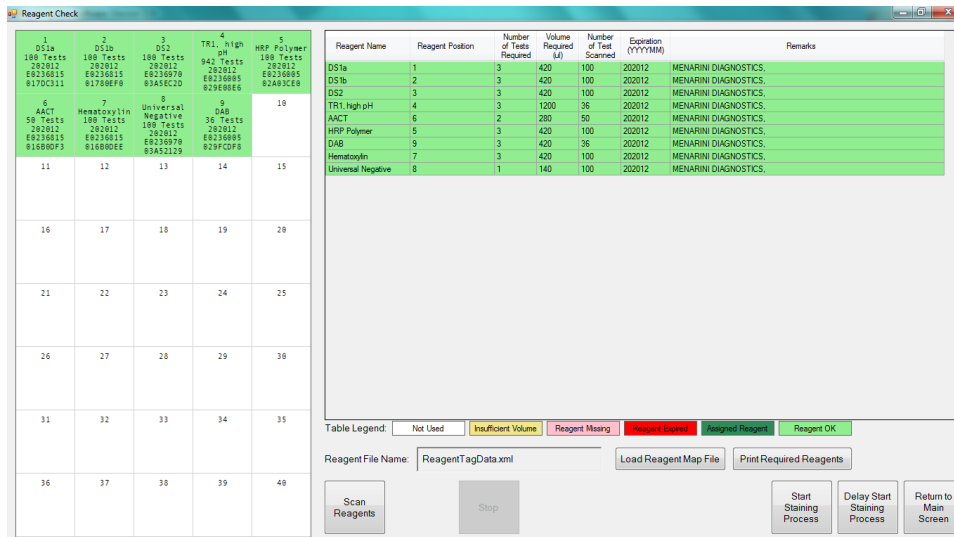

Figure 32

The scanned reagent assignments are displayed on the reagent map on the left. Each scanned reagent vial will be displayed with the following:

- A. Reagent name.
- B. Number of tests remaining. Updates during the staining process each time reagent is aspirated.
- C. Expiration date.
- D. Unique RFID tag ID. Provides traceability for the individual reagent vials across different runs.

After completing the scan, the system will display the current status of the reagents:

- A. All **expired** reagents are highlighted in **red** and must be replaced.
- B. All **missing** reagents are highlighted in **pink**.
- C. All reagents with **insufficient** number of tests are highlighted in **yellow**.
- D. All reagents **ready** for the staining run are highlighted in **green**.
- E. All reagents **not used** will remain with a white background.
- F. All RFID tags that produced an error during scanning are highlighted in **red** and must be replaced.

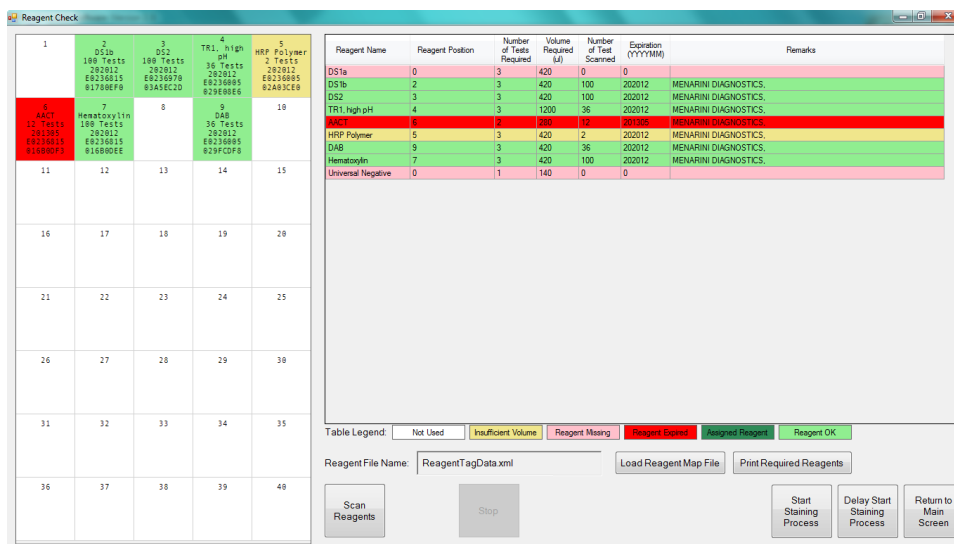

Figure 33

The user must add additional vials when the reagent is insufficient or missing. Up to 5 vials of the same reagent may be placed on the rack. Manual assignment or a re-scan of the reagent rack is required to proceed.

*Note: A warning will appear when insufficient reagent is detected. Additional tests may be added either by 1) refilling the reagent vial and reprogramming the test number, or 2) adding additional vials of reagent. Upon re-scan, the reagent will highlight in green once the test number is found to be sufficient.*

**To manually assign a missing reagent to the Reagent Map**, select the missing reagent in the table on the right; the line will now be highlighted in blue. Then click a position on the reagent map to assign the exact number of tests required to this reagent rack position.

**⚠ Note:** The user has the capability to manually assign missing or insufficient reagents; however, it is recommended to reserve its use only in the case of an RFID reader or RFID tag failure. Manually assigned reagents cannot be tracked by the system, so it will be the user’s responsibility to keep track of the vial contents and gauge the number of tests remaining.



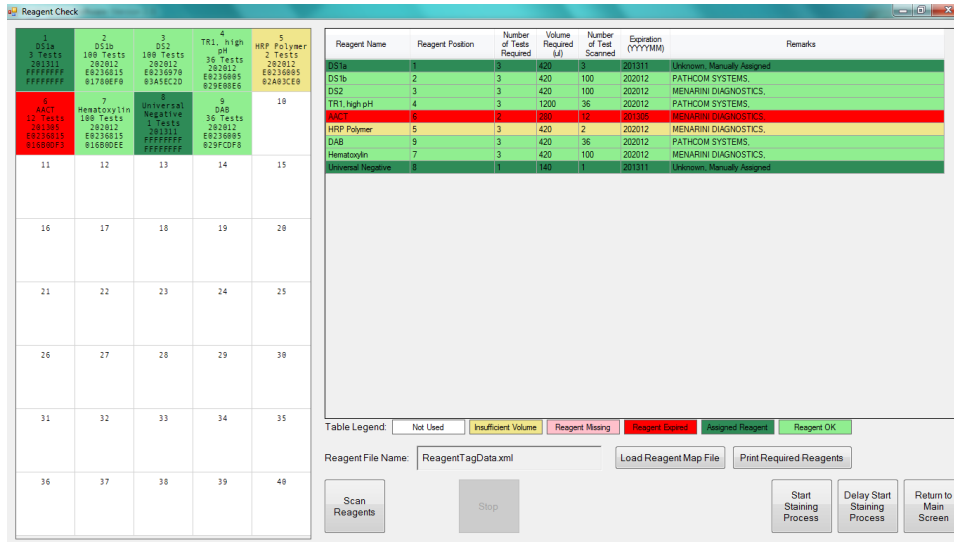

Figure 34

The manual assignments will be saved until the reagent rack is scanned again.

G. All **manually added** reagents are highlighted in **dark green**.



Always verify that the manually assigned reagent is placed in its corresponding position on the Reagent Rack and that it has sufficient volume before proceeding.

For more information on reading and writing RFID tags, refer to *Preparing RFID Reagent Tags with the RFID Tag Editor* p. 60.

To review a previously run Reagent Map, click “Load Reagent Map File” and select the map file from the list of reagent map logs. Each log is labeled with the date and time of the run. Open the log and it will be displayed on the reagent map on the left.

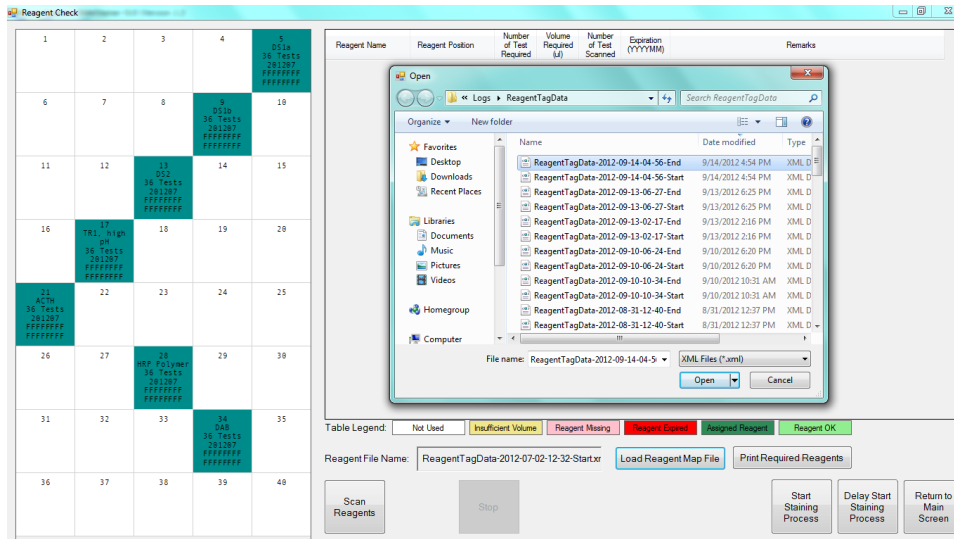



Figure 35

## 4.9. Starting the Run

To immediately start the run, close the door and click “Start Staining Process” from the Reagent Check screen.

 Verify that all caps have been removed from the reagent vials before starting the staining process.

 **Close the door before starting the run.** The door will lock and block unsafe access to the instrument while it is in operation. The staining run will not proceed while the door is open.

The system will initialize and lock the door, then proceed to calculate the most efficient schedule to complete the staining run. Longer protocols are prioritized over shorter protocols to enable the slides to finish at a similar time.

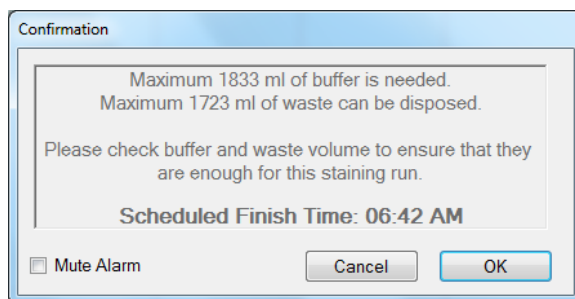

Figure 36

Once all calculations are complete, the system will unlock the door and prompt the user to verify the volume of in-line wash buffer and the remaining waste capacity.

- A. The robotic arm will automatically move to the center of the instrument to allow the user to add more buffer if needed.
- B. The waste containers are located under the instrument work surface and should be emptied as needed. *Note: The calculated waste volume reflects the total volume of waste, combining both hazardous and non-hazardous waste. In the event of an overflow of the non-hazardous waste station, all waste will be dispensed into the hazardous waste container. Therefore, it is important to ensure that both waste containers have sufficient capacity.*

Refer to *Refill Buffer and Empty Waste*, p.29, for more information.

**Click “OK” to proceed with the staining process.**

 **The staining process will not proceed until the user completes this verification step.**

As the instrument prepares to start the run, the system will prime each pump three times over the wash stations to fill the in-line tubing. A run timer will appear at the top of the screen, counting down the expected time remaining until the end of the run.

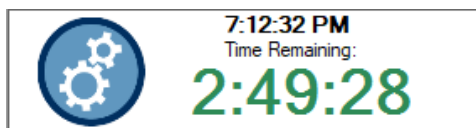

Figure 37

*Tip: Runtime will vary depending on the protocol template(s) used and the run complexity (number of slides and types of protocols selected). Selecting more slides and several protocols running multiple detection systems will result in a longer runtime. To increase overall lab throughput, it is recommended to run shorter runs during the day and save longer, more complex runs for overnight.*

**To delay the start of the run to a later date or time, click “Delay Start Staining Process” from the Reagent Check screen:**



Figure 38

Enter the **Date** and **Time** that the run is expected to finish.

The system will calculate the delay time and initiate a countdown. When **Time Left to Start** reaches **0:00:00**, the system will automatically begin the staining process.

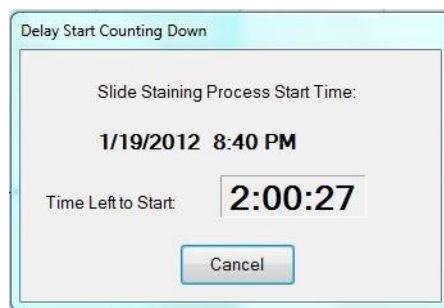

Figure 39

*Tip: Use Delay Start on overnight runs to prevent processed slides from drying out.*

## Gantt Chart

The current run schedule is displayed on the Gantt chart. This may aid in tracking the progress of the run and determining the wait time for loading/unloading slides.

To view the Gantt chart, expand the AutoStainer Server window from the taskbar and click the Gantt tab.

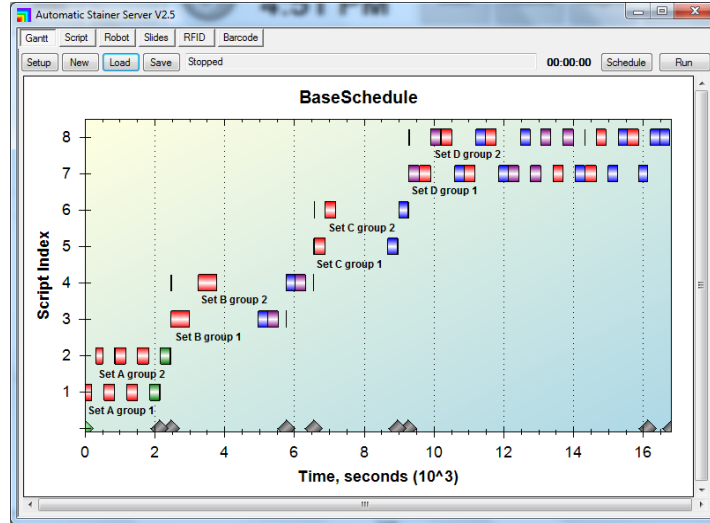

Figure 40

The purple line tracks the progress of the staining run. The time is measured in thousands of seconds.

Each bar represents a batch step for a group of slides. The maximum group size is 18.

- 1) The red bar represents a reagent addition step.
- 2) The blue bar represents a quick wash step using wash buffer.
- 3) The green bar represents a quick wash step using a reagent
- 4) The purple bar represents an incubated wash step.
- 5) (Special) The brown bar represents a linked mixing step of 2 RTU reagents.

## 4.10. Auto Start

The Auto Start feature may be used to start the staining process directly from the Main screen. The system will automatically proceed from scan slides to scan reagents and skip the buffer and waste verification step to immediately start the run. This may reduce instrument startup time.

This feature requires certain setup conditions for use:

- A. The user has loaded all slides onto the instrument and labelled with a 2D barcode.
- B. The user has loaded all required reagents onto the instrument and pre-programmed each vial with an RFID tag.
- C. The user has verified that the buffer volume and waste capacity are sufficient.

**To use Auto Start**, close the door and click “**Auto Start**” on the Main screen and enter the number of slides loaded onto the instrument.

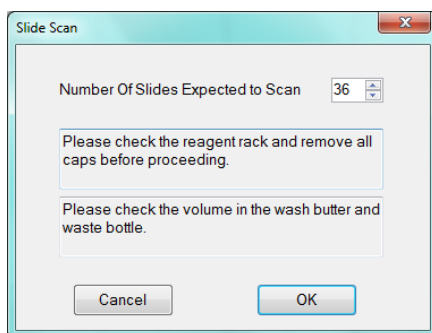

Figure 41

## 4.11. Completing a Run

The system will remain locked while the staining run is in progress. Limited access is provided to prepare labels.

**⚠ In the case of an emergency, click “Exit” to abort the staining run. All run progress will be lost.**

Please heed the following precautions while the run is in progress:

**⚠ Disable Wi-Fi and local internet connection.**

**⚠ Do not attempt to log in/out of Windows or switch users while the instrument is still in operation.** This will cause a fatal system error and cause the system to crash.

**⚠ Do not attempt to run other applications in the background when the instrument is in operation** i.e.: Team Viewer/remote control session, Windows Update, Internet Explorer, Antivirus etc., as it may result in an unexpected system crash.

**⚠ Do not attempt to change file/folder settings or screen display/appearance settings when the instrument is in operation** ie: locking the Taskbar, as it may result in an unexpected system crash.

**⚠ The Autostainer Server, Robot, Slide Processor, and RFID Processor Terminals** will be running while the instrument is in operation. Do not attempt to close any of these applications as it may result in an unexpected system crash.



Figure 42

## Runtime Monitoring

While the instrument is running, the user may track the progress of the run from the Main screen. The slide map displays all 36 slides and displays the protocol, time, and the current step at each slide position. A system log is displayed at the bottom of the screen.

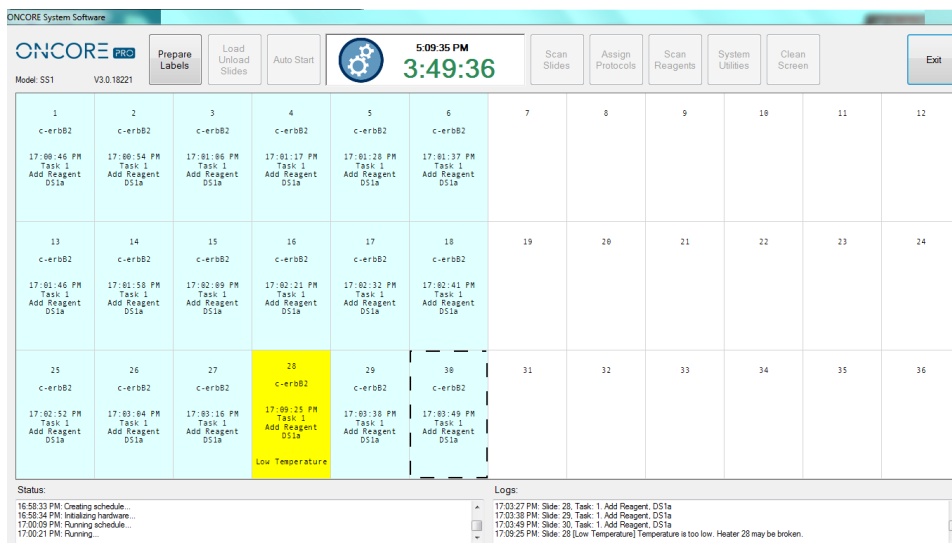

Figure 43

The system monitors the instrument for errors during the course of the staining run. If it encounters any notable errors during its operation, it will attempt to recover from the error and proceed to the next step. Any slide(s) that may have been affected by the error will be marked in **yellow** and labeled with the step in which the first error occurred. The user is advised to verify the staining results of potentially affected slides and review the Slide Report. *Contact Technical Support if encountering persistent system errors.*

- A. The system monitors the heater temperature during the course of the staining run. If a heater fails to heat or cool down to the temperature set point, its position on the slide map will be marked in **yellow** and display a “**Low Temperature**” or “**Overheating**” warning. The user is advised to perform a heater check after the run to verify heater function. *Refer to **Check for Module Malfunction**, p. 49, for more information.*
- B. The system monitors the module function during the course of the staining run. If a module fails, its position on the slide map will be marked in **red** and display a “**Module Malfunction**” warning. The module will be disabled and cannot be used again until the error has been cleared. The user is advised to perform a module check after the run to verify the module function. *Refer to **Check for Module Malfunction**, p. 49, for more information.*
- C. The system verifies the liquid level in the reagent vial before drawing reagents. The Z1 probe is equipped with a liquid level sensor. If a low volume or no liquid is detected, the system will mark all affected slides **yellow** with an “**Low Volume**” warning. The user is advised to verify the volume in the reagent vial(s) after the run and identify potentially affected slides. Reagents that have low conductivity or high viscosity cannot be reliably detected by the liquid level sensor. The system may show a low volume warning for such reagents. In this case, the user may visually inspect the reagent vials to confirm that sufficient volume was available during the staining run.
- D. (If the Overflow Detection option is enabled), the system verifies the liquid level in the waste overflow bin before dispensing waste. If liquid is detected, the system will alert the user of a potential overflow. When an overflow is detected in the non-Hazardous waste, the system will automatically switch over to use the

Hazardous Waste to prevent further overflow. The user is advised to verify that the waste tubing is draining properly and/or empty the waste container(s).

### End of Run

The system will highlight the slides that have successfully completed staining in light green and mark them as “Finished”.

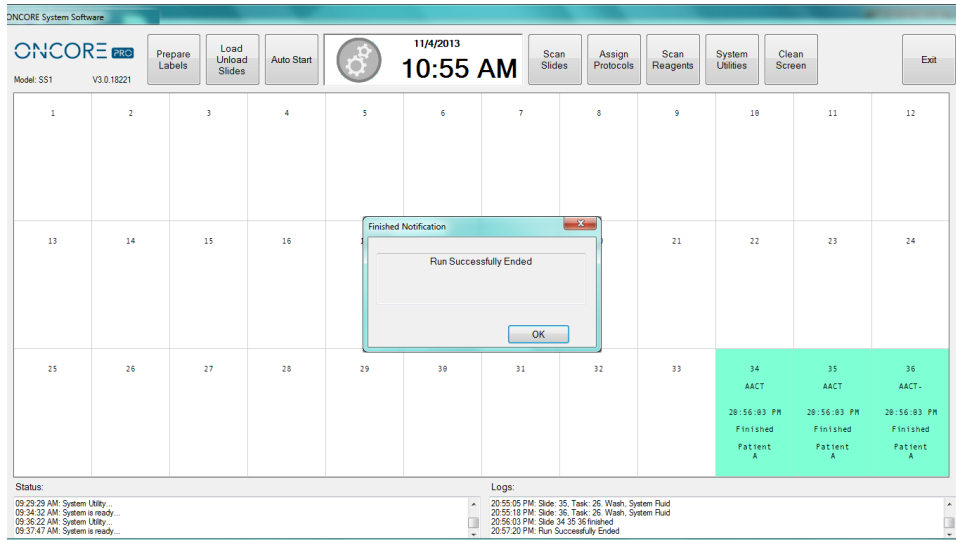

Figure 44

After completing the final step of the run, the system will prime both pumps to clean the syringes, unlock the door and prompt the user: “**Run Successfully Ended**”. The slide chambers are filled with wash buffer during the last step to prevent the slides from drying out before they are unloaded from the system.

However, if an error or warning was encountered during the run, the system will instead prompt the user: “**Run Ended with Warnings**”.

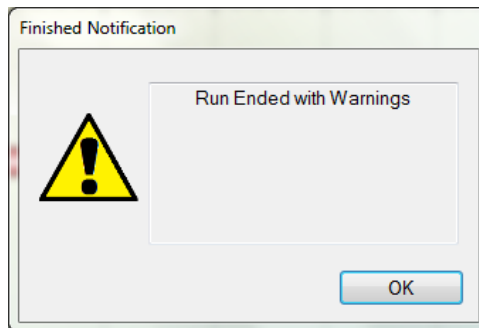



Figure 45

The user can review the slide map and report data to identify the slide(s) which may have been affected by the error. Refer to **Section 6: Reports**, p. 75, for more information.

 **Do not close any Oncore Pro UI applications or shut down the Slide Stainer before the seeing the Finished Notification message.** The instrument may still be in operation.

## Aborting a Run

If the system encounters an irrecoverable error, it will immediately abort the staining process.

The aborted slides will be highlighted in **orange** and the system will prompt the user: **“Run Aborted”**. The staining run progress cannot be recovered upon system abort.

 **Contact service/support to verify that the system abort is not caused by a serious issue on the instrument.**

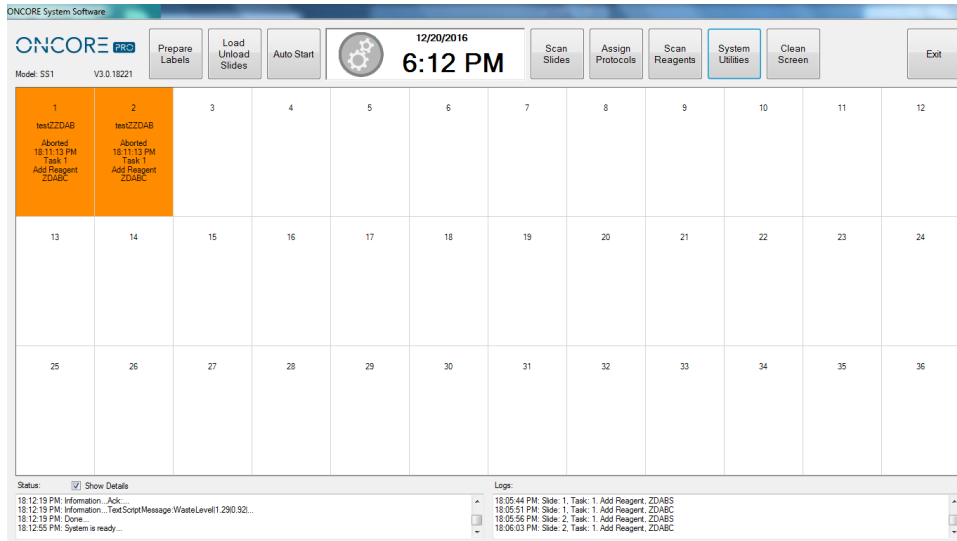

Figure 46

*Note: In an emergency case, the user may manually abort the staining process.*

*Click “Exit” to close the main interface or power off the system to immediately stop the instrument.*



## 4.12. Continuous Loading

The Continuous Loading feature allows users to load more slides after the staining process has already started.

*Note: Using this feature may significantly increase the total run time and delay the finish time for all remaining slides in the run. This feature should not be used for time sensitive reagents such as Fluorescence In-situ Hybridization (FISH). Please call Technical Support for further assistance.*

### Stop the Current Run

To stop the current run, click “Load New Slides”. The system will stop the progress of each slide as it reaches a safe stopping point in its staining protocol. The wait times will vary for each circumstance.

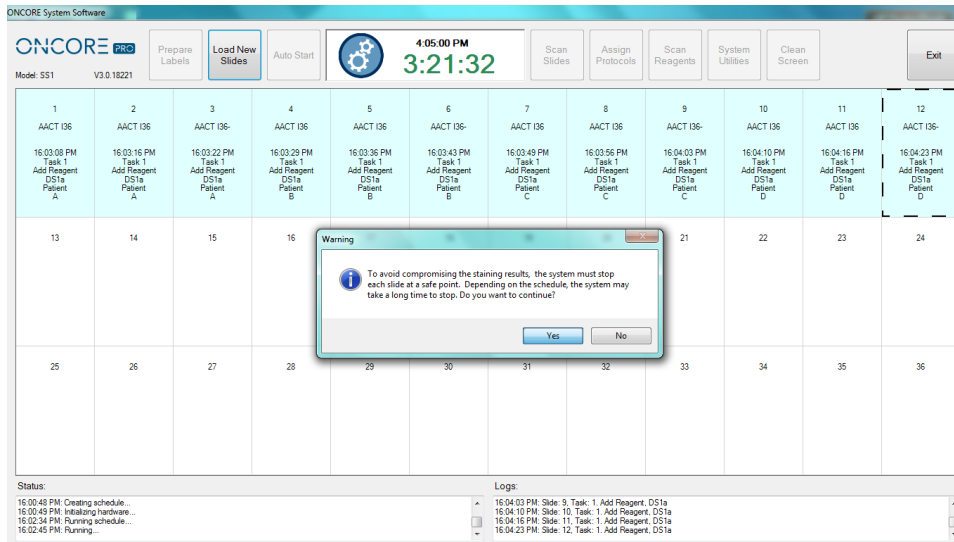

Figure 47

After the system has stopped the progress of all slides, the door will unlock and a popup message will alert the user “Run Successfully Stopped”. The slides that have been stopped will be highlighted in light coral and marked “Stopped”.

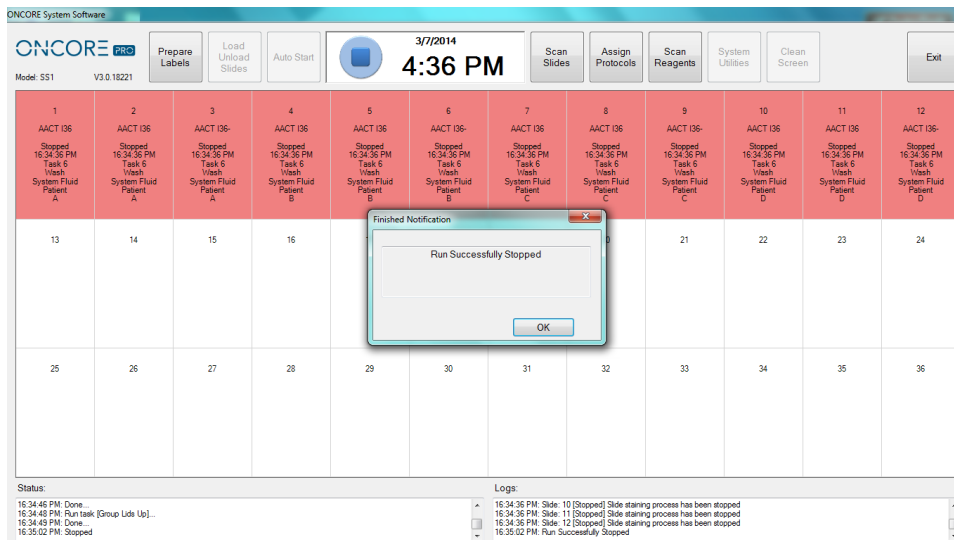

Figure 48

**⚠ Never exit the Main screen after the run has been stopped. The progress on all stopped slides will be deleted and cannot be recovered.**

## Restart the Run

Prepare and load new slides. The system will automatically lift the lids of all available slide positions, including empty positions and positions marked as “Finished”. The positions marked as “Stopped” will be set at the lid Down position and those slides cannot be unloaded from the instrument.

 **Unload all Finished slides before loading any additional slides.**

Scan the new slides to automatically assign the protocols, or manually assign new protocols to the available slide positions. The positions marked as “Stopped” are locked and cannot be assigned a new protocol.

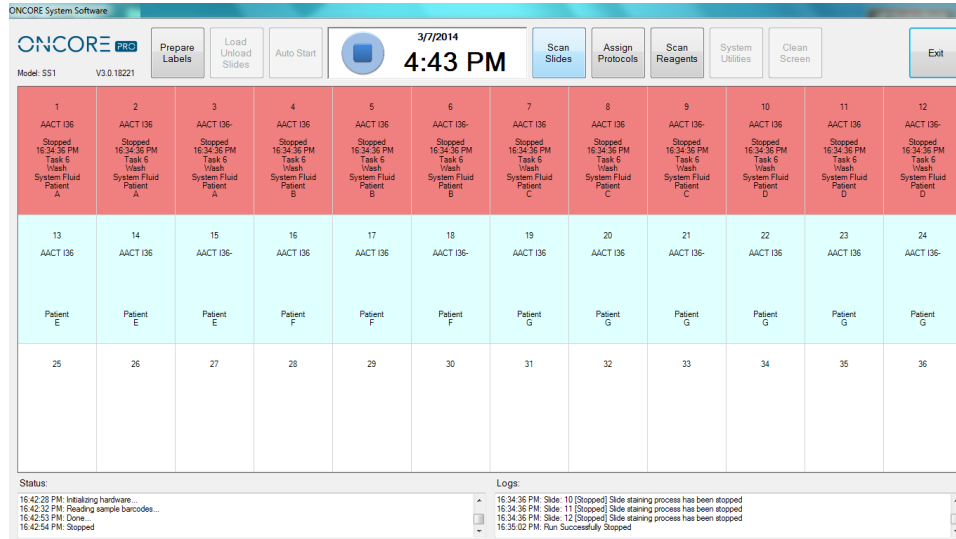

Model: 551 V3.0.18221

Slide #	Protocol	Status	Task	Wash	System Fluid	Patient
1	AACT I36	Stopped	Task 6	Wash	System Fluid	Patient A
2	AACT I36	Stopped	Task 6	Wash	System Fluid	Patient A
3	AACT I36	Stopped	Task 6	Wash	System Fluid	Patient A
4	AACT I36	Stopped	Task 6	Wash	System Fluid	Patient B
5	AACT I36	Stopped	Task 6	Wash	System Fluid	Patient B
6	AACT I36	Stopped	Task 6	Wash	System Fluid	Patient B
7	AACT I36	Stopped	Task 6	Wash	System Fluid	Patient C
8	AACT I36	Stopped	Task 6	Wash	System Fluid	Patient C
9	AACT I36	Stopped	Task 6	Wash	System Fluid	Patient C
10	AACT I36	Stopped	Task 6	Wash	System Fluid	Patient D
11	AACT I36	Stopped	Task 6	Wash	System Fluid	Patient D
12	AACT I36	Stopped	Task 6	Wash	System Fluid	Patient D
13	AACT I36					Patient E
14	AACT I36					Patient E
15	AACT I36					Patient E
16	AACT I36					Patient F
17	AACT I36					Patient F
18	AACT I36					Patient F
19	AACT I36					Patient G
20	AACT I36					Patient G
21	AACT I36					Patient G
22	AACT I36					Patient G
23	AACT I36					Patient G
24	AACT I36					Patient G
25						
26						
27						
28						
29						
30						
31						
32						
33						
34						
35						
36						

Status: 16:42:28 PM: Initializing hardware...  
 16:42:32 PM: Reading sample barcodes...  
 16:42:33 PM: Done.  
 16:42:54 PM: Stopped

Logs: 16:34:36 PM: Slide 10 [Stopped] Slide staining process has been stopped  
 16:34:36 PM: Slide 11 [Stopped] Slide staining process has been stopped  
 16:34:36 PM: Slide 12 [Stopped] Slide staining process has been stopped  
 16:35:02 PM: Run Successfully Stopped

Figure 49

Load any additional reagents that may be required by the new slides and re-scan the reagent rack.

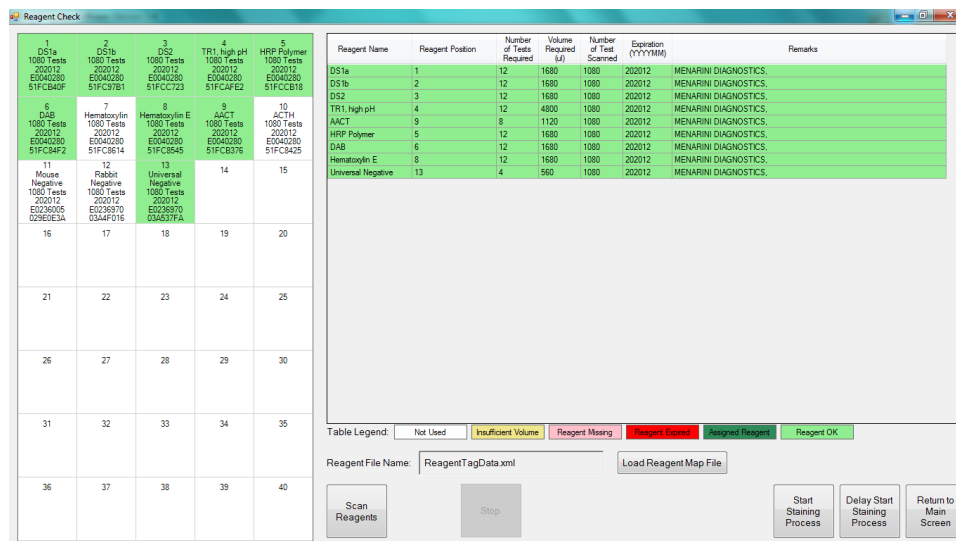

Reagent Name	Reagent Position	Number of Tests	Volume Required	Number of Tests Scanned	Expiration (YYYYMM)	Remarks
DS1a	1	12	1680	1080	20012	MENARINI DIAGNOSTICS.
DS1b	2	12	1680	1080	20012	MENARINI DIAGNOSTICS.
D52	3	12	1680	1080	20012	MENARINI DIAGNOSTICS.
TR1, high pH	4	12	4000	1000	20012	MENARINI DIAGNOSTICS.
AACT	9	8	1120	1080	20012	MENARINI DIAGNOSTICS.
HRP Polymer	5	12	1680	1080	20012	MENARINI DIAGNOSTICS.
DAB	6	12	1680	1080	20012	MENARINI DIAGNOSTICS.
Hematoxylin E	8	12	1680	1080	20012	MENARINI DIAGNOSTICS.
Universal Negative	13	4	560	1080	20012	MENARINI DIAGNOSTICS.

Table Legend: Not Used, Insufficient Volume, Reagent Missing, Reagent Expired, Assigned Reagent, Reagent OK

Reagent File Name: ReagentTagData.xml Load Reagent Map File

Buttons: Scan Reagents, Stop, Start Staining Process, Delay Start Staining Process, Return to Main Screen

Figure 50

Re-start the staining process. The system will reschedule the run to incorporate the new slides. The new slides will take priority and will run separately until they catch up with the Stopped slides. The Stopped slides will resume progress when the new slides have reached the same point as the Stopped slides.

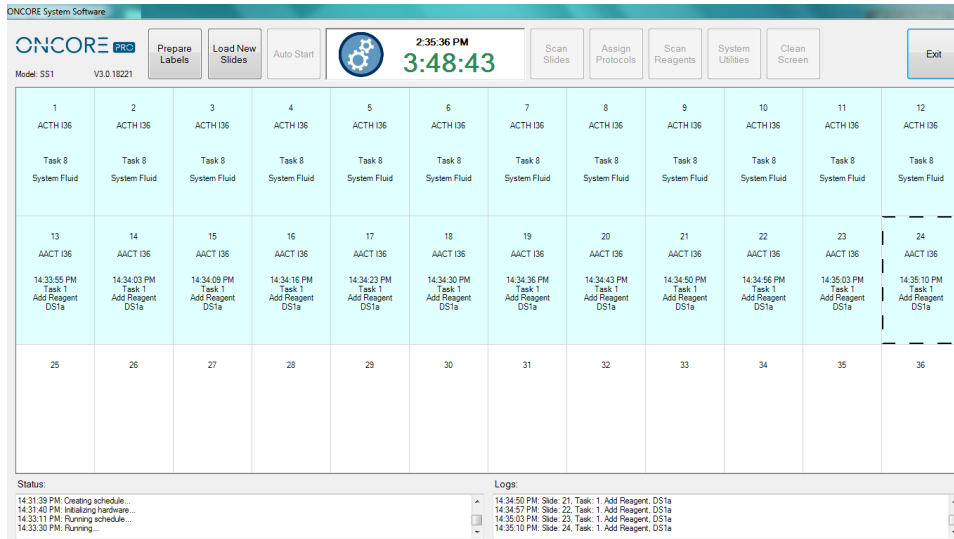

Figure 51

Continuous loading can be repeated on successive steps in the new run schedule; however, the overall runtime for the Stopped slides will increase with each load of slides.

## 4.13. Shutting Down the Slide Stainer

From the Main screen, double click “Exit” to close the program. Click “Yes” to confirm.

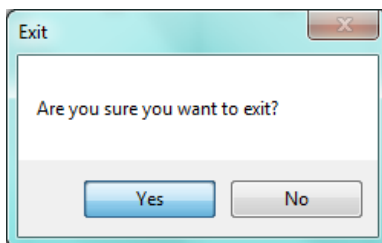

Figure 52

This process may take a few minutes as the system waits for all module lids to go the extract position and for all sub-applications to close. Wait for the application to close completely and return to the login screen before powering off the instrument

Push and hold the power button on the lower right side of the instrument to power down. Wait a few minutes after powering down to ensure the instrument powers down completely.

(Optional) Turn off the power supply switch on the back of the instrument.

Shut down the computer from the Start Menu.

**⚠** **Do not set the module lids to the down position for any extended period of time.** Modules should rest in the extract position when idle.

*Before shutting down the Slide Stainer for an extended period of time (i.e.: long weekends, holidays, transport), prime the pumps and tubing lines with distilled water to prevent excess buildup of salt. Clean the modules with a damp paper towel to remove any residual buffer that may dry along the hinge slot and slip holder.*

## Section 5. System Utilities

From the Main screen, click “**System Utilities**” to access additional utility functions and advanced features. Some features may be restricted depending on user’s security access level. Refer to **Security**, p. 66, for more information.

### 5.1. Tools

Perform manual operations with the system using the functions found under the “**Tools**” tab.

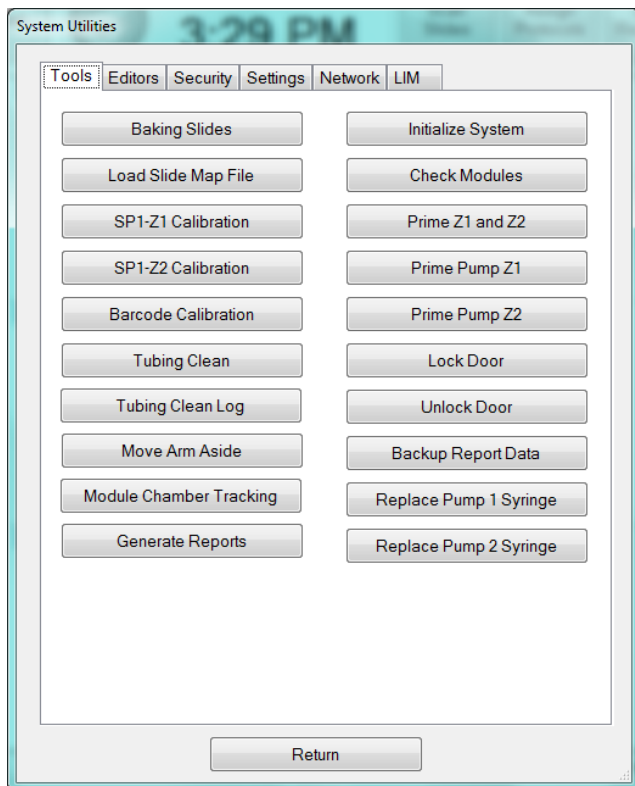

Figure 53

1. Baking Slides
2. Load Slide Map File
3. SP1-Z1 Calibration
4. SP1-Z2 Calibration
5. Barcode Calibration
6. Tubing Clean
7. Move Arm Aside
8. \*(Option) Tubing Clean Log
9. \*(Option) Module Chamber Tracking
10. Generate Reports
11. Initialize System
12. Check Modules
13. Prime Pump Z1 and Z2
14. Prime Pump Z1
15. Prime Pump Z2
16. Lock Door
17. Unlock Door
18. Backup Report Data

*\*Note: Depending on the configuration of the system, some of these functions may not be available.*

## Prepare Slides with Baking Slides Function

Click **"Baking Slides"** to select slides for baking. Check the boxes to select an entire row or select individual slides by module position. Refer to **Baking Slide Settings**, p. 68, for more information.

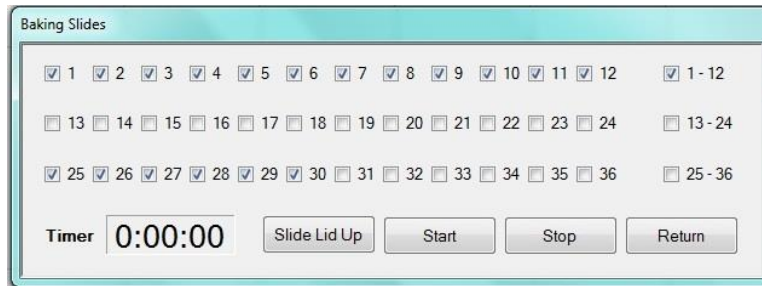

Figure 54

Click **"Start"** to begin baking. The timer on the left will begin counting down and automatically shut heaters off once the timer reaches **0:00:00**.

Click **"Stop"** to manually stop baking.

Refer to **Baking Slides Settings**, p. 68, to set up slides for automatic baking before every run.

## Load a Saved Slide Map File

Click **"Load Slide Map File"** to load and view a previously run slide map on the Main screen. The system automatically saves the slide map file for each set of slides run on the instrument.

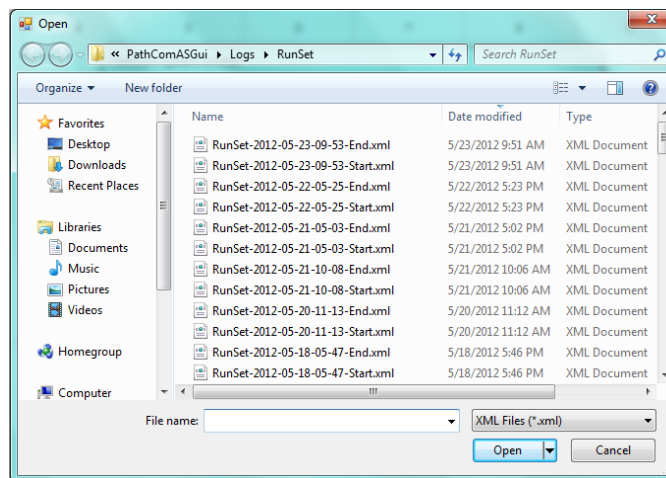

Figure 55

## Verify the Calibration of SP1-Z1 or SP1-Z2

Click **"SP1-Z1 Calibration"** to move the Z1 probe to module #1 and verify the XYZ position of the Z1 probe.

Click **"SP1-Z2 Calibration"** to move the Z2 probe to module #1 and verify the XY-Z position of the Z2 probe.



### Verify the Calibration of the Barcode Reader

Click “Barcode Calibration” to move the Barcode Reader to module #1 and verify the XY position of the barcode reader.

### Clean Z1/Z2 Tubing

Click “Tubing Clean” to open the tubing cleaning feature.

Use the Tubing Cleaning Kit or fill two **15mL** vials with an appropriate cleaning solution.

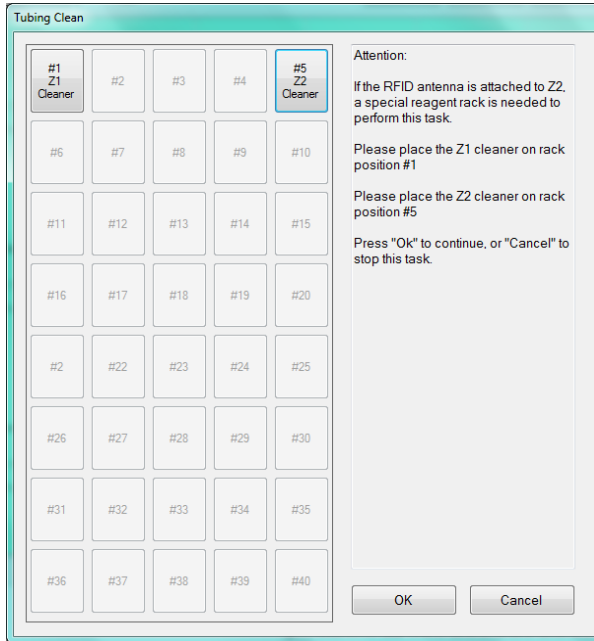

Figure 56

Place Z1 cleaning solution in reagent rack position #1.  
Recommendations: Use 1% **Bleach** to remove Hematoxylin/DAB precipitate in the Z1 tubing.

Place Z2 cleaning solution in reagent rack position #5.  
Recommendations: Use **Slide Brite** to remove wax residues in the Z2 tubing.

Close the door and click “**OK**” to initiate the tubing clean process.

The Z1 and Z2 probes will both aspirate **5mL** of cleaning solution into the tubing from their respective reagent rack positions. The system will then initiate a 20 minute countdown.

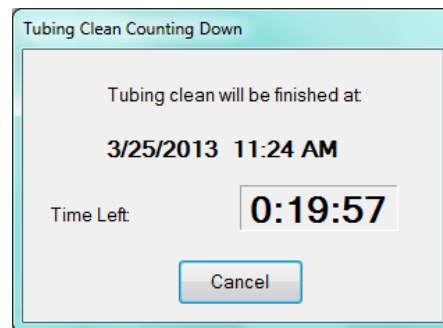

Figure 57

After 20 minutes has elapsed, the system will automatically perform a **System Initialization** and purge the cleaning solution waste.

Click “**Cancel**” at any moment to immediately purge the waste from the tubing.

### (Optional) Access the Tubing Clean Log

If **Tubing Clean Tracking** is enabled, the system tracks the number of slides processed since the last tubing clean. If the total number of slides run exceeds the set threshold, the system will block the user from initiating a new staining process. Refer to **Tubing Clean Tracking Option**, p. 70, for more information.

Click **“Tubing Clean Log”** to review the tubing cleaning status.

Perform a tubing clean to reset the counter or click **“Reset”** to manually set the counter to 0.

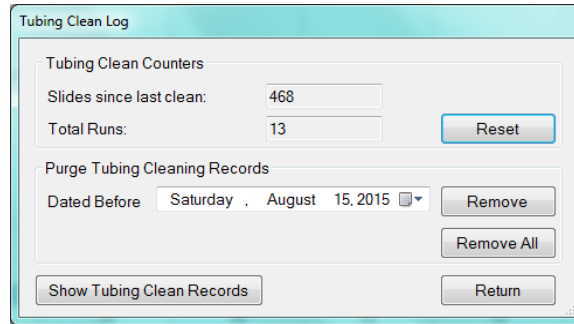

Figure 58

Click **“Show Tubing Clean Records”** to review the entire log of tubing cleans performed to date.

Click **“Remove”** to clear all cleaning records before the set **Date Before**.

(Alternative option) Click **“Remove All”** to clear all tubing records-to-date.

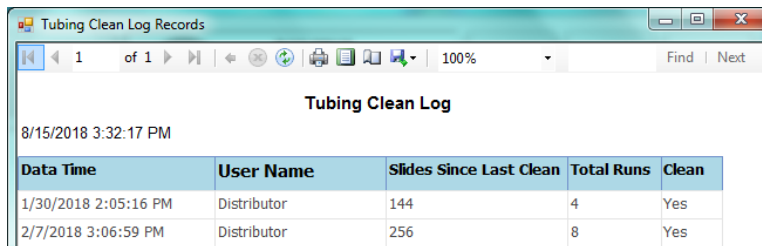

Figure 59

### (Optional) Reset the Module/Chamber Usage Counter

If **Module Chamber Tracking** is enabled, the system tracks the number of slides processed on each module.

If the total number of slides run exceeds the set threshold, the system will display a red warning message to notify the user that it is time to replace the chamber. Refer to **Module Tracking Option**, p. 71, for more information.

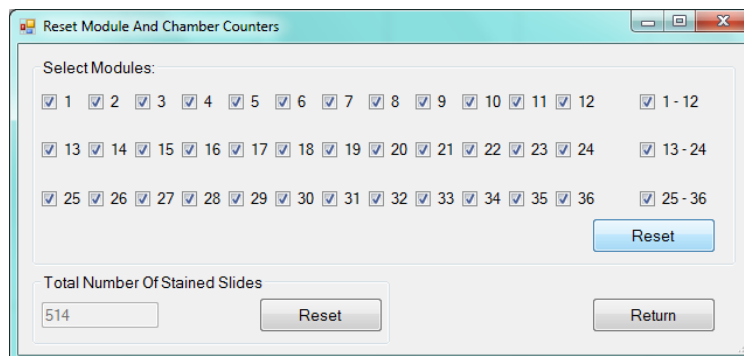

Figure 60

Click **“Reset”** to reset the counter for selected modules back to 0 after replacing the chambers.



## Generate Reports

Click “**Generate Reports**” to open the **Report Generator** utility.  
Refer to **Section 6: Reports**, p. 75, for more information.

## Move Robot XYZZ Arm Aside

Close the door and click “**Move Arm Aside**” to move the robotic arm to the center of the instrument.  
This will enable the user to gain access to the left side of the instrument to fill the buffer bottle and inspect wash stations, pumps (if applicable) etc.

## Perform System Initialization

Close the door and click “**Initialize System**” to initiate system initialization. The robot will initialize the XYZZ axes while all 36 module lids move up to Home. Then each pump will initialize over its respective waste station.

## Check for Module Malfunction

Click “**Check Modules**” to check the function of the modules.  
The Check Modules window will open to display 36 module checkboxes.  
Select the modules using the check boxes then select the option to check:

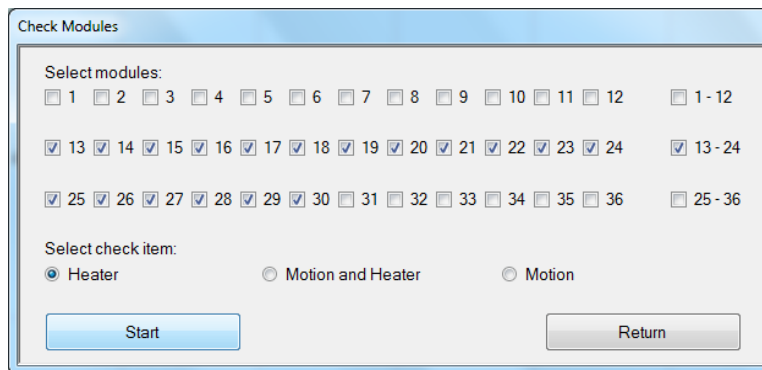

Figure 61

Click “**Start**” to initialize the system and start the countdown timer.  
Click “**Cancel**” to cancel the module check.

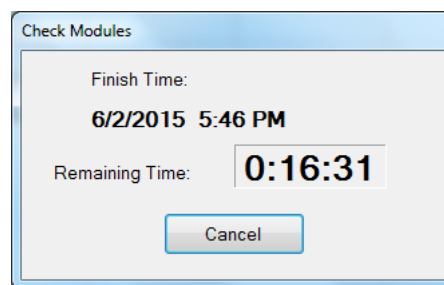

Figure 62

- 1) Select the Heater option to check for heater malfunction.

**⚠ The heaters will take several minutes to heat to higher temperatures during the heater check. To avoid burns/injury, do not resume operation until the heaters have cooled down sufficiently.**

If all the selected heaters pass the heater check, the system will return the message:  
“**All heaters are functioning properly.**”

Otherwise, the system will highlight any malfunctioning heater in **red** on the slide map and mark “Low Temperature” or “Overheating”.

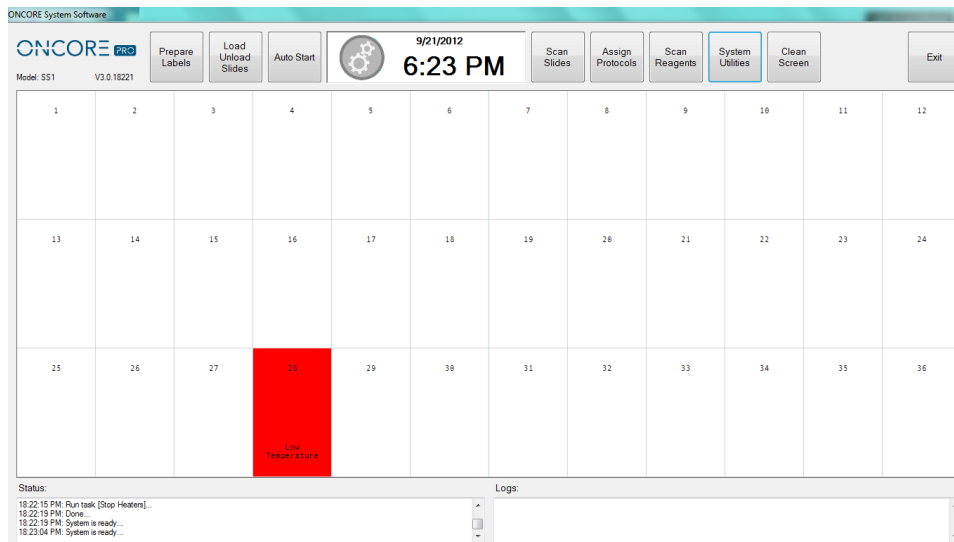

Figure 63

- 2) Select the Motion and Heater option to check for both module motion and heater malfunction. The system will perform both the heater check and the motion check on the selected modules.
- 3) Select the Motion option to check for module motion malfunction only. The system will move the lid to verify all module agitation heights: Home, Extract, Inject and A1-A7. If all the selected modules pass the motion check, the system will return the message: **“All modules are functioning properly.”**

Otherwise, the system will highlight any malfunctioning module in red on the slide map and mark “Module Malfunction”.

**!** Protocols may not be assigned to a slide position with a malfunctioning module until the module is replaced or repaired, and a new module check is performed to clear the error. Contact Customer Service to repair/replace any malfunctioning heaters or modules.

### Flush Tubing with Prime Pump Z1 and Z2 Function

To flush out the tubing, connect a bottle of distilled water. To clear the tubing lines, connect an empty bottle. Click “**Prime Z1 and Z2**” to prime each pump 5x over the waste station.

### Prime Pump Z1 or Pump Z2

Pump 1 is connected to the Z1 tubing line. Click “**Prime Pump Z1**” to check the function of Pump 1. The Z1 probe will move to the wash station and dispense one full draw of buffer.

Pump 2 is connected to the Z2 tubing line. Click “**Prime Pump Z2**” to check the function of Pump 2. The Z2 probe will move to the wash station and dispense one full draw of buffer.

### Lock Door

Click “**Lock Door**” to manually lock the door.

### Unlock Door

Click “**Unlock Door**” to manually unlock the door.

### Backup Report Data

Click “Backup Report Data” to make a backup copy of the report data.  
Refer to **Section 6: Reports**, p.75, for more information.

## 5.2. Editors

Access the protocol, reagent, and RFID editors under the “**Editors**” tab.

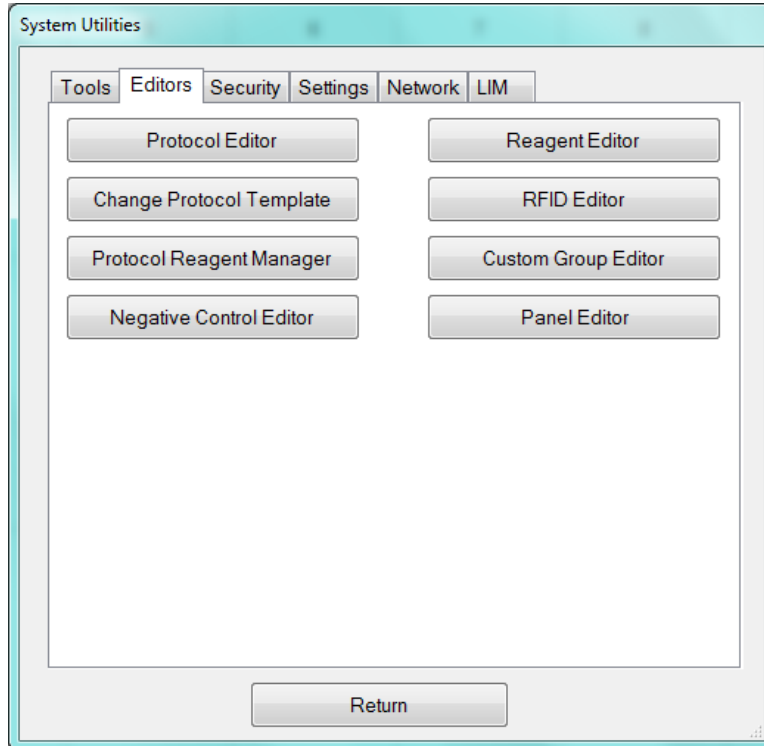

Figure 64

## Editing Protocols in the Protocol Editor

The Oncore Pro is pre-installed with a set of protocols optimized to run on the system. The user may customize certain key steps for each protocol to suit the individual tissue and staining requirements of the lab. If further optimization is required, Technical Support may modify the existing protocol template or create a special protocol. Refer to *Special Protocols*, p.56, for more information.

Click **“Protocol Editor”** to view and modify existing protocols. Protocols are grouped by detection system type under each tab of the editor. Each protocol is generated from a default protocol template assigned to that detection type. Refer to *Changing the Protocol Template*, p. 52, for more information. New protocols may be added in the Reagent Editor. Refer to *Reagent Editor*, p. 59, for more information.

Mark as Changed	Index	Protocol Name	Description	DS Buffer Option	AR Option	Temp (°C)	Block Option	Reagent Name	Time Hour	Min.	Temp (°C)
<input type="checkbox"/>	257	Ber-EP4	Ms HRP Template 1 (V3) Hema	DS2-50	AR2, low pH	80	Buffer	Ber-EP4	0	30	25
<input type="checkbox"/>	103	CD10	Ms HRP Template 1 (V3) Hema	DS2-50	AR1, high pH	101	Buffer	CD10	0	30	25
<input type="checkbox"/>	105	CD15	Ms HRP Template 1 (V3) Hema	DS2-50	AR2, low pH	101	Buffer	CD15	0	30	25
<input type="checkbox"/>	107	CD20	Ms HRP Template 1 (V3) Hema	DS2-50	AR2, low pH	101	Buffer	CD20	0	30	25
<input type="checkbox"/>	203	CD21	Ms HRP Template 1 (V3) Hema	DS2-50	AR2, low pH	103	Buffer	CD21	0	30	25
<input type="checkbox"/>	109	CD23	Ms HRP Template 1 (V3) Hema	DS2-50	AR1, high pH	101	Buffer	CD23	0	30	25
<input type="checkbox"/>	111	CD3	Ms HRP Template 1 (V3) Hema	DS2-50	AR1, high pH	101	Buffer	CD3	0	30	25
<input type="checkbox"/>	113	CD31	Ms HRP Template 1 (V3) Hema	DS2-50	AR1, high pH	101	Buffer	CD31	0	30	25
<input type="checkbox"/>	115	CD34	Ms HRP Template 1 (V3) Hema	DS2-50	AR1, high pH	101	Buffer	CD34	0	30	25
<input type="checkbox"/>	119	CD5	Ms HRP Template 1 (V3) Hema	DS2-50	AR2, low pH	101	Buffer	CD5	0	30	25
<input type="checkbox"/>	205	CD57	Ms HRP Template 1 (V3) Hema	DS2-50	AR2, low pH	103	Buffer	CD57	0	30	25
<input type="checkbox"/>	121	CD68	Ms HRP Template 1 (V3) Hema	DS2-50	AR1, high pH	103	Buffer	CD68	0	30	25
<input type="checkbox"/>	207	CD7	Ms HRP Template 1 (V3) Hema	DS Buffer	AR1, high pH	103	Buffer	CD7	0	30	25
<input type="checkbox"/>	209	CDX2	Ms HRP Template 1 (V3) Hema	DS Buffer	AR1, high pH	103	Buffer	CDX2	0	30	25
<input type="checkbox"/>	211	Chromogranin	Ms HRP Template 1 (V3) Hema	DS Buffer	AR2, low pH	101	Buffer	Chromogranin	0	30	25
<input type="checkbox"/>	123	CK HMW	Ms HRP Template 1 (V3) Hema	DS Buffer	AR2, low pH	95	Buffer	CK HMW	0	30	25
<input type="checkbox"/>	125	CK19	Ms HRP Template 1 (V3) Hema	DS2-50	AR2, low pH	90	Buffer	CK19	0	30	25
<input type="checkbox"/>	127	CK20	Ms HRP Template 1 (V3) Hema	DS2-50	AR2, low pH	101	Buffer	CK20	0	30	25
<input type="checkbox"/>	213	CK5	Ms HRP Template 1 (V3) Hema	DS2-50	AR2, low pH	103	Buffer	CK5	0	30	25

Figure 55

**To customize the DS2 reagent for an IHC protocol, select from the dropdown list under DS Buffer Option.**

- DS2-50. This is the default option. Dewax solution 2 is applied to enhance antigen retrieval.
- DS Buffer. Select this option to apply wash buffer instead of Dewax solution 2. This option may improve morphology or improve over-staining by reducing the strength of antigen retrieval.
- DSE-50. Select this option to apply a protease enzyme incubated at 58°C instead of Dewax Solution 2.

**To customize the TR reagent for an IHC protocol, select n from the dropdown list under AR Option.**

- TR1. This is the default option. Antigen Retrieval solution 1 high pH 9 is applied.
- TR2. Select this option to apply Antigen Retrieval solution 2 low pH 6. This may improve morphology or improve over-staining by reducing the strength of antigen retrieval.
- TR3. Select this option to apply Antigen Retrieval solution 3 for ISH.
- TR Buffer. Select this option to apply wash buffer instead of Antigen Retrieval solution. This option may be used when antigen retrieval is not required. Note: Set incubation temperature to 37 °C.
- TR Enzyme. Select this option to apply a custom enzyme instead of Antigen Retrieval solution. Note: Set incubation temperature to 37 °C. Requires 370uL/test fill volume.

**To customize the Antigen Retrieval incubation temperature for an IHC protocol, adjust the Temp (°C).**

- 101°C is the default temperature for antigen retrieval.
- Reduce the temperature to 98°C/95°C (or lower) to reduce the strength of antigen retrieval.
- Increase the temperature to 103°C to increase the strength of antigen retrieval.
- Reduce the temperature to 37°C if an enzyme or buffer option was selected.

To customize the Block reagent for an IHC protocol, select from the dropdown list under **Block Option**.

- A. Buffer. This is the default option (no blocking step). TR1 is formulated to provide sufficient blocking under most conditions.
- B. Block. Select this option to apply H<sub>2</sub>O<sub>2</sub> block instead of wash buffer.

To customize the Primary Ab incubation time and temperature for an IHC protocol, adjust the **Time** (hours, minutes, seconds) and **Temp** (°C).

- A. 25°C is the default temperature for antibody incubation.
- B. Increase the incubation temperature to 37°C to increase staining intensity.
- C. Decrease the incubation time (minimum 10min) to decrease the staining intensity.
- D. Increase the incubation time to 45min/1hr to increase staining intensity.

Click **“Save”** to apply the customizations to the selected protocol(s). All protocols that have been modified from the manufacturer’s default protocol will be **“Marked as Changed”**.

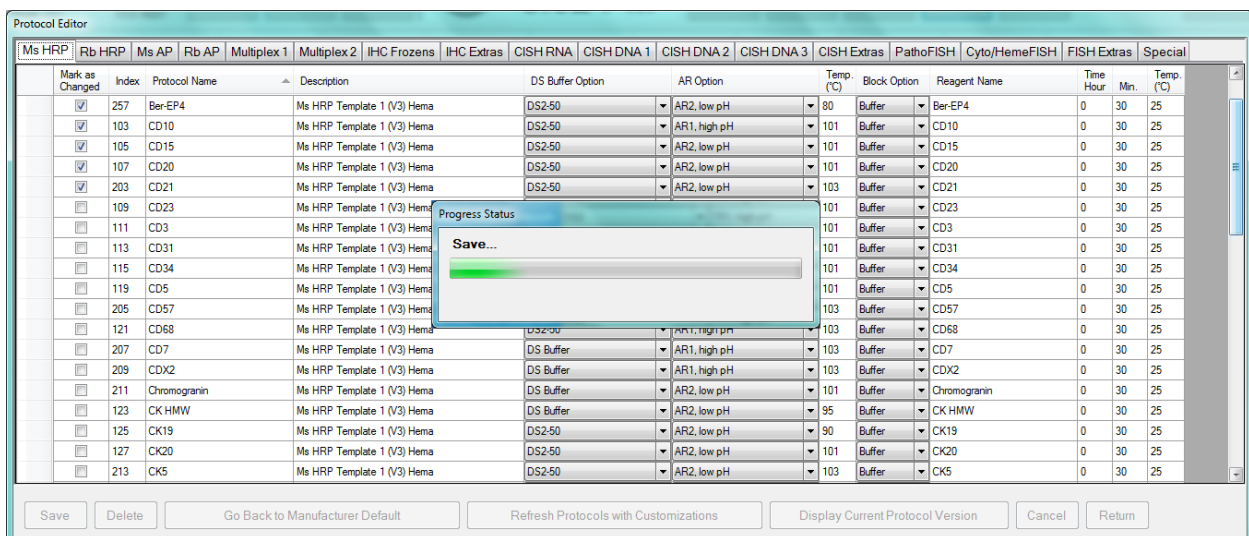



Figure 66

 The user may backup these protocol customizations under System Utilities>Settings and click **“Save All Customizations”**. Refer to p. 70, **Save All Customizations**, for more details.

Click **“Cancel”** to cancel all changes.

Click **“Delete”** to delete the selected protocol. *Note: The manufacturer’s pre-installed protocols cannot be deleted.*

Click **“Return”** to close the Protocol Editor.

Review the current protocol version number by clicking **“Display Current Protocol Version”**. The version number is updated each time the manufacturer releases a new set of manufacturer’s default protocols and reagents. User-added protocols and templates do not affect the version number.

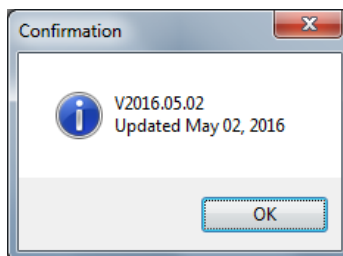



Figure 67

## Restoring Protocol Customizations in the Protocol Editor

In certain circumstances, the user may need to restore the customizations of certain protocols:

- 1) Restore protocol(s) using saved customizations after a temporary change was made.
- 2) Restore protocol(s) using manufacturer's default to reset the system to default or to evaluate control slides.
- 3) Regenerate all protocols after changes were made to the assigned protocol template.

  Backup the protocol customizations if necessary before refreshing the protocols. Any recent customizations that have not been backed up using "Save all Customizations" will be overwritten during the refresh process. Refer to *Save All Customizations*, p. 70, for more details.

To restore the selected protocol(s) using the saved customizations, select the protocol (s) and click "Refresh Protocols with Customizations".

*Tip: The user may select multiple protocols by holding down the Ctrl key or select all protocols in the tab by clicking the left corner grid.*

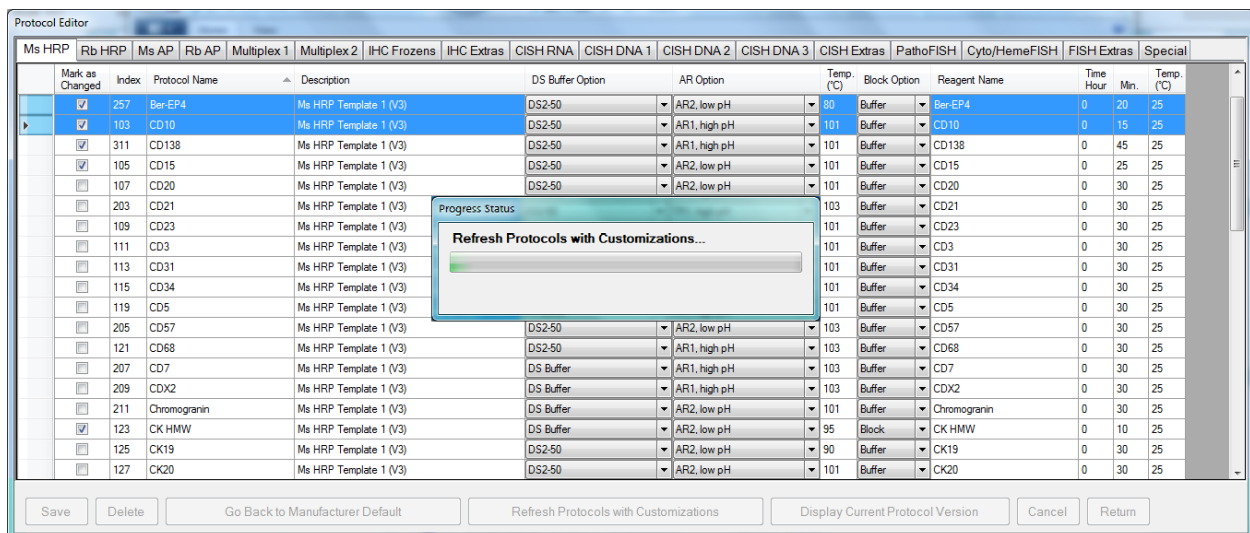

Figure 68

To restore the selected protocol(s) using the default customizations, click "Go Back to Manufacturer Default".

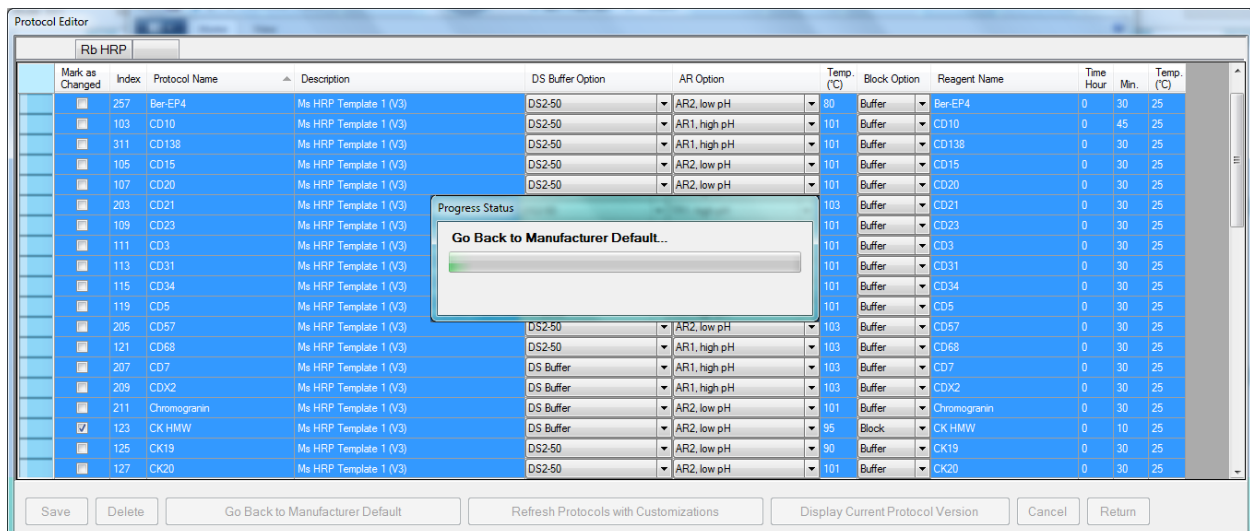

Figure 69

## Editing Protocols in the Protocol Editor: ISH/CISH/FISH

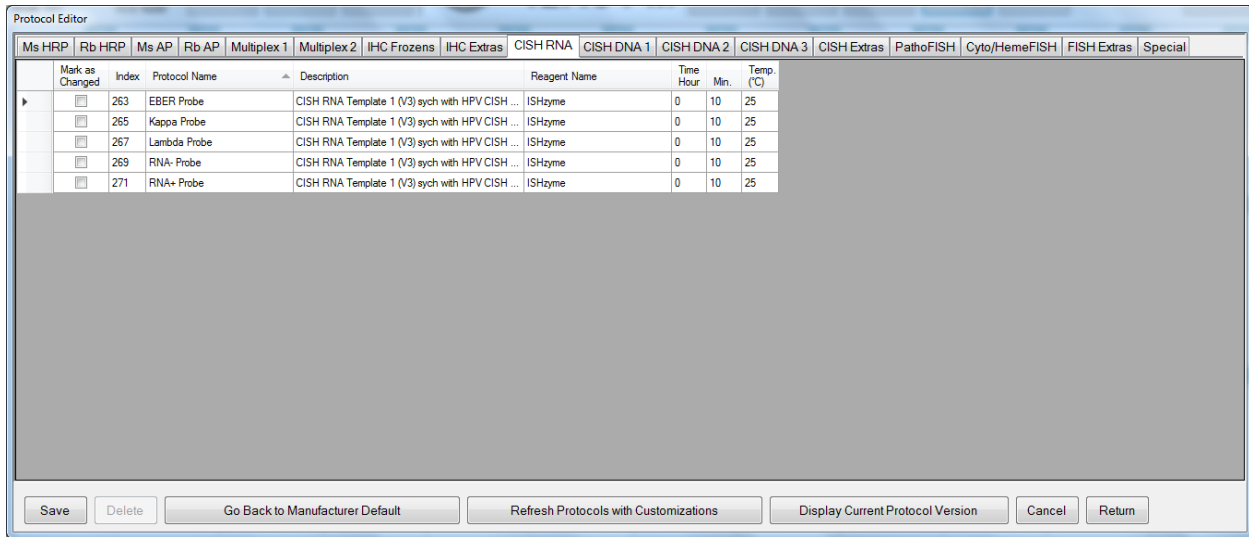

Figure 70

To edit the enzyme incubation time and temperature, adjust the **Time** (hours, minutes, seconds) and **Temp** (°C).

### Viewing Special Protocols in the Protocol Editor

Special protocols are listed under the Special tab. These protocols offer the flexibility to customize any step in the staining protocol. *However, special protocols must be generated in an external application and may be imported to the system using the Protocols and Reagents Manager. Refer to p. 57, **Importing Protocols**. Contact Technical Support for assistance with special protocols.*

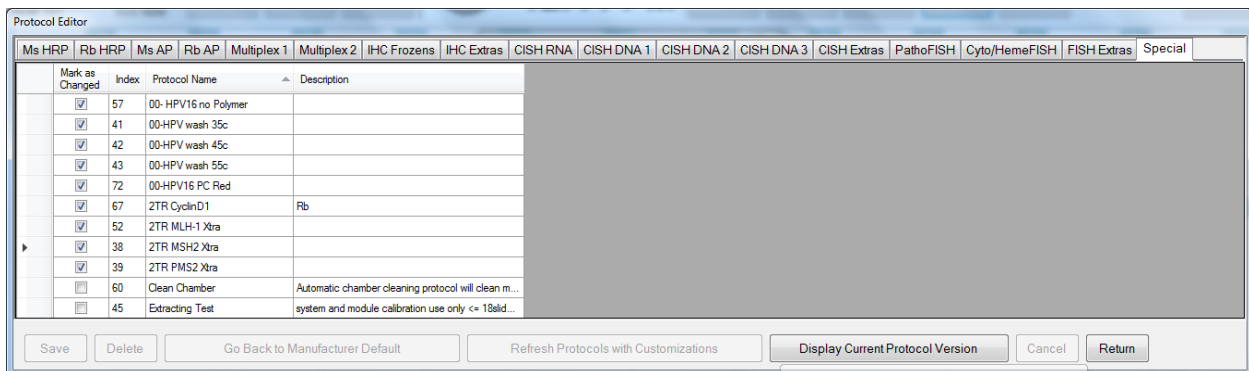

Figure 71

## Changing the Protocol Template

Each type of detection system is assigned one protocol template. This template is used to generate all protocols listed under that type. The user may change the assigned protocol template by selecting a different protocol template.

Click **“Change Protocol Template”** to review the list of protocol templates and change protocol template assignments. If the assigned protocol template is modified or changed to a new template, the change will be applied to all protocols associated with that template.

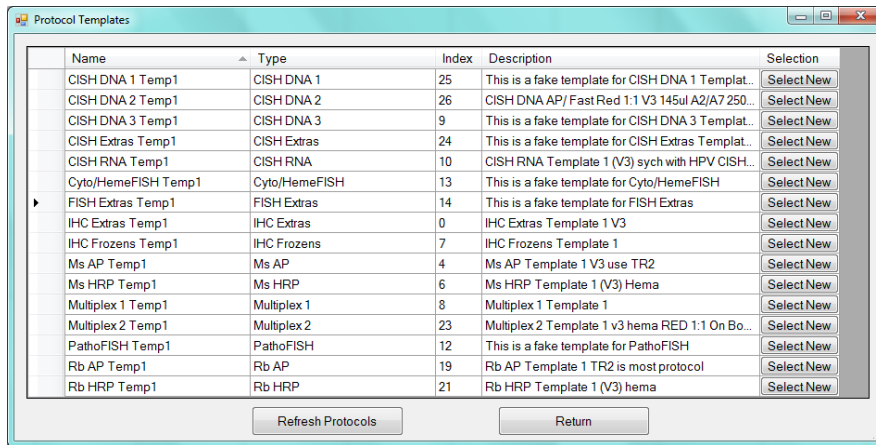

Figure 72

**⚠ Note:** Make sure to save all current protocol customizations in Settings before proceeding. The protocols must be regenerated after changing the protocol template. Any unsaved customizations will be overwritten.

To change to a new protocol template, select the appropriate protocol type and click **“Select New”**. The **“Select Template”** screen will open displaying the available protocol templates:

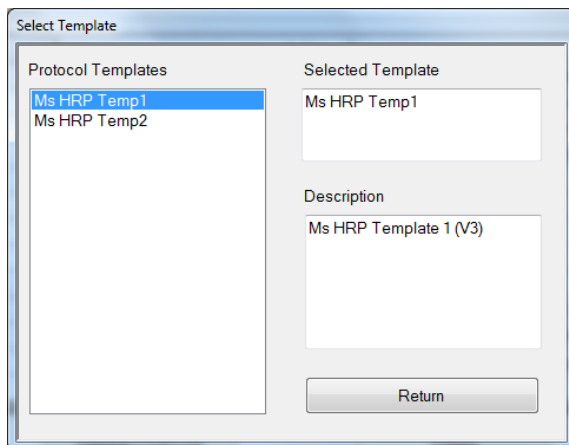

Figure 73

Select a new protocol template from the **Protocol Templates** list and click **“Return”** to close the screen.

*Protocol templates must be generated in an external application and may be imported to the system using the Protocols and Reagents Manager. Contact Technical Support for assistance with creating new protocol templates or modifying existing protocol templates.*

From the **Protocol Templates** screen, click **“Refresh Protocols”** to regenerate all protocols using the new template.

**⚠ Note:** The system will take several minutes to regenerate all protocols and apply the saved protocol customizations. **“Refresh Protocols”** will automatically regenerate protocols for **all** types displayed on the screen, even if new protocol templates were not selected.

Click **“Return”** to close the Protocol Templates screen.



## Importing Protocols in the PR Manager

Export packages are periodically released to the user in order to 1) update protocol templates and protocols, 2) add additional applications and products, or 3) add special protocols. These packages may be imported into the system using the PR Manager utility. *Contact Technical Support for more information.*

Click “**Protocol Reagent Manager**” to open the **Protocols and Reagents Manager** utility. Login with the User ID (default): *Supervisor* and Password (default): *Supervisor*.

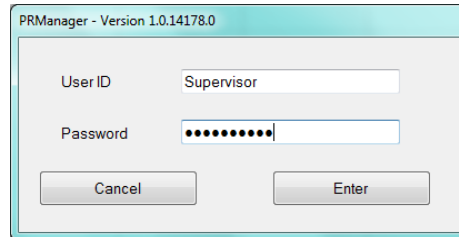

Figure 74

Click “**Browse**” in the field for **Import File** and select an export package (compressed zip folder).

*Tip: It is advised to make a backup copy of the data before making upgrades to the SW or protocols. Please contact Technical Support for assistance.*

The new protocol(s)/template(s)/special protocol(s) to be imported are listed under **Import Protocols**.  
The associated reagent(s) to be imported are listed under **Import Reagents**.  
The associated negative control link(s) to be imported are listed under **Import Negative Control**.

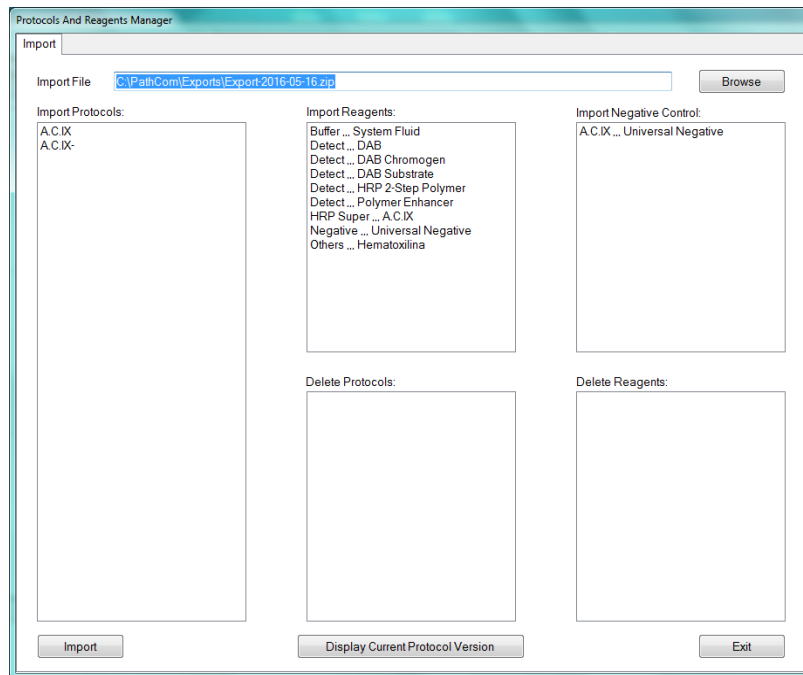

Figure 75

Note: The manufacturer may use the export function to remove obsolete protocols and discontinued products. The protocols to be deleted are listed under **Protocols to Delete**.  
The reagents to be deleted are listed under **Reagents to Delete**.

Click **“Import”** to import the contents of the export package. A status bar will be displayed to show the progress of the import process.

All new protocols, templates and reagents will be added to the system.

**⚠ All existing protocols that share the same name as an imported protocol will be overwritten.**

**⚠ All existing templates/special protocols that share the same name or index position as an imported template/special protocol will be overwritten.**

**⚠ All existing reagents that share the same name as an imported reagent will be overwritten.**

The system will provide a list of protocols and templates that will be overwritten. Click **“OK”** to continue or **“Cancel”** to abort the import process.

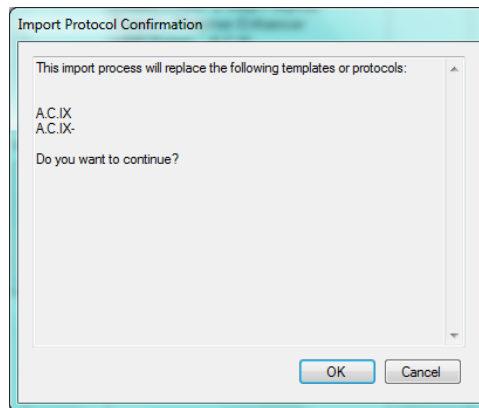

Figure 76

**⚠** After the system has imported a new protocol, the system will automatically refresh all protocols. **Save all customizations before performing an import, otherwise, some recent protocol modifications may be lost.**

Note: Protocols cannot be transferred between different protocol versions. The protocol import process will abort if the current protocol version number does not match the version number of the export package. Please update to the latest protocol version before importing a new protocol package.

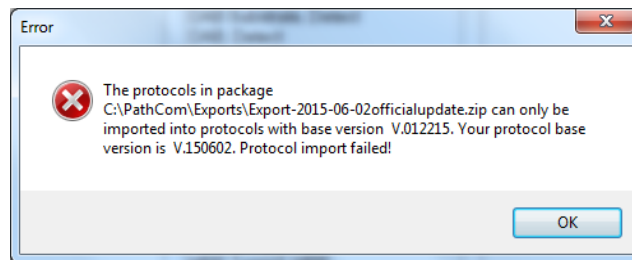

Figure 77

Click **“Display Current Protocol Version”** to view the current protocol version number. The version number will automatically update after importing a manufacturer’s protocol update.

**⚠ The manufacturer’s protocol updates must be imported in sequential order. The current protocols must be up to date before installing the next manufacturer’s release.**

Click **“Exit”** to close the utility.

## Assigning Negative Controls

All protocols (except Special) are automatically generated with a corresponding negative control protocol. All steps of the protocols are identical except the primary reagent which is substituted with the negative control reagent. The negative control is set to **Universal Negative** by default.

Click “**Negative Control Editor**” to manage and assign negative controls for each protocol.

Note: Add new negative control reagents in the Reagent Editor, under reagent type Negative.

Refer to *Reagent Editor*, p. 59 for more information on adding new reagents.

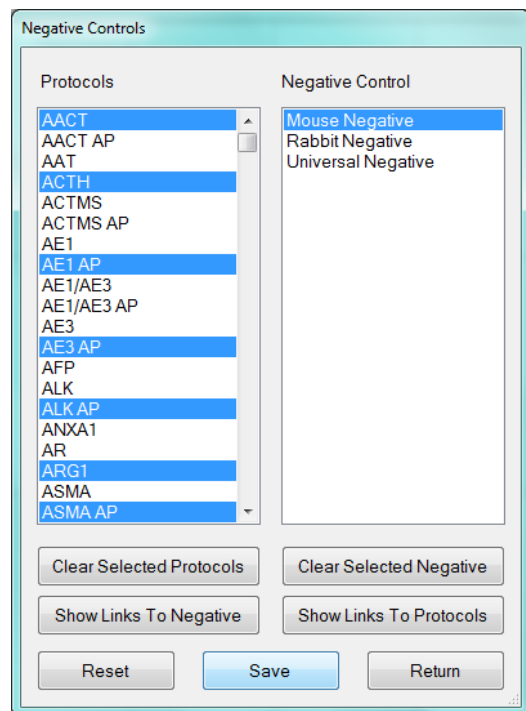

Figure 78

**To view all protocols assigned to a negative control**, select the negative control from the list and click “**Show Links to Protocols**”. All protocols linked to the negative control will be highlighted under the **Protocols** list.

Click “**Clear Selected Protocols**” to clear the protocol selection(s) displayed on the screen.

**To view the negative control assigned to a protocol**, select the protocol from the list and click “**Show Links to Negative**”. The negative control linked to the protocol will be highlighted under the **Negative Control** list.

Click “**Clear Selected Negative**” to clear the negative control selection displayed on the screen.

**To assign a negative control to a protocol**, select the protocol(s) listed under **Protocols** and select a negative control reagent listed under **Negative Control**.

Tip: Hold down the Ctrl key to select multiple protocols.

**To change the negative control assignment of the protocol**, select the protocol(s) listed under **Protocols** and select a different negative control reagent.

Note: The user cannot remove a negative control assignment. They may only change it, as a negative control must always be selected

Click “**Save**” to link the selected protocol(s) to the negative control.

Click “**Reset**” to reset all assignments back to the default negative control, Universal Negative.

## Adding Reagents and Protocols in the Reagent Editor

The user has the option to use third-party antibody products on the system. This may be necessary when certain antibodies are not offered in the Oncore Pro product line.

Click “**Reagent Editor**” to view and manage the system’s reagents and protocols. New antibodies are added in the Reagent Editor to generate new protocols in the Protocol Editor. These antibodies are listed by the Reagent Type corresponding to the detection system type in the Protocol Editor.

To add a new protocol and its antibody, select the **Reagent Type** from the list and click “**Add New**”.

Input the name of the antibody in the **Name** field.

 **Each unique antibody product must have a unique name i.e.: different clone #, manufacturers, dilutions etc.**

The **Protocol Name** is automatically set to the antibody name by default.

Modify the Protocol Name in the field provided, if needed.

 **To avoid conflicts with positive or negative controls in the programming software, please refrain from using the symbols “+” and “-” at the end of the protocol name.**

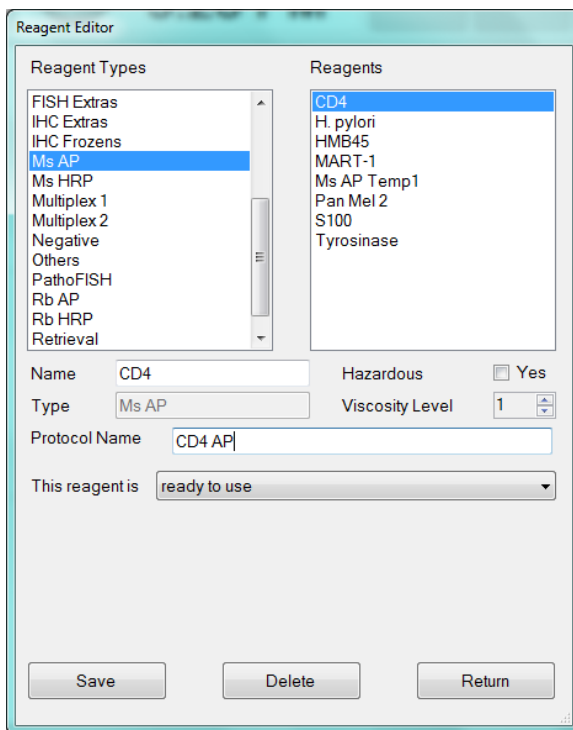

Figure 79

The option “**This reagent is ready to use**” is set by default. This field stores the mixing parameters of the reagent.

The **Viscosity Level** is automatically set by default for all antibodies. This field determines the liquid handling parameters of the reagent.

Check the box **Hazardous** to designate the reagent as hazardous, if needed. All hazardous waste will be dispensed in the designated hazardous waste station.

Click “**Save**” to add the new reagent and its protocol to the system. The new protocol will be automatically generated in the Protocol Editor and listed under the tab corresponding to the selected Reagent Type.

Note: Third party vendors’ antibodies added to the system will automatically generate a generic default protocol based on the assigned template. The user must modify the protocol for third party antibodies based on the vendor’s datasheet and protocol recommendations.

The system permits one protocol per antibody product for each detection system type. Therefore, if the reagent is run with multiple detection systems, it may only be added once to each applicable Reagent Type.

 Each protocol must have a unique name. It is recommended to append a short suffix to the end of the protocol name to identify the detection system used.

To remove an existing protocol and its antibody, select the antibody from the list and click “Delete”. The reagent will be removed from the selected Reagent Type in the Reagent Editor and the protocol will be deleted in the Protocol Editor. Alternatively, the user may delete the protocol directly in the Protocol Editor.

Note: The user may not delete the manufacturer’s pre-installed reagents and protocols.

Click “Return” to exit the Reagent Editor.

To add test protocols for antibody titrations, add the titers as new reagents in the Reagent Editor.

Manually prepare the antibody titrations in 7mL vials. Refer to p.28, Reagent Vialing Specifications, for more information.

Select the Reagent Type (AP, AP Plus, HRP or HRP Plus), and input the Name i.e.: AACT 1:100, AACT 1:200, etc.

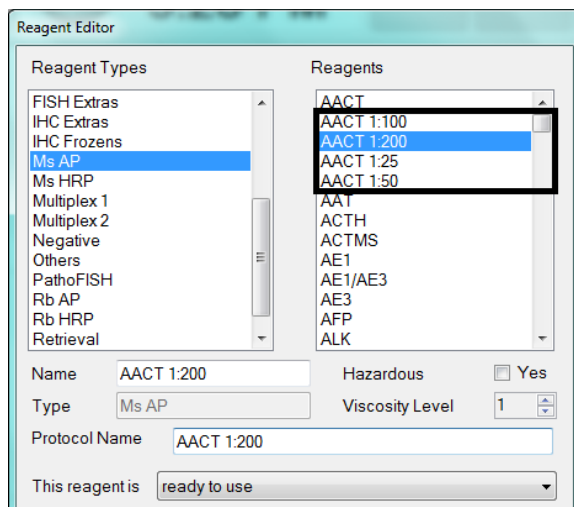

Figure 80

A new protocol will automatically be generated for each Ab titer after it is added.

View and modify the protocols as needed in the Protocol Editor.

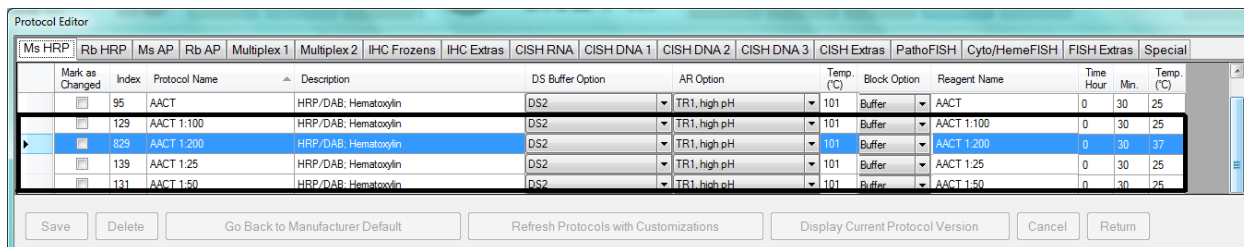

Figure 81

Delete the Ab titers from the Reagent Editor or Protocol Editor after determining the optimal antibody dilution.

### Preparing RFID Reagent Tags with the RFID Tag Editor

The Oncore Pro system offers user-programmable vials for use with the user's custom reagents and third-party antibodies. Each programmable vial contains an RFID tag which will store all the information associated with that reagent. The RFID tag may be reprogrammed for multiple uses, if needed.

Load the removable vial holder into bottom right corner of the reagent rack and then load the rack onto the instrument.

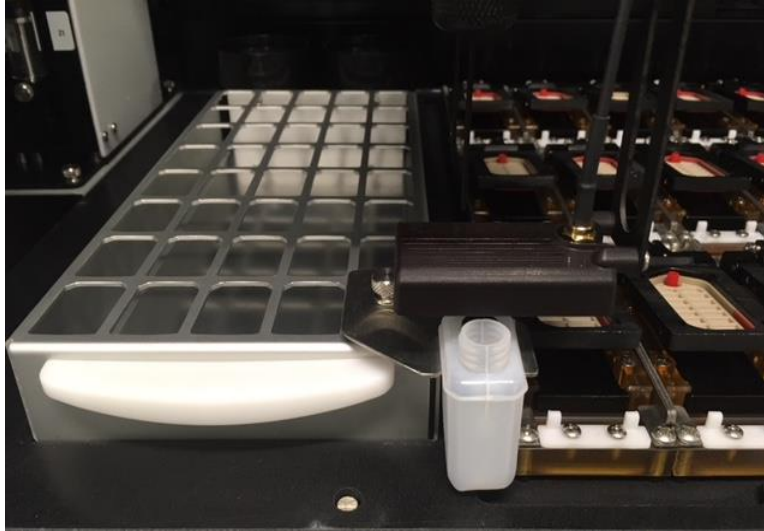

Close the door and click "RFID Editor" to launch the **RFID Tag Editor**. The robotic arm will position the RFID antenna over the vial holder. Place a user-programmable vial in the vial holder and remove the cap.

Field	Value
Tag ID	E0236005029E47E8
Reagent Type	Rb AP
Reagent Name	AE1/AE3
Bottle Type	7 ml
Number Of Tests Left	50
Lot Number	123456
Expiration Code (yyyymm)	202012
Storage Temperature (°C)	4
Manufacturer Name	---Add or Remove---
Catalog Number	A1

Figure 82

**To read the information in the RFID tag**, click **“Read Tag”**. The programmed information will be displayed in the empty fields to the left.

*Note: Brand new RFID tags will not be read correctly, as they only contain a randomly generated Tag ID.*

**To write information into the RFID tag**, complete the entry fields to the right and click **“Write Tag”**.

Select the **Reagent Type** and **Reagent Name** from the dropdown lists.

*Note: The user may only select user-added reagents.*

*Some reagents may not appear on the user-programmable reagent list.*

Select the appropriate **Bottle Type** (15 or 7 mL).

The bottle type is required to ensure accurate liquid detection and number of tests.

Enter the **Storage Temperature**.

Enter the **Number of Tests Left**.

15 ml vials should be tagged as 60 tests. 7 ml vials should be tagged as 30 tests.

Vials must be filled properly to the line indicated.

*Note1: The system may permit the user to reuse/reprogram user-programmed vials.*

*Please ensure vials are thoroughly cleaned and dried before re-use.*

*Note2: The system may block access for reprogramming reagent kit vials.*

Enter the **Lot Number (up to 12 characters)** and **Expiration Code (yyymm)**.

(Optional) Select the **Manufacturer Name**.

*Note: Select “---Add or Remove---”, from the dropdown menu to add a new reagent manufacturer name.*

Enter the **Catalog Number**.

The system will immediately read the tag after writing to verify and display the data in the left field.



**Do not remove the vial until the tag ID on the left is highlighted in green to indicate that the tag has been read successfully.**

*Note: The system will give a warning if the user chooses to re-use a programmed vial.*

## Creating Custom Groups

Click “**Custom Group Editor**” to edit/create custom lists of protocols for quick access to protocols in the **Barcode Label Editor**. Refer to *Add New Labels in the Barcode Label Editor* p. 19 for more information.

Select a custom group from the dropdown list **Custom Group Name**. Protocols in the custom group will be listed under Selected Protocols.

To add a custom group, click “**Add New Custom Group**”, enter a new name, and click “**Add**”.

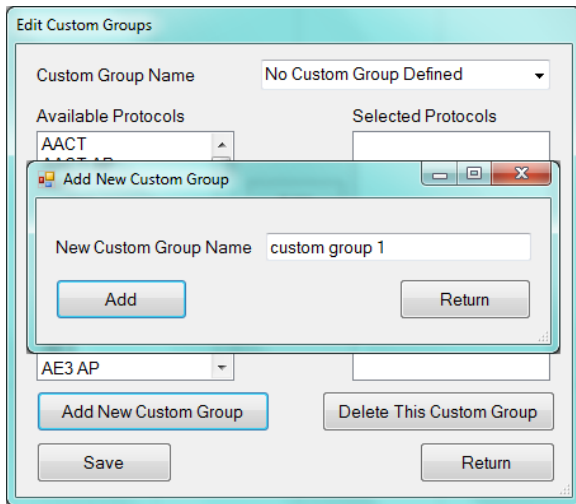

Figure 83

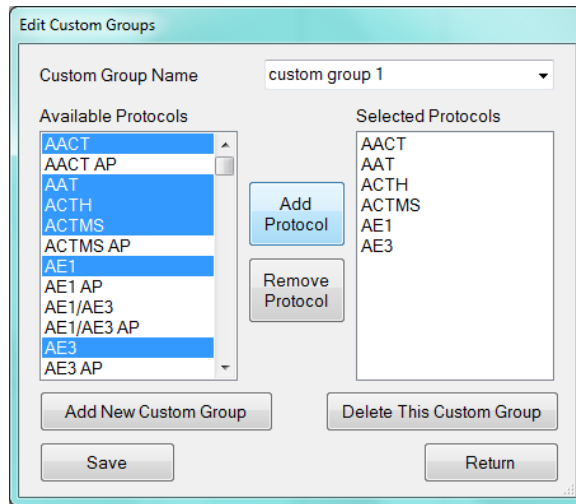

Figure 84

To add protocol(s) to a custom group, select the protocol(s) listed under Available Protocols, click “**Add Protocol**” and click “**Save**”.

To remove protocol(s) from a custom group, select the protocol(s) listed under Selected Protocols, click “**Remove Protocol**” and click “**Save**”.

To delete a custom group, select the group from the dropdown list Custom Group Name and click “**Delete This Custom Group**”.



## Creating Custom Panels

Click **“Panel Editor”** to edit/create custom panels of protocols accessible in the **Barcode Label Editor**. Refer to **Add New Labels in the Barcode Label Editor p. 19**.

Select a panel from the dropdown list **Panel Name**. Protocols in the panel will be listed under Selected Protocols.

To add a new panel, click **“Add New Panel”**, enter a new name, and click **“Add”**.

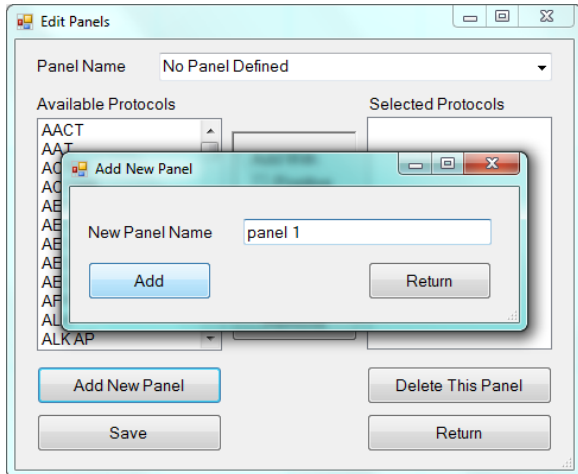

Figure 85

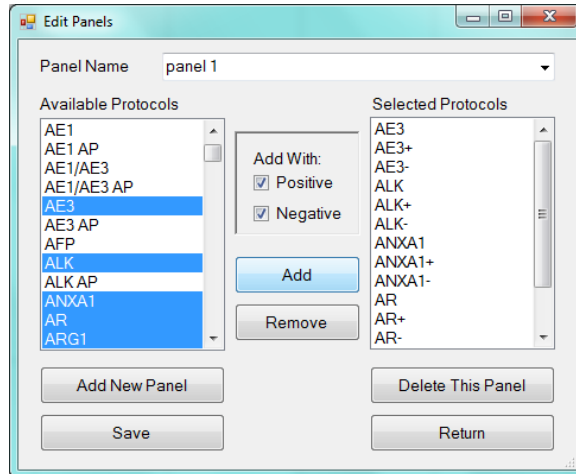

Figure 86

To add protocol(s) to a panel, select the protocol(s) listed under **Available Protocols**, click **“Add Protocol”** and click **“Save”**. The user is able to include a positive and/or negative control with each protocol if desired.

To remove protocol(s) from a panel, select the protocol(s) listed under Selected Protocols, click **“Remove Protocol”** and click **“Save”**.

To delete a panel, select the panel from the dropdown list **Panel Name** and click **“Delete This Panel”**.

## 5.3. Security

Manage system security features under the “**Security**” tab.

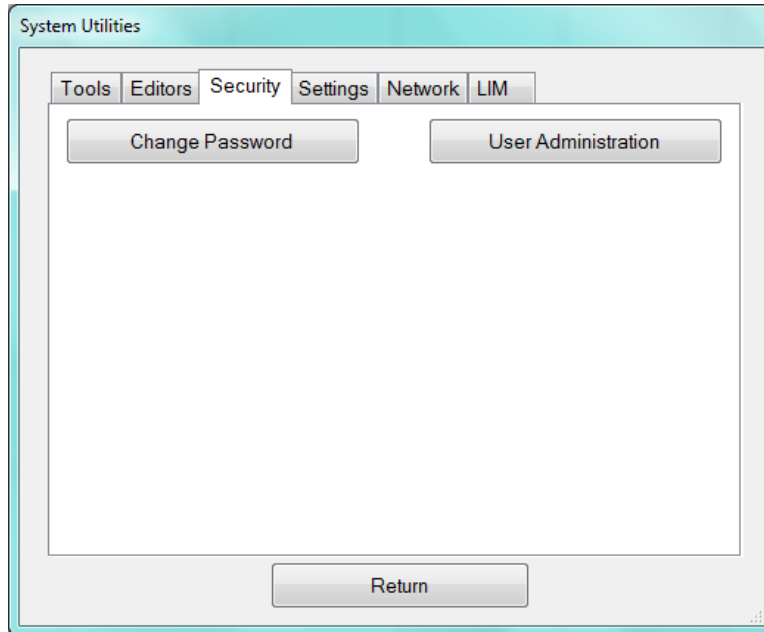

Figure 87

### Change Password

Click “**Change Password**” to change the current user login password.

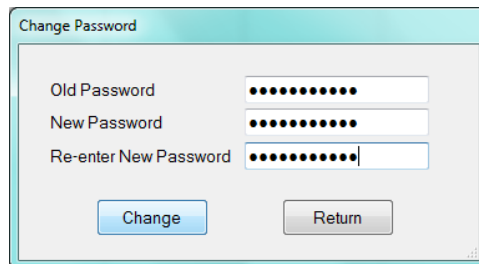

Figure 88

### User Administration

Click “**User Administration**” to view the list of users:

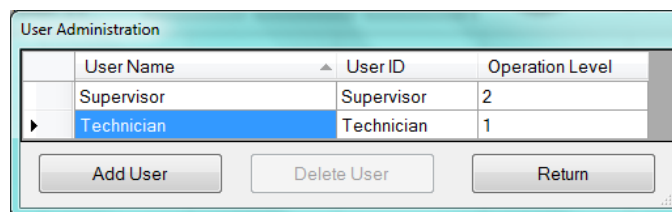
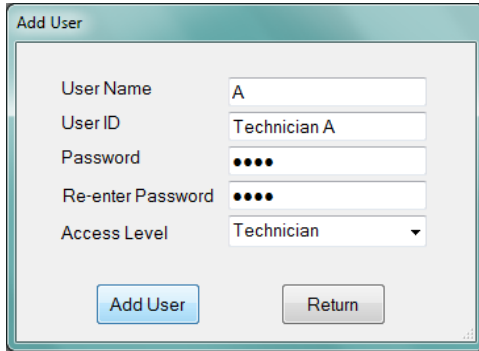

Figure 89

Users at the **Supervisor** level will have full access to Tools and Editors, and limited access to Security and Settings. Users at the **Technician** level will have limited access to Tools, Security, Settings and Editors.

To add a new user, click “Add User” to open the “Add User” window.



Enter the **Name**, **User ID** and **Password** and set the **Access Level**.

*Note: Only users with the Supervisor access level may create additional user accounts.*

Figure 90

To remove a user, select the user in the grid and click “Delete User.”

## 5.4. Settings

View system information and adjust system settings under the “Settings” tab.

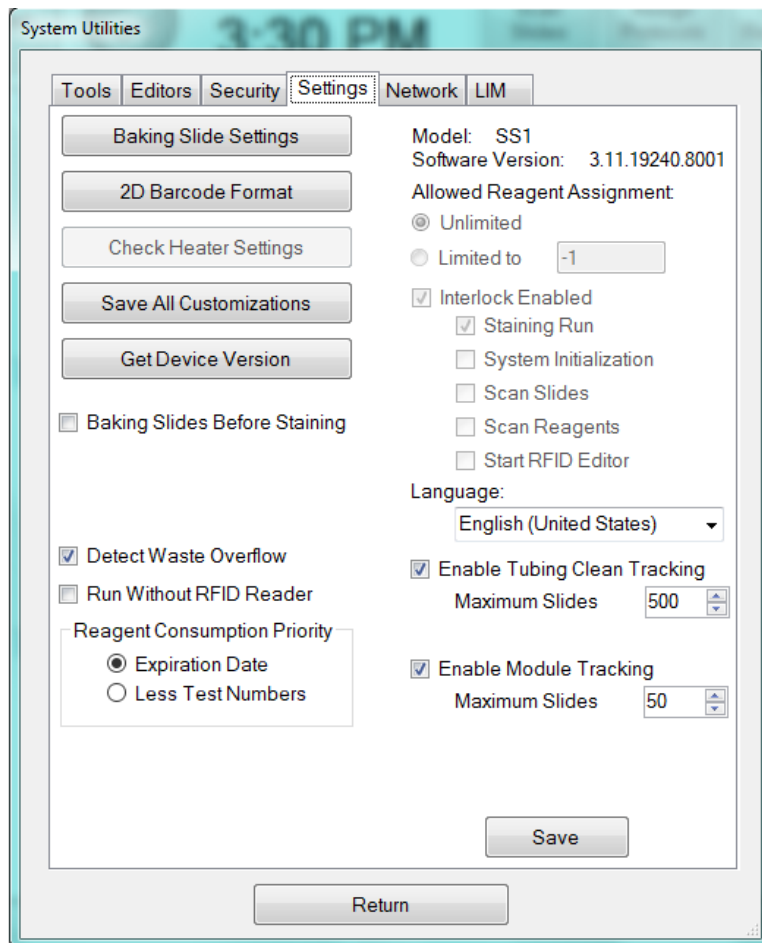

Figure 91

## Baking Slide Settings

Click “**Baking Slides Settings**” to set the Temperature (°C) and Baking Time (Minute).  
Click “**Save**” and “**Return**” when finished.

A dialog box titled "Configure Baking" with a light blue header. It contains two input fields: "Temperature (°C)" with the value "59" and "Baking Time (Minute)" with the value "60". Below the fields are two buttons: "Return" and "Save".

Figure 92

## 2D Barcode Format

Click “**2D Barcode Format**” to open the “**Barcode Label Options**” and edit settings for the Barcode Label Editor.

A dialog box titled "Barcode Label Options" with a light blue header. It contains several sections: "Date Format" with a dropdown menu showing "MM/dd/yyyy" and buttons for "MM/dd/yyyy", "MM/dd/yy", and "yyMMdd"; a legend for "d = Day", "M = Month", and "y = Year"; a list of checkboxes for "Copy Patient Information to New Record" (checked), "Show Slide UID", "Print Barcode Using Slide UID", and "Record from LIS use LIS label format"; buttons for "Label Format" and "Edit Doctor Name List"; "Label" and "Entry" sections with text input fields for "Line1" (Hospital Name) and "Line2" (Description); a "Printer" dropdown menu showing "ZDesigner GX430t"; and "Top Margin" (65), "Left Margin" (15), "Width (dots)" (252), and "Dark Level" (15) settings with spinners and buttons for "Cancel" and "OK".

Figure 93

Select the option for the **Date Format**.

Select the option to **Copy Patient ID and Protocol to New Record** to retain the patient information from the previous set of labels for the next set of labels in the Barcode Label Editor.

Select the option **Show Slide UID** (For LIS systems only) to display the unique slide ID received from the LIS system in the Slide Label Editor. This allows the user to identify slides ordered by the LIS system.

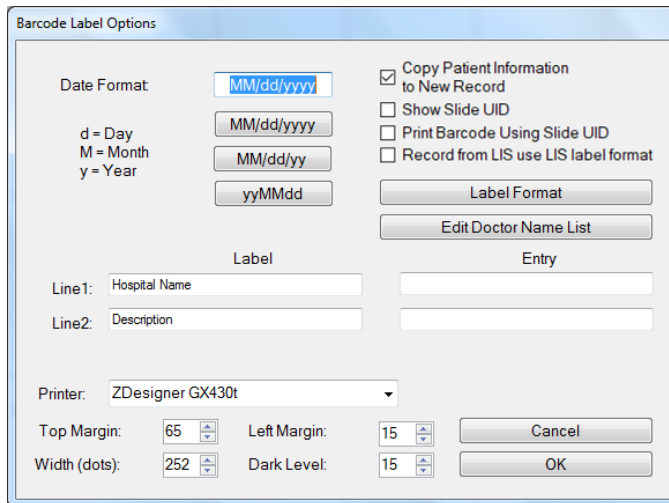
(For LIS systems only) Select the option **Print Barcode Using Slide UID** to generate the 2D barcode label using the unique slide ID received from the LIS system instead of the system-generated ID.

(For LIS systems only) Select the option Record from LIS use LIS label format to use LIS label formatting.

Enter default **Label** field names for text line 1 and text line 2 of the label.

Enter a default **Entry** in either field, if needed.

Select the **Printer** name from the dropdown list and adjust the **Margins** and print **Dark Level** as needed.



Ensure that the connected label printer is selected in the **Printer** dropdown list.

Click **“Label Format”** to open the **Label Formatter** and edit the printable data on the label. The user may change the line order on the label or select new data types to be printed on each line of the label.

*Note: Some data types are only available for use with an LIS system.*



Figure 94

Select the **Label Style** to change the layout of the label.

Select data types from the dropdown list for each line.

Click **“Save”** to save changes to the label format.

*Note: Please verify that the printed data will not overlap with the 2D barcode label.*

Click **“Edit Doctor Name List”** to add new doctors to the dropdown list in the Barcode Label Editor.

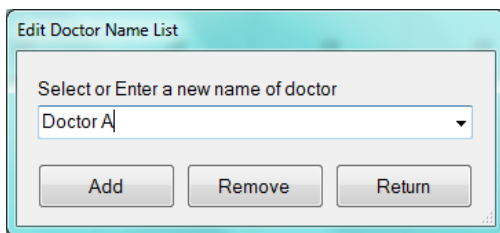

Figure 95

**To add a new doctor**, enter a new name and click **“Add”**.

**To remove an existing doctor**, select a name from the dropdown list and click **“Remove”**.

Click **“OK”** after editing the label formatting option. *The default label format is displayed below.*

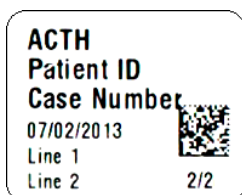



Figure 96

<b>ProtocolName</b>	
<b>PatientID</b>	
<b>CaseNum</b>	
<b>DateTimeEntry</b>	<b>2D Barcode</b>
<b>TextLine1</b>	
<b>TextLine 2</b>	<b>m/n</b>

## Save All Customizations

Click **“Save All Customizations”** to back-up the protocol customizations for every tab in the Protocol Editor.

 **The previously saved customizations will be overwritten. Therefore, the user should verify all current protocol customizations in the Protocol Editor before proceeding.**

*The user may restore protocols using the saved protocol customizations by clicking **“Refresh Protocol with Customizations”** in the Protocol Editor or **“Refresh Protocols”** in Change Protocol Template.*

## Device Version

To view the system device version information, click **“Get Device Version”**.

## Baking Slides Option

To configure slides for baking before staining, check the box **Baking Slides Before Staining** and select the amount of time allotted for cool down after baking. Click **“Save”**.

The system will now automatically begin baking slides before the start of every run.

**Baking Slides Before Staining**

After baking, slides will  
cool down

minutes.

Figure 97

## Detect Waste Overflow Option

Check the box **“Detect Waste Overflow”** to enable waste overflow detection of the wash stations. Click **“Save”**.

When the system detects overflow of a waste station, it will warn the user with a pop-up message and an alarm. If the non-hazardous waste station has overflowed, the system will divert waste to the hazardous waste station.

## Run Without RFID Reader Option

Check the box **“Run Without RFID Reader”** to disable the RFID Reader. Click **“Save”**.

This option should only be used in the event of an RFID reader failure.

## Reagent Consumption Priority

Set the usage priority when multiple vials of the same reagent are scanned during Reagent Check.

Reagent Consumption Priority

Expiration Date

Less Test Numbers

Figure 98

To prioritize consumption of reagents with an earlier expiration date (before test number), select the option: **“Expiration Date”**. Click **“Save”**.

To prioritize consumption of reagents containing fewer tests (before expiration date), select the option: **“Less Test Numbers”**. Click **“Save”**.

## Language

To change the system operating language, select the language from the **Language** dropdown list.

## Tubing Clean Tracking Option

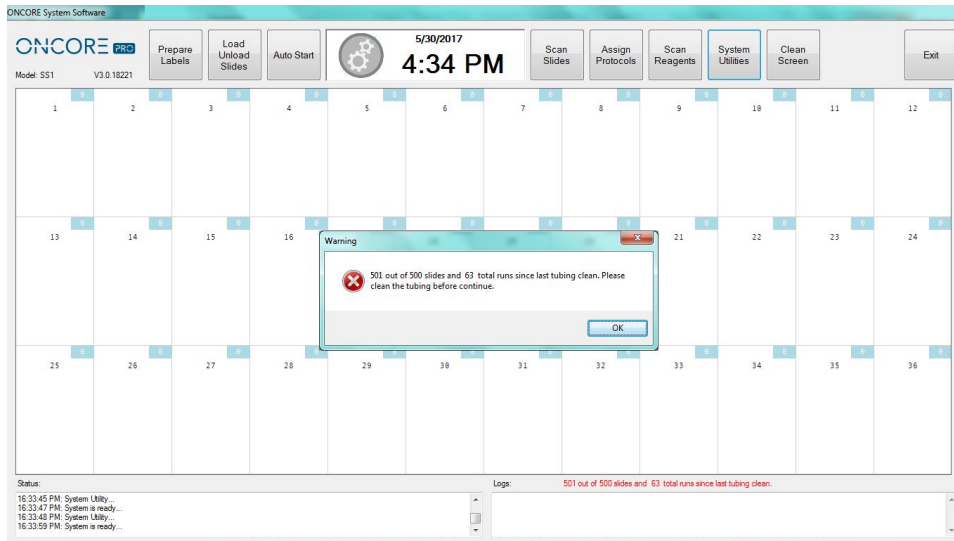

Figure 99

Check the box **Enable Tubing Clean Tracking** to track the number of slides run since the last tubing clean. Enter the Maximum Slides Run. The count is incremented after each staining run. When the system detects that the counter has exceeded the set threshold, the system will block the user from starting a new staining process until the tubing cleaning has been performed.

## Module Tracking Option

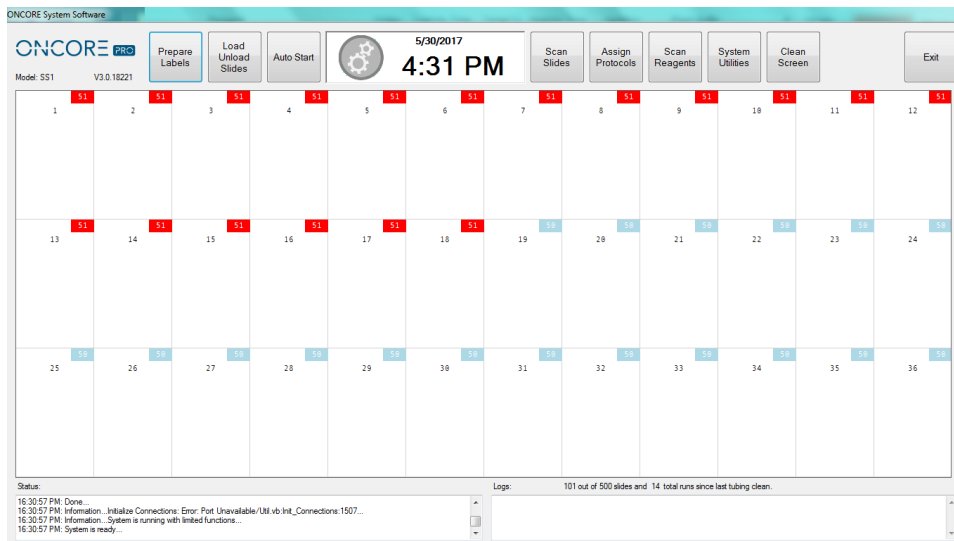

Figure 100

Check the box **Enable Module Tracking** to track the number of slides run on each module since the last reset. Enter the Maximum Slides Run. The counter for each chamber is displayed on the upper right corner of its grid on the slide map. It is incremented after each staining run. When the counter has exceeded the threshold, it will be highlighted in red to alert the user to replace the chamber(s) and reset the counter.

## 5.5. Network

Connect several Oncore Pro Autostainer systems over the local network under the “**Network**” tab.

The systems connected over the network may print from a dedicated printer on a main PC/server and share 2D barcode label records. Slides may be placed and run interchangeably on all systems connected over the network. *Contact Technical Support to setup the network and connect existing system(s) to the network.*

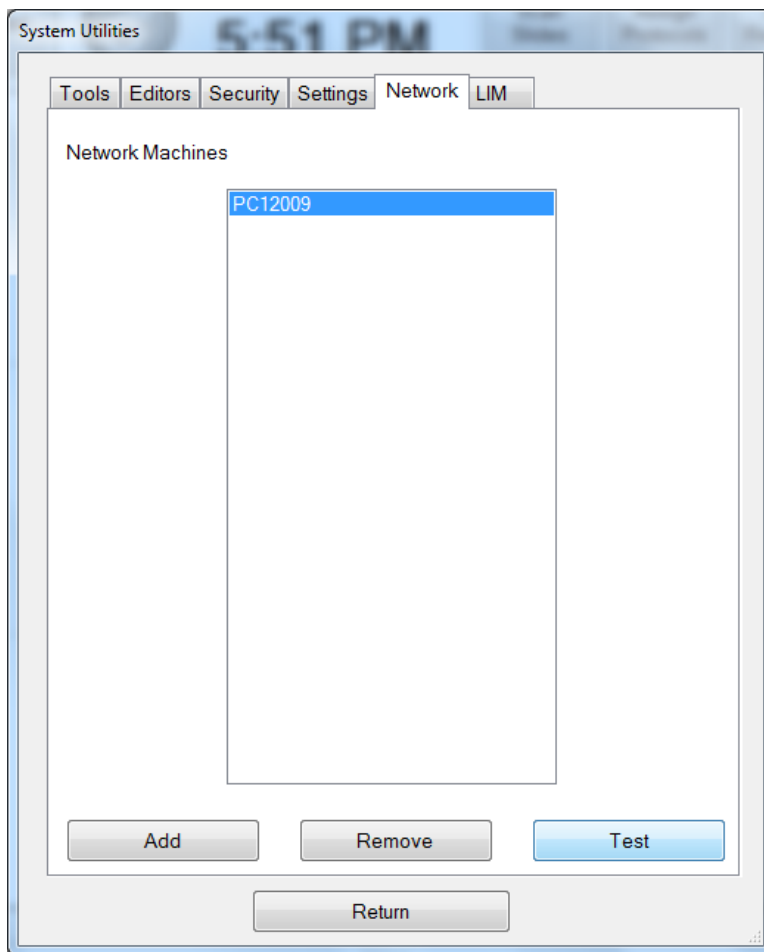

Figure 101

All system(s) connected to the current system will be listed under **Network Machines**.

**To test the connection**, click “**Test Connection**” to check if the current system is properly connected to the selected network machine/main server PC.

**⚠ To avoid unexpected errors, please ensure that all network machines are connected to the network during instrument operation.**

If the connection is not detected, check that all systems are connected to the local network. *Check settings in Windows Control Panel>Network and Internet.*

**To add a network machine**, click “Add”. The system will display a list of **Available Network Machines**.



Select the name of the network machine from the list and click “Add the selected network machine”.  
*Note: The name of the network machine is the same as the computer name.*

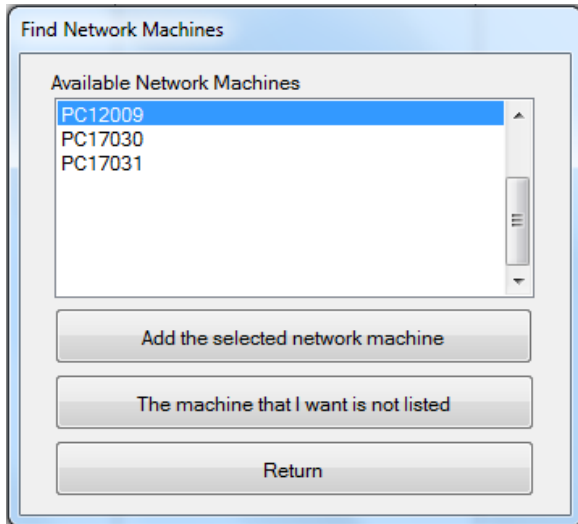

Figure 102

Alternatively, if the machine is not detected, click “The machine that I want is not listed” to manually input the name.

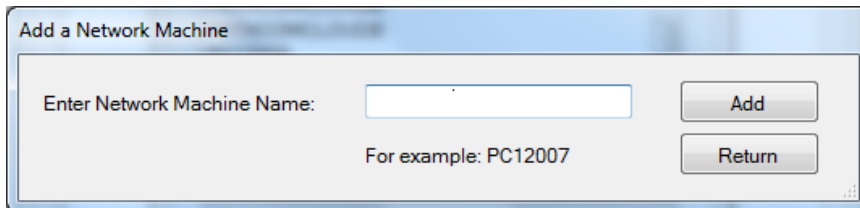

Figure 103

Click “Add” and input the User ID and Password when prompted.  
*Note: Use the computer login ID and password.*

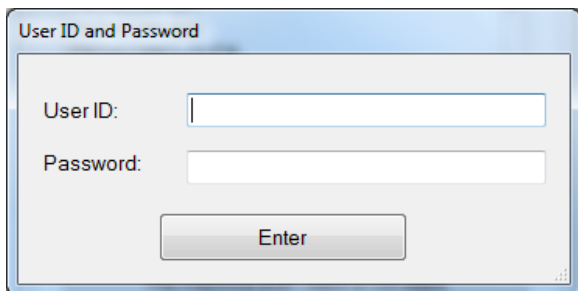

Figure 104

**To remove a network machine, click “Remove”.**

To print from a network printer, go to the “Settings” tab and click “2D Barcode Format”.

Select the shared network printer from the Printer dropdown list.  
The printer name will appear preceded by the system name on the network.

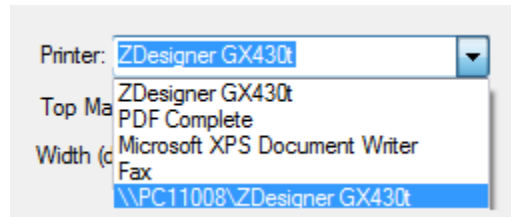

Figure 105

Change the label format options as needed.

**!** If the network printer does not appear in the dropdown list of printers, add the network printer to the system in Windows **Devices and Printers** and share the printer.

**!** **Do not share more than one printer on the network.** Uncheck any other shared printers, as they many cause unexpected errors.

*Note: If a printed label is not recognized, make sure that all systems are connected to the network, as this will ensure that the record of printed labels is up to date across all systems.*

*Note2: the label records are shared when the label is printed or moved to the printed slides.*

## 5.6. LIS/LIMS

The **Oncore Pro** system supports HL7 Server connection and MSSQL Database connection.  
*Contact Technical Support for more information regarding the setup requirements.*

## Section 6. Reports

The Oncore Pro system provides a basic report utility to track slides, run sessions, and reagent consumption. From the Main screen, click “**System Utilities**” and open the **Tools** tab to access the utility.

### 6.1. Generate a Report

Click “**Generate Reports**” to open the **Report Generator**.

#### Slide Barcode

To track a processed slide by 2D barcode, select the **Slide Barcode** option and click “**Start**”.

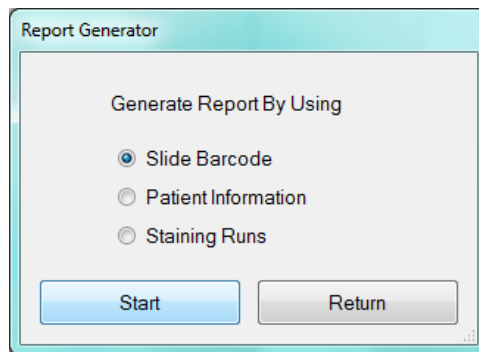

Figure 106

When prompted, place the slide in the selected position 1-36 on the instrument. The 2D barcode reader will scan the unique 2D barcode on the label and trace the slide in the data logs.



Figure 107

- A. Click “**Slide Report**” to generate the report for the scanned slide. Refer to **Report Types**, p.83, for more information.
- B. Click “**Show All Runs For This Slide**” to generate a **Run List** of all runs that include the scanned slide.  
*Note: The Run List may associate 2 or more runs with a given slide if its run process was interrupted by the continuous loading feature. Each time the instrument is stopped to load more slides, the system must generate a new run schedule and initiate a new staining process.*
- C. Click “**Return**” to return to the previous screen in order to scan a new slide or select a different option.

From the Run List, the user may choose to:

- i. Select a run by clicking the empty grid in the leftmost column (the row will be highlighted in blue). Click **"Show All Slides in Selected Run"** to generate a **Slide List** of all slides in the selected run.
- ii. Click **"Reagent Usage Report"** to generate a summary of the total reagent usage for all runs listed in the Run List.

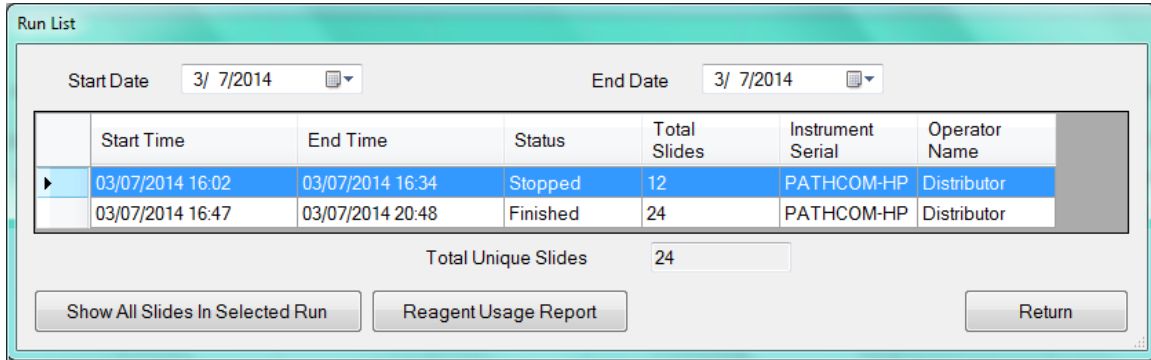

Figure 108

From the Slide List, the user may choose to:

- i. Select another slide in the same run by clicking the empty grid in the leftmost column (the row will be highlighted in blue). Click **"Slide Report"** to generate the report for the selected slide. Refer to **Report Types, p.83**, for more information.
- ii. Click **"Slide Summary Report"** to generate the report for summary of the slides in the run. Refer to **Report Types, p.83**, for more information.
- iii. Click **"Reagent Usage in Run Report"** to generate the report for reagent usage in the run. Refer to **Report Types, p.83**, for more information.

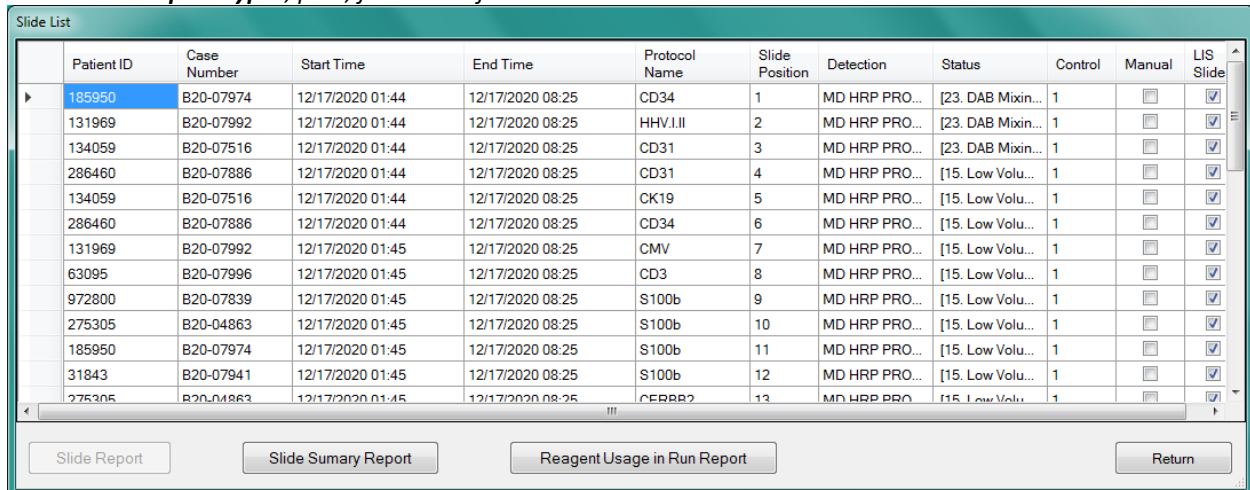

Figure 109

Note: To obtain a report from a manually assigned slide, select the **Staining Runs** option. Refer to p. 78 for details.

## Patient Information

To manually track a processed slide by patient information, select the **Patient Information** option and click “**Start**”.

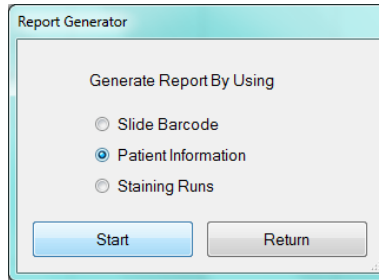

Figure 110

The system will display all processed slides in the **Patient Information** list. Search the list by entering the Patient ID in the search box, **Search Patient ID**. Sort the list by any column by clicking the column header.

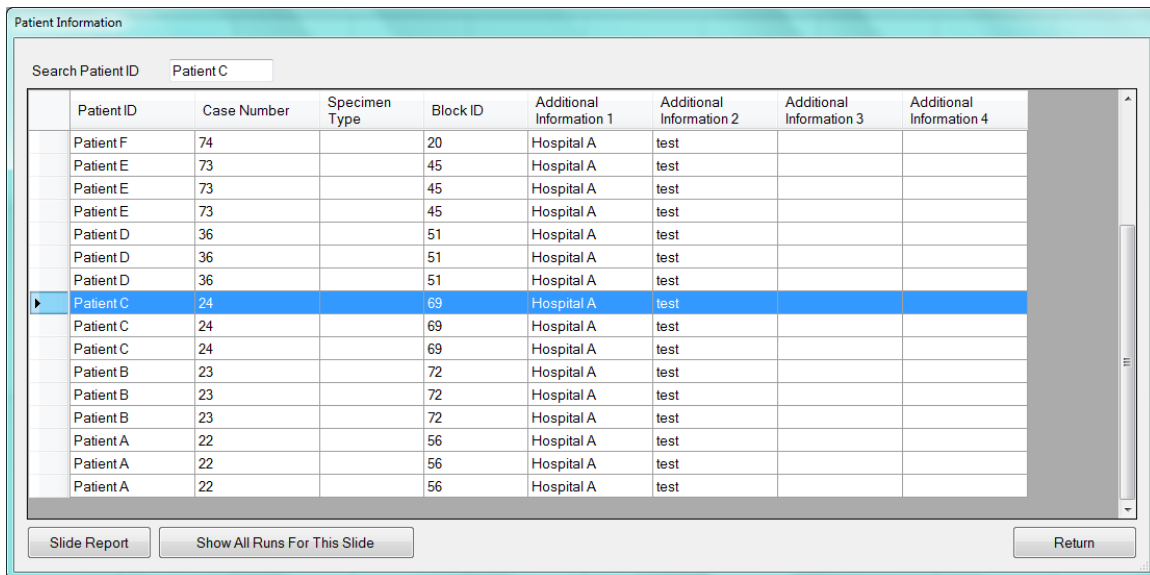

Figure 111

From the Patient Information list, the user may choose to:

- i. Select a slide by clicking the empty grid in the leftmost column (the row will be highlighted in blue). Click “**Slide Report**” to generate the report for the selected slide.
- ii. Select a slide by clicking the empty grid in the leftmost column (the row will be highlighted in blue). Click “**Show All Runs For This Slide**” to generate a Run List of all runs that include the selected slide.

## 6.2. Report Types

### Slide Report

The Slide Report provides the run summary for an individual slide. The report can be generated by scanning a slide using the Slide Barcode Option or by selecting a slide from a Slide List or Patient Information list.

Slide Report						
10/28/2013 9:43:33 AM						
Instrument	Operator	Run ID	Slide ID			
PC13012	Supervisor	3dVIPkRjt0edY1ydR_VkkQ	p5wG6E6600CZr6t8uO_aNw			
Patient ID	Case Number	Block ID	Specimen	Additional Informaton 1	Additional Information 2	
Patient A	124	988	tissue	Menarini	test8	
Protocol Name	Detection	Position	Ctrl*	LIS	Start	End
AACT	HRP/DAB; Hematoxylin	12	1	N	10/25/2013 5:48:28 PM	10/25/2013 8:38:21 PM
Status						
[15. Insufficient HRP Polymer] Warning: Low Vol Found (Reag #1, HRP Polymer): Aspirating from the bottom of vial for slides 35 27 12 [Finished]						
Reagent Name	Time (hh:mm:ss)	Temperature(C°)	Volume (ul)	Lot Number	Catalog Number	Expiry Date
DS1a	0:06:00	65	130	111111	Manually Assigned	2013-10
DS1b	0:06:00	62	130	123456		2020-12
DS2	0:06:00	40	130	123456		2020-12
TR1, high pH	0:32:00	101	370	123456		2020-12
System Fluid	0:03:45	37	130			2013-10
AACT	0:30:00	37	130	123456		2020-12
System Fluid	0:06:00	25	130			2013-10
HRP Polymer	0:12:00	25	130	123456		2020-12
System Fluid	0:06:00	32	130			2013-10
System Fluid	0:06:00	25	130			2013-10
DAB	0:06:00	25	130	123456		2020-12
Hematoxylin	0:06:00	25	130	123456		2020-12
System Fluid	0:06:00	25	130			2013-10
Ctrl*: 1, Normal slide; 2, Positive control slide; 3, Negative control slide.						

Figure 112

The first line displays the date and time that the report was generated.

The first table displays the Instrument Serial Number, Operator name, unique Run ID, and unique Slide ID.  
*Note: The slide may be associated with 2 or more unique Run IDs if its run process was interrupted by the continuous loading feature.*

Instrument	Operator	Run ID	Slide ID
PATHCOM-HP	Distributor	b8p01UIEaUCwRYUYdox3eg	ZgJ3junt.dUSm9Wimgt.Vc1w
PATHCOM-HP	Distributor	zpP-Rrn3VByNp7KQ8uc0XA	ZgJ3junt.dUSm9Wimgt.Vc1w

The second table displays the Patient ID, Case Number, Block ID, Specimen Type, Additional Information 1, and Additional Information 2.

The third table displays the Protocol Name, Detection Type, Slide Position, Control Type (normal, positive or negative), LIS(yes/no), Start Time, and End Time.

*Note: The table will display 2 or more sets of Start/End times if the run process was interrupted by the continuous loading feature.*

Protocol Name	Detection	Position	Ctrl	LIS	Start	End
AACT I36	HRP/DAB: Hematoxylin with DAB Enhancer	1	1	N	3/7/2014 4:03:08 PM	3/7/2014 4:34:36 PM
AACT I36	HRP/DAB: Hematoxylin with DAB Enhancer	1	1	N	3/7/2014 5:19:39 PM	3/7/2014 8:45:21 PM

The fourth table displays the Run Status, logging any warnings/errors that occurred during the run and the final status [Finished].

*Note: The [Stopped] status indicates that the run process was interrupted by the continuous loading feature.*

Status
[Stopped] Slide staining process has been stopped
[Finished]

The fifth table displays a summary of the protocol steps performed (Reagent Name, Incubation Time and Temperature, Volume) and reagents used (Lot Number, Catalog Number, Expiration Date) on the slide.

*Note: System Fluid and manually assigned reagents will display an Expiry Date using the current month by default.*

## Reagent Usage in Run Report

The Reagent Usage in Run Report provides a detailed summary of the reagents used in an individual run. The reagents used in the run can be traced back to individual reagent vials by using the Tag ID, or by batch using the Lot Number. The report can be generated from any Slide List.

Reagent Usage in Run Report								
10/28/2013 9:46:44 AM								
Instrument Serial	Operator Name	Start Time	End Time	Status	Total Slides	Run UID		
PC13012	Supervisor	10/25/2013 5:48:15 PM	10/25/2013 8:37:33 PM	Warning	3	3dVIPkRJt0edYiydR_VkkQ		
Reagent Name	Tag ID	Test Contained	Test Used	Position	Catalog Number	Lot Number	Expiry	Vendor
DS1a	FFFFFFFFFFFFFFFF	3	3	7	Manually Assigned	111111	2013-10	Unknown
DS1b	E0236005029FCEDA	100	3	2		123456	2020-12	MENARINI DIAGNOSTICS
DS2	E023600502A03C2B	100	3	3		123456	2020-12	MENARINI DIAGNOSTICS
TR1, high pH	E023697003A5EF10	36	3	4		123456	2020-12	MENARINI DIAGNOSTICS
AACT	E0236815017D17DC	5	2	14		123456	2020-12	MENARINI DIAGNOSTICS
HRP Polymer	E004028051FD2339	100	3	1		123456	2020-12	MENARINI DIAGNOSTICS
DAB	E0236815017DD616	36	3	6		123456	2020-12	MENARINI DIAGNOSTICS
Hematoxylin	E0236815017A1637	100	3	13		123456	2020-12	MENARINI DIAGNOSTICS
Universal Negative	FFFFFFFFFFFFFFFF	1	1	30	Manually Assigned	111111	2013-10	Unknown

Figure 113

The first line displays the date and time the report was generated.

The first table displays the Instrument Serial Number, the Operator Name, the Start Time and End Time, the Run Status, the Total Slides, and the unique Run ID.

The second table displays a summary of all reagents used in the run (Reagent Name, Tag ID, Test Contained, Test Used, Position, Catalog Number, Lot Number, Expiration Date, Vendor Name).



## Reagent Usage Report

The Reagent Usage Report provides an overall summary of total reagents usage for a user-specified time period. This data may be useful for ordering and tracking reagent consumption. The report can be generated from any Run List.

Reagent Usage Report	
10/28/2013 9:55:40 AM	
<b>From</b>	<b>To</b>
9/25/2013 12:00:00 AM	10/28/2013 11:59:59 PM
Reagent Name	Test Used
AACT	79
AAT	1
ACTH	6
ACTMS	2
AE1	2
AE1/AE3	2
AE3	3
AFP	2
ALK	2
ANXA1	1
AP Polymer	5
AR	2
ARG1	1
ASMA	1
BCA225	1
BCL2	1
BCL6	1
BEREP4	1
BGS	1
C3D	1
C4D	1
CA125	1
CA19-9	1
CAD17	1
CALC	1
CALD	1
CALP	1

View file in Read Mode	
CALRT	1
CD117	1
CD11e	1
CD13	1
CD14	1
CD15	1
CD16	1
CD163	1
DAB	122
DS1a	128
DS1b	127
DS2	127
Hematoxylin	55
Hematoxylin E	72
HRP 2-Step Polymer	1
HRP Polymer	123
Polymer Enhancer	1
Red Chromogen	5
Red Substrate	5
TR1, High pH	127
Universal Negative	2
Volume	1
<b>Total</b>	<b>1026</b>

Figure 114

The first line displays the date and time the report was generated.

The first table displays the user-specified time period used to generate the list.

*Note: The report can also be generated using a Run List for an individual slide.*

The second table displays a list of all reagents and the number of tests used for each. The last line of the table displays the total number of tests used in the user-specified time period.

## Slide Summary Report

The Slide Summary Report provides an overall summary of total slides in a-specified run. The report can be generated from any Run List.

Slide Summary Report					
2/25/2021 12:15:21 PM					
Patient ID	Case Number	Protocol Name	#	Notes	Status
189950	820-07974	CD34	1	MD HRP PROTOCOL	Finished
131969	820-07992	HHV.LI	2	MD HRP PROTOCOL	Finished
134059	820-07516	CD31	3	MD HRP PROTOCOL	Finished
286460	820-07896	CD31	4	MD HRP PROTOCOL	Finished
134059	820-07516	CK19	5	MD HRP PROTOCOL	Finished
286460	820-07896	CD34	6	MD HRP PROTOCOL	Finished
131969	820-07992	CDV	7	MD HRP PROTOCOL	Finished
63095	820-07996	CD3	8	MD HRP PROTOCOL	Finished
972800	820-07839	S100b	9	MD HRP PROTOCOL	Finished
275305	820-04863	S100b	10	MD HRP PROTOCOL	Finished
189950	820-07974	S100b	11	MD HRP PROTOCOL	Finished
31843	820-07941	S100b	12	MD HRP PROTOCOL	Finished
275305	820-04863	CE9862	13	MD HRP PROTOCOL	Finished
275305	820-04863	CE9862	14	MD HRP PROTOCOL	Finished
49191	820-07627	p63	15	MD HRP PROTOCOL	Finished
54994	820-07863	p63	16	MD HRP PROTOCOL	Finished
49191	820-07627	SOX10	17	MD HRP PROTOCOL	Finished
109125	820-07948	TTF1	18	MD HRP PROTOCOL	Finished
109125	820-07948	CK20	19	MD HRP PROTOCOL	Finished
109125	820-07948	PSAP	20	MD HRP PROTOCOL	Finished
109125	820-07948	GATA3	21	MD HRP PROTOCOL	Finished
120277	820-07156	C.34bE12	22	MD HRP PROTOCOL	Finished
120277	820-07156	C.34bE12	23	MD HRP PROTOCOL	Finished
189950	820-07974	ACT_ML	24	MD HRP PROTOCOL	Finished
275305	820-04863	CALRET	25	MD HRP PROTOCOL	Finished
972800	820-07839	CALRET	26	MD HRP PROTOCOL	Finished
50881	820-07385	K67	27	MD HRP PROTOCOL	Finished
46803	820-07955	K67	28	MD HRP PROTOCOL	Finished
275305	820-04863	K67	29	MD HRP PROTOCOL	Finished
275305	820-04863	K67	30	MD HRP PROTOCOL	Finished

Slide Summary Report					
2/25/2021 12:15:21 PM					
9565	820-07907	K67	31	MD HRP PROTOCOL	Finished
275305	820-04863	R,PROG	32	MD HRP PROTOCOL	Finished
275305	820-04863	R,PROG	33	MD HRP PROTOCOL	Finished
275305	820-04863	R,ESTRO	34	MD HRP PROTOCOL	Finished
275305	820-04863	R,ESTRO	35	MD HRP PROTOCOL	Finished
31843	820-07941	MELANA	36	MD HRP PROTOCOL	Finished

## Staining Runs

To manually track a slide by the run session, select the **Staining Runs** option and click **“Start”**.

*Note: This is the only method for tracking a manually assigned slide.*

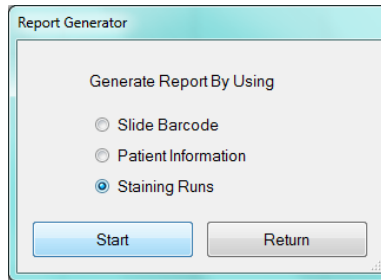

Figure 115

The system will generate a **Run List** of all run sessions. The number of **Total Unique Slides** that have been processed on the system is displayed at the bottom of the list.

Select a **Start Date** and **End Date** to display all runs in a given time period.

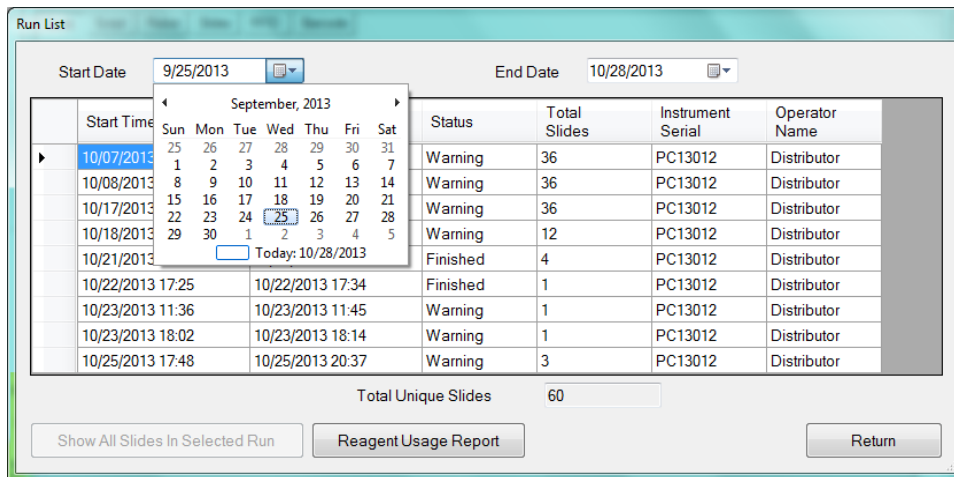

Figure 116

From the Run List, the user may choose to:



- i. Select a run by clicking the empty grid in the leftmost column (the row will be highlighted in blue). Click **“Show All Slides in Selected Run”** to generate a **Slide List** of all slides in the run.
- ii. Click **“Reagent Usage Report”** to generate a summary of the total reagent usage for all runs listed in the Run List for the selected time period.

## 6.3. Print and Save a Report

The system can generate several types of reports. Navigate each report by using the page number, arrows and search box located in the toolbar.



To print a report, click the **Print** icon  in the toolbar and select a valid network printer.

  Do not select the barcode printer.

To save a report, click the **Export** icon  in the toolbar and select the application: Excel, PDF, or Word.

## 6.4. Backup Report Data

From the Main screen, click “**System Utilities**” and open the **Tools** tab to access the utility. Click “**Backup Report Data**” to access the backup feature.

Select/Enter a date to **Backup Report Data Before** and click “**Backup**”.



Figure 117

To retain the selected data after performing the backup, select the option: “Keep selected files after backup”.

To remove the selected data after performing the backup, select the option: “Remove selected files after backup”.

Select a folder location where the backup will be saved i.e.: local disk or external flash drive. Alternatively, the user may create a new folder location by clicking “**Make New Folder**”. Click “**OK**” to proceed.

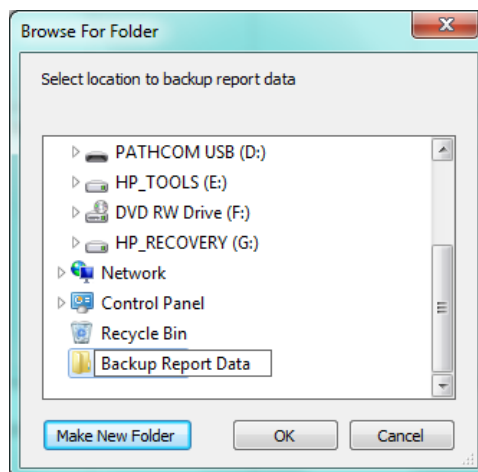

Figure 118

All report data files created before the selected date will be copied to a new folder named “**ReportDataBackup**” and the current date.

## Section 7. System Maintenance

The user should adhere to a routine preventative maintenance schedule to maximize the reliability and lifespan of the Oncore Pro Slide Stainer. *Contact Customer Service for a supply of spares and consumable items.*

### 7.1. Daily Maintenance Recommendation

#### Modules

The modules should be cleaned routinely (recommended after every run) to prevent the buildup of salt and reagent residues.

1. Unload all slides from the system.
2. Remove the chambers from the modules and set aside in DI water for cleaning later.
3. Use a soft paper towel to wipe the surface of the heater and around the inner edge of the slip holder.
4. Insert the paper towel into the hinge to absorb any excess liquid remaining after the run.
5. Use a lint-free alcohol wipe to wipe away any remaining reagent residues.

#### Chamber

The chambers should be cleaned routinely (**WEEKLY** or after every five runs) to remove staining residues that could negatively affect staining quality.

Run the chamber cleaning protocol on all 36 module positions:

1. Load the provided ONCORE Pro Chamber Cleaning Kit onto the system.
  - a. Fill two of the provided empty vials labeled "DI Water" with distilled water.
  - b. Load a "Clean 1", "Clean 2", "Clean 3" and two full "DI Water" vials onto the reagent rack. A second "Clean 3" may be needed for sufficient volume.
  - c. Remove all reagent vial caps.
  - d. Click System Utilities>Tools>"Move Arm Aside". Always move the robotic arm aside before adding or removing the reagent rack.
2. Load clean blank slides onto all 36 module positions.
  - a. Click "Load Unload Slides" to raise the lids.
  - b. Click "Slide Lids Down" to lower the lids after loading the slides.
3. Highlight all 36 module positions and click "Assign Protocols". Highlight the "Clean Chamber" protocol and click "Select".
4. Click "Scan Reagents".
5. Click "Start Staining Run". The run will take approx. 2.5 hours.
6. Once complete, remove all vials and discard the 2 "DI Water" vials and any other empty vials. Remove and discard all 36 slides.
7. Wipe chambers and clean with lint-free alcohol wipes. Wipe the edges of the chamber housing.
8. Click System Utilities>Tools>"Move Arm Aside". Gently wipe probes tips and wash stations with alcohol wipes, removing any salt build up.

#### Tubing and Pumps

(If applicable) Inspect tubing and pump syringes for leakage or a severe buildup of salt. Contact Customer Service to schedule a maintenance visit, if needed.

## 7.2. Weekly Maintenance Recommendation

### Modules and Deck Plate

The modules and deckplate should be cleaned and inspected routinely to maintain proper function.

1. Use a damp paper towel to wipe away any salt deposits that have accumulated on the module surfaces.
2. The user may pipette distilled water and/or alcohol into the hinge slot to dissolve any crystallized salt deposits.
3. The user may use a small tool such as a paper clip to remove any debris or glass fragments that are obstructing the hinge slot and preventing the slides from inserting properly.
4. Use a soft paper towel to absorb any excess liquid that has accumulated in the grooves of the deckplate.
5. (Optional) Perform a module and heater function check. This should be performed after receiving a temperature/module malfunction warning. Refer to **Check for Module Malfunction** p. 49 for more information.

### Wash Station and Z1/Z2 Probes

The waste stations and probes should be cleaned routinely to prevent salt obstructions.

1. Use a lint-free alcohol wipe to wipe away any reagent residues and salt deposits that have accumulated on the surface of the wash stations and probes.
2. Click System Utilities>Tools>"Move Arm Aside" to gain access to the wash station and probes.  
 **Take care not to bend the probes. Verify the alignment of the Z1 and Z2 probes if needed.**
3. Inspect the percolation holes on the wash station and clean with a cotton swab and alcohol if needed.

### Tubing and Pumps

The tubing and pumps should be primed with distilled water if the instrument is to be left idle for a prolonged time, such as on long weekends or holidays.

1. Push the quick disconnect release to detach the buffer container and remove it from the instrument.
2. Empty and rinse out the contents.
3. Fill the buffer container approximately 1/3 or more full with DI Water and re-connect to the tubing.
4. Click System Utilities>Tools>"Prime Z1 and Z2" to prime the pumps and tubing several times.
5. Detach the buffer container and empty the remaining contents.

## 7.3. Monthly Maintenance Recommendation

### Chambers

The chambers should be inspected routinely and replaced as needed (estimated after every 50 runs).

### Tubing

The tubing should be inspected and cleaned routinely (recommended after every 500 slides) to prevent buildup of reagent residues. An obstruction in the tubing line may cause inconsistent/negative staining results and premature wear on the pumps.

1. Ensure that the buffer container is filled and connected to the tubing.
2. Load the reagent rack with cleaning solutions for Z1 and Z2 in the designated positions.
3. Click System Utilities>Tools>"Tubing Clean" to initiate tubing clean. *Refer to **Clean Z1/Z2 Tubing**, p. 47 for more details.*



Clean tubing as frequently as needed. Visually inspect the tubing for buildup of wax deposits or DAB/Hematoxylin precipitate.

### Robotic Arm

The robotic arm should be inspected routinely to maintain proper function.

1. Click System Utilities>SP1-Z1 Calibration and SP1-Z2 Calibration to verify the alignment of the Z1 and Z2 probes.
2. Verify that the robotic arm is operating smoothly.
3. System calibration may be performed by a trained service technician if the probe becomes severely bent. Contact Customer Service for assistance.

### Computer

The C:/PathCom folder should be backed up routinely onto a flash drive/external device.

Please contact Technical Support for additional assistance.

## 7.4. Annual/Semi-Annual Maintenance

Annual/semi-annual maintenance on the whole system must be performed by a trained service technician. Contact Customer Service to schedule a maintenance visit.

A scheduled maintenance may consist of:

1. Inspection of 36 modules. Replacement of modules or parts as needed.
2. Module calibration and testing as needed. Replacement of module O-rings as needed.
3. Inspection of the robotic arm. Lubrication of the XYZ rails.
4. System calibration of the XYZ robotic arm as needed.
5. Inspection of all probes/tubing/hoses and replacement of parts as needed.
6. Inspection of pumps. Replacement or cleaning of syringes as needed.
7. Software and Firmware upgrade if applicable.
8. Running diagnostics on the system.
9. Backup and removal of logs and data files.

## Section 8. General Precautions

**Make sure the slides are placed securely on the module** – the slide should be pushed in against the spring and the spring should push the slide back under the slide clips.

**Place the reagent rack firmly in its seated position** before starting a run on the instrument.

**Remove caps from reagent vials** before starting a run on the instrument.

**Keep the door closed during operation.** The robotic arm will move unexpectedly during operation - stay clear. Do not impair the movement of the robotic arm in any way.

**Contact Customer Service prior to using reagents and solutions supplied by other vendors** on your Slide Stainer. Some solvents, acids, and other solutions may cause damage to the internal components of the Slide Stainer and affect your instrument's performance and warranty.

**Wear disposable gloves and protective lab wear when handling reagents.** Reagents are harmful and irritating to the eyes, respiratory system and skin. It may cause lung and stomach damage if ingested. SDS are available from your local sales representative or online at [biocare.net](http://biocare.net).

**Hazardous reagent wastes must be disposed of according to local, state and federal regulations.** Wear appropriate Personal Protective Equipment to prevent exposure.

**Do not multitask or run CD/DVD players on the computer while the instrument is in operation.** Multitasking is defined as running more than one software application at a time. This may lock up the instrument.

**Disable Windows Automatic Update and other background programs** while the instrument is in operation.

**Disable the Local/Wireless Internet Connection.** The system should not be connected to the Internet.

**Do not modify Windows Power options or install a screen saver.** This may cause the computer to power off unexpectedly while the instrument is in operation or may lock up the instrument.

**Do not install third party software or hardware products.** Installing third party products may lock up the instrument and may void the warranty.

**Do not make any hardware or software changes** before consulting Technical Support.

**Do not use a USB cable longer than 3 meters (10 feet).**

**Restart the computer if:**

- 1) **The USB is disconnected/reconnected.** Always connect the USB to the designated USB port.
- 2) The power supply to the instrument is powered on/off or disconnected.
- 3) The computer is put into Sleep Mode or Hibernation Mode.
- 4) The user encounters an unexpected error.

**Do not attempt to service the Oncore Pro Slide Stainer** unless instructed to do so by Technical Support. Doing so will void the warranty.

**Do not relocate the Oncore Pro Slide Stainer System to another site within your facility** before contacting Customer Service for vital information that may affect your warranty.