

## Antigen Retrieval Chamber (ARC) Manual - Research Use Only (RUO)

Digital programmable pressure system for heat-induced epitope retrieval

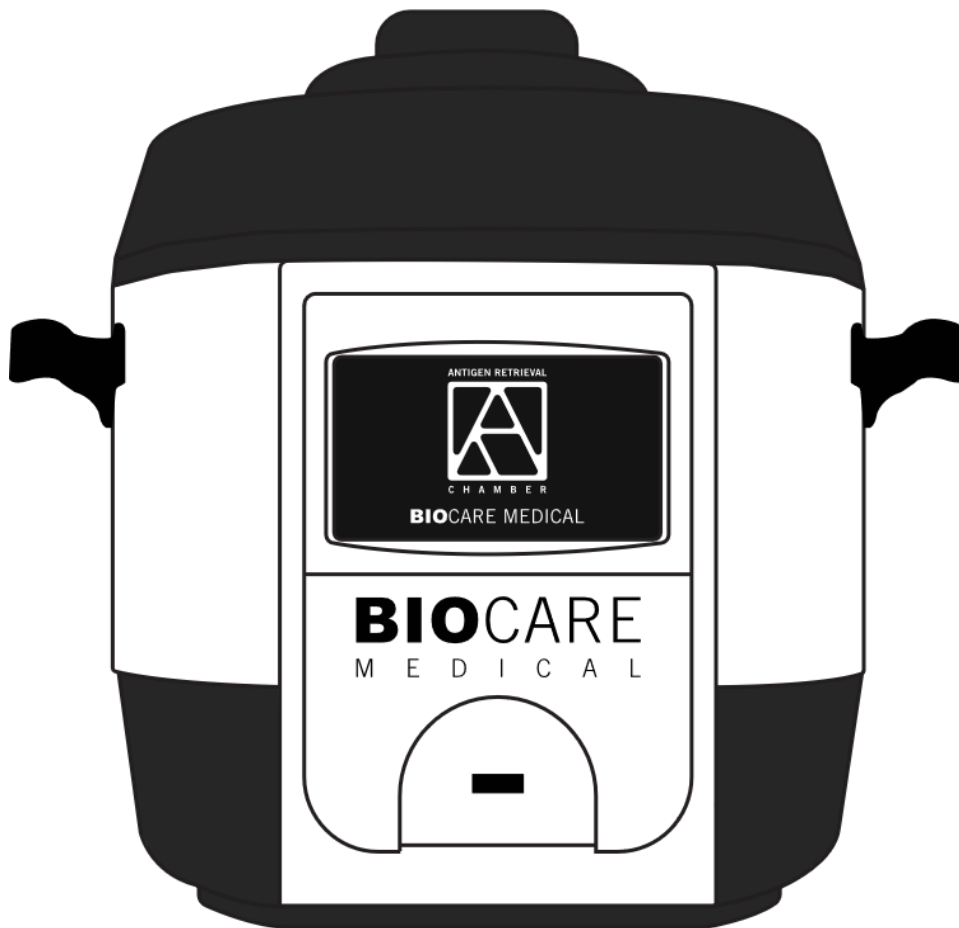



**Biocare Medical**

Technical Support:  
800-799-9499 Option 3

Customer Service:  
800-799-9499  
Fax:  
925-603-8080

Corporate Office:  
60 Berry Drive  
Pacheco CA 94553  
[www.biocare.net](http://www.biocare.net)

# Table of Contents

Table of Contents .....	3
Overview .....	4
Intended Use .....	4
For Research Use Only .....	4
Device Description .....	4
Specifications .....	4
Transportation.....	5
Storage.....	5
Handling .....	5
Environmental Conditions .....	5
Power Requirements.....	5
USB Flash Drive .....	5
Waste Disposal .....	5
Instrument Disposal .....	5
The electronic product must be sent to separate collection facilities for recovery and recycling, and in accordance with local, state, and federal regulations for electronic equipment. Prior to disposal, unplug the ARC and decontaminate with an antibacterial cleansing reagent. Follow local procedures and regulations for e-waste disposal. Contact your local technical service if you require assistance. ....	5
Accuracy .....	5
Warranty .....	6
Safety Precautions.....	6
Service .....	6
Parts & Features .....	7
Important Safeguards.....	8
Before First Use .....	9
Upon Receipt.....	9
Initial Set-Up .....	9
Instructions for Use .....	11
Operating Instructions .....	11
Control Panel Programming.....	12
Program Completion .....	15
Preheating Function.....	16
Reporting Software .....	17
USB Flash Drive .....	17
Software Reports .....	17
Reporting Software User Guide .....	17
Maintenance.....	19
Daily .....	19
Monthly.....	19
Disinfecting.....	19
Troubleshooting Guide .....	20
Quick Instruction Guides .....	21
Instrument Operation .....	21
Software Reports .....	21
Accessories and User Serviceable Parts.....	22
Consumables .....	23
Summary of Accessories, User Serviceable Parts, and Consumables.....	23
Symbol Glossary .....	24
Warning Symbol Glossary.....	24
Software Errors .....	25

# Overview

## Intended Use

For Research Use Only

The Antigen Retrieval Chamber (ARC) is for professional laboratory use in conducting heat-induced epitope retrieval (HIER) of formalin-fixed paraffin embedded (FFPE) tissue mounted on microscope slides prior to performing immunohistochemical (IHC) or in situ hybridization (ISH) staining tests.

## Device Description

The Antigen Retrieval Chamber (ARC) is a digital programmable pressure system for heat-induced epitope retrieval for professional laboratory use. The ARC offers preset temperature protocol settings as well as user programmable time and temperature settings ranging between 60°C and 121°C. The ARC transfers run data to a USB drive for export to a user's computer. The run data recorded includes the date and time per run with temperature and calculated pressure readings. The ARC has an internal memory to save the previous 100 runs. The runs can be downloaded through a USB for further processing.



Do not use the ARC for any other purpose than stated in this manual. Failure to adhere to these guidelines may result in damage to the instrument or personal injury.

## Specifications

Model	ARC	
Power Requirements	115VAC $\pm$ 10%, 1100W, 60 Hz * Suitable for use in 100VAC countries with a step-up Transformer with voltage output equivalent to the requirement above with a frequency of 50 Hz or 60Hz. **Ensure that the selected transformer meets the electrical and safety requirements of the intended country. The transformer should have a 50% power margin, thus a 1700W transformer or higher should be selected.	
Dimensions	14.2" W x 13.0" L x 13.5" H (361 x 330 x 343 mm)  With the lid open 14.2" W x 13.0" L x 21.5" H (361 x 330 x 546 mm)	
Weight	13.2 lbs (6 kg)	
Capacity	72 total standard slides (3 slide canisters) or 27 total double wide slides (3 slide canisters)	
Slide specifications	<b>Standard microscope slides:</b> Width: 24.2 - 25.6 mm Length: 75.0 - 76.5 mm Thickness: 0.9 - 1.2 mm	<b>Double wide microscope slides:</b> Width: 49.5 - 51.0 mm Length: 75.0 - 76.5 mm Thickness: 0.9 - 1.2 mm
Applicable Safety Standards and CE Directives for compliance	Electrical Safety IEC 61010 Electromagnetic Compatibility IEC 61326 RoHS Directive 2015/863 Low Voltage Directive (LVD) 2014/35/EU Electromagnetic Compatibility Directive (EMC) 2014/30/EU Waste Electrical and Electronic Equipment (WEEE) 2012/19/EU	

**Note: Slide Temperature accuracy of  $\pm 3^\circ\text{C}$  requires a voltage input of 110VAC to 130VAC.**

## Transportation

Shipping environment is 0-50°C (32-122°F). Do not stack. Protect from moisture. In addition to the ASTM regulation required markings, label the shipping container with shipping and storage temperatures as well as a warning to not stack and protect from moisture.

## Storage

Storage environment is 10-50°C (50-122°F), 10-80% non-condensing relative humidity. Do not stack. Protect from moisture. Not to exceed one year (12 months) in storage.

## Handling

The ARC may be safely handled, installed, and operated by one person capable of lifting 25 pounds (11.3 kg). Lift by the handles only. Do not move until the unit is completely cooled.

## Environmental Conditions

Placement	Unit must be placed indoors away from direct sunlight on a level bench-top capable of safely supporting the weight of the ARC and contents.
Standard Laboratory Conditions	15-30°C; 20-80% non-condensing relative humidity
Ventilation	Leave a minimum 4" on all vertical sides and 9" on the top side of the instrument and the wall, cabinets or other obstructions.
Recommended maximum altitude	At greater than 3000M, increase time suggestions.
Pollution degree	2
Main supply voltage fluctuations	±10%
Overvoltage category	Category II

**Note: Slide Temperature accuracy of ±3°C requires a voltage input of 110VAC to 130VAC.**

## Power Requirements

The ARC must be plugged into a properly grounded power outlet. ARC models in other than 115 VAC environments must be connected to a transformer that provides the required power (115VAC ± 10%, 1100W, 60Hz) to the instrument.

Do not defeat grounding provisions by bypassing the grounding pin or the power cord.

**Please Note: Slide Temperature accuracy of ±3°C requires a voltage input of 110VAC to 130VAC. Surge protection is highly recommended for the ARC. Biocare is not liable for any damage to an ARC caused by a power surge.**

## USB Flash Drive

The ARC is equipped with internal memory to store run data. A USB 2.0 formatted to FAT/FAT32 file system with a minimum capacity of 512 MB and a maximum capacity of 16 GB is required.

## Waste Disposal

All reagents used in the ARC must be properly disposed of in accordance with local, state, and federal regulations. Refer to the Safety Data Sheet (SDS) for a given reagent if a reagent is hazardous.

## Instrument Disposal

The electronic product must be sent to separate collection facilities for recovery and recycling, and in accordance with local, state, and federal regulations for electronic equipment. Prior to disposal, unplug the ARC and decontaminate with an antibacterial cleansing reagent. Follow local procedures and regulations for e-waste disposal. Contact your local technical service if you require assistance.

## Accuracy

Temperature readings are accurate within +/- 3°C during hold.

**Note: Slide Temperature accuracy of ±3°C requires a voltage input of 110VAC to 130VAC.**

## Warranty

The ARC warranty is for one year (12 months) from receipt of purchase and covers all parts and labor when performed solely by Biocare Medical. Warranty is invalidated if equipment is abused, damaged, or improperly maintained by the customer. The warranty is not transferable to any other party should the equipment be resold or transferred by the customer to another party. To the extent permitted by law, Biocare Medical disclaims any liability for any incidental or consequential damages related to this equipment or for any warranty related services it performs.



**WARNING: Ensure the unit is always loaded as described in section Operating Instructions, step 3 (Instrument loading). Repeatedly running the instrument without a water chamber may degrade instrument performance. When this condition is detected, the system will display an error which may become persistent depending on the frequency of occurrence. Contact Technical Support if the error becomes persistent.**

## Safety Precautions

Use of infectious samples in the ARC is limited to tissues/specimens that are specified on Biocare's product datasheets. Handle control slides and test FFPE slides as if capable of transmitting infectious agents and dispose with proper precautions. It is recommended that the specimens are handled using established good laboratory working practices. No flammable or corrosive solvents are to be used in the ARC.

Reagents must always be used according to the manufacturer's instructions and good laboratory practices. Always wear gloves, eye protection and a protective lab coat when handling any chemical solution used on the ARC. Obtain the SDS from the manufacturer for each chemical constituent. Do not use any flammable chemicals on or in the ARC.

Report any serious incidents related to this device by contacting the local Biocare representative and the applicable competent authority of the Member State or country where the user is located.

## Service

Units under warranty requiring service will be returned to Biocare Medical for depot repair services. No field repairs or firmware updates will be performed on this unit. The Serviceable Parts table displays serviceable parts with the catalog number. Call Technical Support at 1-800-799-9499 Option 3 for additional questions.

### Serviceable Parts

Name	Catalog Number
ARC Sealing Gasket Kit	ARC10146
ARC Pressure Limit Valve	ARC10144
ARC Steam Cover	ARC10164
ARC Standard Slide Carrier	ARC10161 (1 carrier) ARC10161-3PK (3 carriers)
ARC Double Wide Slide Carrier	ARC10165 (1 carrier) ARC10165-3PK (3 carriers)
ARC Standard Canister	DCA132 (1 canister) DCA132-3PK (3 canisters)
ARC Canister Basket	ARC10163
ARC Condensation Holder	ARC10139

# Parts & Features

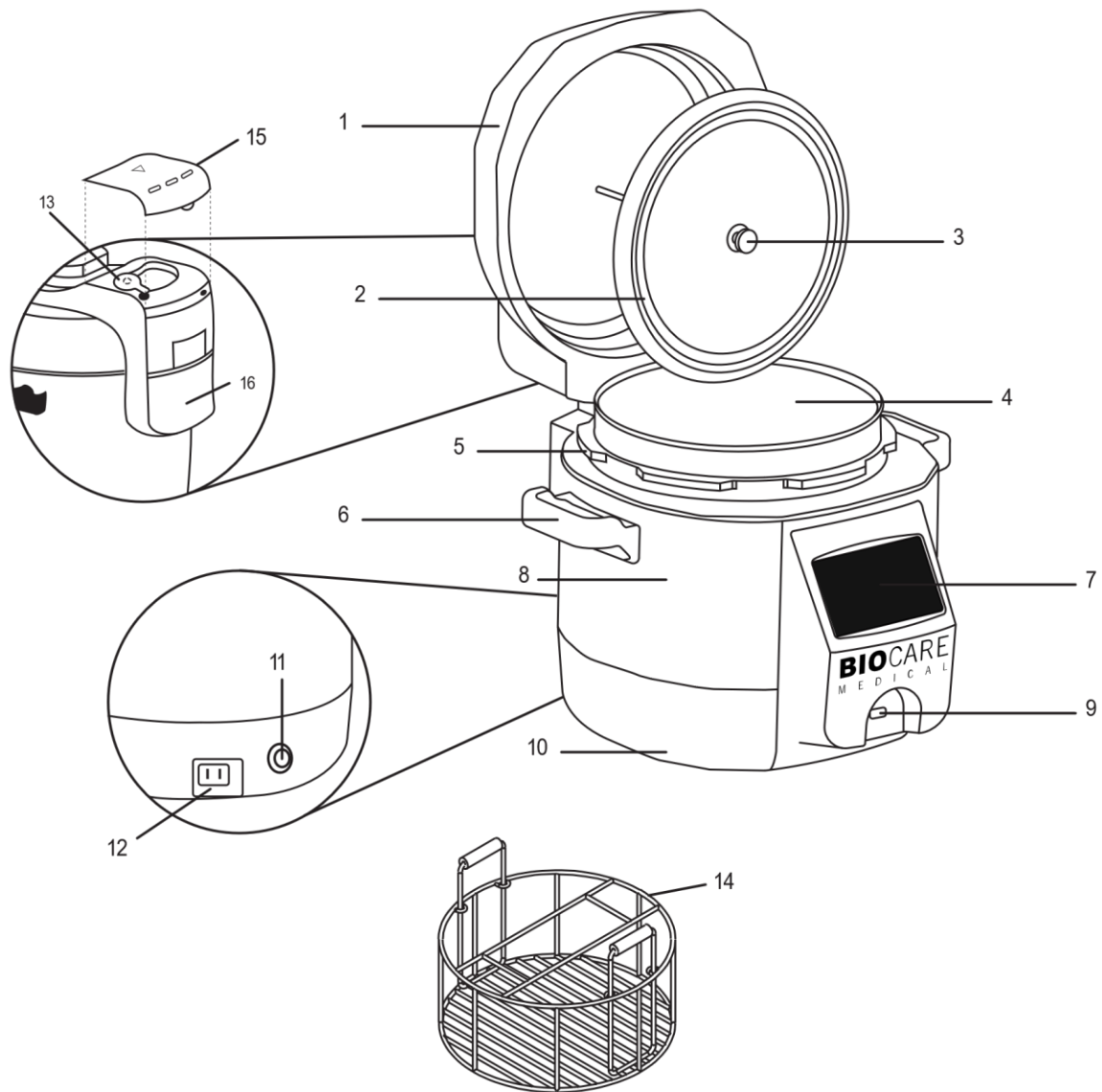

- 1. System Lid
- 2. Sealing Gasket
- 3. Rubber Grommet
- 4. Water Chamber
- 5. Upper Ring
- 6. Handle
- 7. Home Screen
- 8. Outer Body

- 9. USB Port
- 10. Base
- 11. ON/OFF Power Switch
- 12. Power Cord Socket
- 13. Pressure Limit Valve
- 14. Canister Basket
- 15. Steam Cover
- 16. Condensation Holder

# Important Safeguards

The ARC has been designed with many unique safety features. However, as when using any electrical appliance, basic safety precautions should always be followed.

1. Read all instructions before operating the unit.
2. Do not touch hot surfaces of the ARC. Use handles only.
3. Never attempt to open lid while the unit is greater than or equal to 95C.  
Do not open the ARC until the unit has cooled to below 95C and all internal pressure has been released. If the lid is difficult to rotate, this indicates that the chamber is still pressurized. Do not force it to open. Any pressure in the chamber can be hazardous.
4. Tilt the ARC lid all the way back until the end of movement. When the ARC lid is open, the lid should be tilted 90° to prevent possible injury.
5. Do not move the ARC to another position during a run. Wait until the ARC has completed a run prior to moving the instrument.
6. Do not use glass or plastic containers. The ARC has been designed using metal slide canisters for optimal heat transfer. Glass and plastic slide holders are not recommended.
7. Always check that there is deionized or filtered water in the water chamber before use. Do not run the unit when the metal water pot is empty, as this will cause the metal water pot to burn.
8. Always check the pressure release device for clogging before use. Do not operate without the pressure release properly installed.
9. Do not place the ARC in a heated oven or on any heated surface. Do not place the ARC near a flame or gas source.
10. Keep the exterior of the unit dry. To protect against electrical shock, do not immerse cord, plug or outer vessel in water or other liquids.
11. Adhere to the product voltage requirement and make sure it is compatible with the electrical voltage/frequency for the country of operation with the use of a transformer as necessary.
12. Do not let the power cord hang over the edge of table or counter or touch hot surfaces.
13. Do not use outdoors.
14. Do not use under hanging cabinets, as steam may cause damage.
15. Ensure the unit is always loaded as described in section Operating Instructions, step 3 (Instrument loading).
16. Always attach the power cord plug to appliance first, before plugging the other end into wall outlet.

**Note: Always unplug the power cord from the electrical outlet to fully disconnect power to the instrument.**



**WARNING: Never plug an ARC (115V) unit directly into a 100 VAC power source. Use a step-up transformer to power the unit. Never plug an ARC (115V) unit into a 230 VAC power source.**

17. Always close and lock the lid before executing a protocol.  
Note: to lock the lid, close the lid and turn clockwise

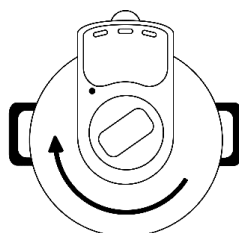



# Before First Use

## Upon Receipt

Unpacking should be performed or supervised by trained laboratory personnel or facility engineer who will record any issues with regard to missing or damaged contents. In the event the instrument was damaged in transit, do not operate and contact Biocare Medical Technical Support for instructions.

Upon receipt of the ARC, inspect the packaging and be sure all parts have been included. Save the packaging in the event that the instrument needs to be returned or relocated to another lab.

## Initial Set-Up

Before using the ARC for the first time, remove any packing material from inside the unit. Remove any dust accumulated from shipping by wiping clean with a damp cloth. Thoroughly clean the lid and the metal water chamber.

1. Place the ARC on a clean, flat surface where you intend to use it. Position the unit with easy access to the plug for emergency disconnect action in case of malfunction.
2. Place the condensation collector in the rear of the unit until it clicks into place.
3. Place the pressure limit valve firmly on the lid by placing it completely over the stem and aligning the valve notch with the lid alignment rib. Ensure that the limit valve is set level to ensure proper pressure buildup. NOTE: The pressure limit valve does not click or lock into place. Even though it will have a loose fit, it is safely secured. Once in place, re-install the steam cover, it is not necessary to remove the cover or pressure limit valve except for cleaning purposes.
- 4a. For 115VAC  $\pm$  10%, 60 Hz environments, connect the power cord to the unit & then plug the cord into a suitable grounded outlet. Turn ON/OFF switch to the ON (I) position.
- 4b. For other voltage environments, connect the power cord to the unit and then plug the cord into a transformer using one of the 120V US outlets in the front of the transformer. Plug the transformer outlet into a suitable grounded outlet. Turn the transformer using the ON/OFF button in the front of the transformer and turn the ARC ON/OFF switch to the ON (I) position.

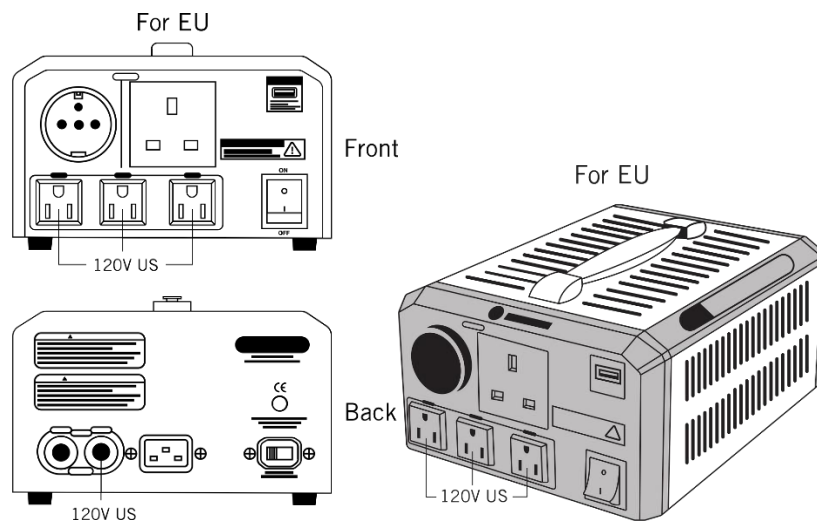

Part# ARC10180 ARC 230V Transformer

**Warning** do not plug the unit into the European style outlets , or any outlet that's not labeled with a 115V  $\pm$  10% rating.

**When using the step- up transformer, connect the power cord to the unit and then plug the cord into a transformer using one of the 117V Line outlets in the front of the transformer. Plug the transformer outlet into a suitable grounded outlet. Turn the transformer using the ON/OFF button in the back of the transformer and turn the ARC ON/OFF switch to the ON (I) position.**

## For Japan

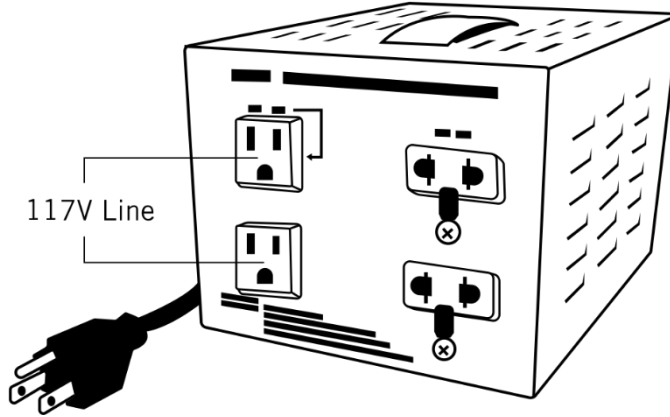

Part # ARC10181 ARC Japanese Transformer

 **Warning do not plug the unit into the Japanese style outlets , or any outlet that's not labeled with a 115V ± 10% rating.**

5. Ensure the ARC is on the Home Screen, which will display:
  - a. Current temperature of the unit
  - b. Software version
  - c. Consult manual before operating notice
  
6. Set the current date (YYYY-MM-DD).
  - a. Select the setting button on the home screen.
  - b. Select the Set Date/Time button on the Setting screen.
  - c. Use the Up/Down arrow buttons (located to the left of year) to set the current year.
  - d. Use the Up/Down arrow buttons (located to the left of month) to set the current month.
  - e. Use the Up/Down arrow buttons (located to the left of Day) to set the current day.
  
7. Set the current time (24-hour clock).
  - a. Select the Continue button on the Set Date screen.
  - b. Use the Up/Down arrow buttons (located to the left of Hour) to set the correct hour.
  - c. Use the Up/Down arrow buttons (located to the left of Minute) to set the correct Minute.
  - d. Select the Continue button on the Set Time screen to confirm the settings.
  - e. If the information is correct, select the Confirm button to save the settings.  
If changes are needed, click the back button on the top left corner of the screen.
  
5. Select the language.
  - a. Repeat step 5.
  - b. Select the setting button on the home screen.
  - c. Select the Set Language button on the Setting screen.
  - d. On the Select Language screen, select the desired language button from the options available.
  - e. On the Set Language screen select the Confirm button to change the language.
  - f. On the Set Language screen select the Home icon to cancel the language selection.

# Instructions for Use

## Operating Instructions

Once the ARC is appropriately set up, antigen retrieval can begin.

1. If not already plugged in, plug the power cord first into the ARC and then into the appropriate wall outlet or transformer (refer to Initial Set-Up 4b) Turn ON / OFF switch to the ON position (I).
2. To open the lid, grasp the handle, turn counterclockwise, and tilt the lid 90°.
3. Instrument loading

**Note: Using either water below room temperature (below 20°C) or a volume outside of 525mL ± 25 mL of deionized or filtered water may cause adverse staining results.**



**WARNING: Ensure the unit is always loaded as described in this section. Repeatedly running the instrument without a water chamber or underloaded may degrade instrument performance. When this condition is detected, the system will display an error which may become persistent depending on the frequency of occurrence. Contact Technical Support if the error becomes persistent.**

1. Add 525mL ± 25 mL of deionized or filtered water to the ARC metal water chamber. Make sure that the outside of the metal water chamber is kept completely dry and clean and there are no dents or deformations in the bottom or rim.

Note: Using either water below room temperature (below 20°C) or a volume outside of 525mL ± 25 mL of deionized or filtered water may cause adverse staining results.

2. Loading of slide carriers, metal slide canisters, and canister basket into metal water chamber:
  - a. Load slides into Slide carriers. Use the standard slide carrier for standard slides and the double wide slide holder for double wide slides.
  - b. Load slide carriers into metal slide canisters.
  - c. Fill and load Slide Canisters:
    - i. Fill each metal slide canister with 225 mL ± 25mL of either HIER solution, deionized water or filtered water.
    - ii. Place 3 metal slide canisters into the canister basket. Note: Always use 3 metal slide canisters per run.
    - iii. If there are not enough slides for 3 canisters, fill the other metal canister(s) with deionized or filtered water and run them as if slides were placed into the canister.
  - d. Place canister basket containing metal slide canisters into the water chamber.  
**NOTE: The basket is reversible, make sure to use the side that allows for 3 canisters to be inserted.**

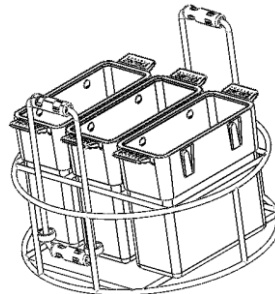

- e. For protocols above boiling point, place a dry Steam Monitor Strip on top of the metal slide canisters or canister basket.
4. Before locking the lid, make sure the sealing ring is securely in place on the sealing ring supporting cover. Hold knob on sealing ring supporting cover and press firmly over the center post of inner lid to secure (right figure below).

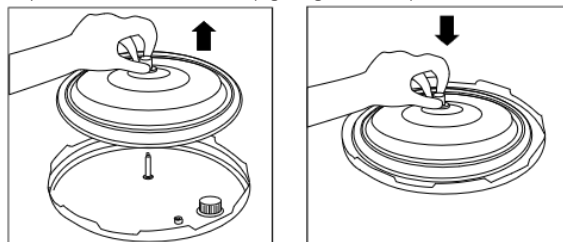

5. Lower the lid on the ARC and turn it clockwise into position.



Do not touch the steam cover or the pressure limit valve when the ARC is pressurized. Steam and hot water could escape. Ensure that the pressure limit valve is not obstructed once the lid is closed.

6. Select protocol variables as described in Control Panel Programming.

7. Ensure that none of the venting holes on the top of the unit are obstructed.

## Control Panel Programming

### 1. Starting a Protocol

#### a. Starting a Pre-Configured Protocol.

- i. Turn on the unit.
- ii. Wait for the Home Screen to be displayed
- iii. Select the Pre-Configured Protocol button
- iv. There are 6 discrete temperature set points of 60C, 80C, 90C, 95C, 110C and 118C

**Note: Altitude affects the maximum allowed protocol temperature. The ARC calculates the highest temperature allowed to accurately control operation at any operating altitude.**

- v. Select the desired protocol hold temperature by pushing the appropriate button
- vi. Select the desired protocol hold time.
  - Use the Up/Down arrow buttons (located to the left of Hour) to set the desire hours
  - Use the Up/Down arrow buttons (located to the left of Minute) to set the desire minutes
  - Use the Up/Down arrow buttons (located to the left of second) to set the desire seconds
  - Click the Confirm button to confirm the settings
- vii. Confirm that the parameters displayed on the Pre-Run Settings screen are correct
- viii. Select the Start Run button to start the run
  - **Note: The Home button can be used to cancel the run programming process**
  - **Note: The Back button can be used to navigate back to previous setting screens to correct parameters**

#### b. Starting a New Custom Protocol

- i. Turn on the unit
- ii. Wait for the Home Screen to be displayed
- iii. Select the Start a Custom Protocol button
- iv. Select the New Custom Protocol button
  - Use the Up/Down arrow buttons to select the desired temperature

**Note: Altitude affects the maximum allowed protocol temperature. The ARC calculates the highest temperature allowed to accurately control operation at any operating altitude.**

- v. For protocols greater than 5°C below boiling point, preheating can be enabled by checking the preheat button
- vi. Click Confirm to set the temperature and preheat option
- Use the Up/Down arrow buttons (located to the left of Hour) to set the desire hours
- Use the Up/Down arrow buttons (located to the left of Minute) to set the desire minutes
- Use the Up/Down arrow buttons (located to the left of second) to set the desire seconds
- vii. Click the Confirm button on the Set Time screen to confirm the settings
- viii. Confirm that the parameters displayed on the Pre-Run Settings screen are correct
- ix. Select the Start Run button on the Pre-Run Settings screen to start the run
  - **Note: The Home button can be used to cancel the run programming process**
  - **Note: The Back button can be used to navigate back to previous setting screens to correct parameters**

#### c. Starting a Saved Protocol

- i. Turn on the unit
- ii. Wait for the Home Screen to be displayed
- iii. Select the Start a Custom Protocol button
- iv. Select the Start Saved Protocol button
- v. Select the desired Page with the Up/Down arrow buttons
- vi. Select the desired saved protocol location/slot by tapping it
- vii. Confirm that the parameters displayed on the Pre-Run Settings screen are correct
- viii. Select the Start Run button on the Pre-Run Settings screen to start the run

**Note: Altitude affects the maximum allowed protocol temperature. The ARC calculates the highest temperature allowed to accurately control operation at any operating altitude.**

- **Note: The Home button can be used to cancel the run programming process**
- **Note: The Back button can be used to navigate back to the Select Saved Protocol screen to select a different saved protocol**

## 1. Saving a Protocol

### a. Before a Run

- i. Enter run parameters (hold temperature, hold time, preheating selection) and proceed to the Pre-Run Settings screen
- ii. Select the Save Protocol button
- iii. Observe that the Overwrite Saved Protocol screen is displayed
- iv. Select the desired Page with the Up/Down arrow buttons
- v. Select the desired save location/slot by tapping it
- vi. Confirm the parameters to be saved on the Confirm Overwrite screen, then select the Overwrite button

**Note: select the Home icon to cancel saving**

### b. After a Run

- i. Wait for the ongoing run to complete and for the Run Complete screen to be displayed
- ii. Select the Save Protocol button
- iii. Observe that the Overwrite Saved Protocol screen is displayed
- iv. Select the desired Page with the Up/Down arrow buttons
- v. Select the desired save location/slot by tapping it
- vi. Confirm the parameters to be saved on the Confirm Overwrite screen, then select the Overwrite button

- **Note: Select the Home icon to cancel saving**

**Note:** There are upper and lower maximums for each program time, please refer to the table below for details.

Program #	Temp	Recommended Time	Min Time	Max Time
6	118°C	30 seconds	1 second	30 minutes
5	110°C	15 minutes	1 second	30 minutes
4	95°C	40 minutes	1 second	2 hours
3	90°C	15 minutes	1 second	2 hours
2	80°C	1 hour	1 second	24 hours
1	60°C	12 hours	1 second	24 hours

Protocols for specific applications vary; these include, but are not limited to fixation, heat-retrieval method, incubation times, tissue section thickness, and detection kits used. Recommended incubation times and titers listed are not applicable to non-Biocare detection systems, as results may vary. Data sheet recommendations and protocols are based on use with Biocare products. It is the responsibility of the end user to determine optimal conditions.

2. When the pre-run screen is displayed, review temperature and time selections before starting the protocol by clicking the Start Run button.

- a. Ensure that there is 525 mL  $\pm$  25 mL of deionized or filtered water in the water chamber, the correct number of canisters with solution are installed based on operational instruction step 4, the lid is securely fastened, and the pressure limit valve is attached and level, the pressure limit valve is not obstructed, condensation collector installed, and the steam cover is installed.



**WARNING: Ensure the unit is always loaded as described in section Operating Instructions, step 3 (Instrument loading).**

**Repeatedly running the instrument without a water chamber may degrade instrument performance. When this condition is detected, the system will display an error which may become persistent depending on the frequency of occurrence. Contact Technical Support if the error becomes persistent.**

- b. Ensure that the correct temperature and time has been selected. If not, press the menu button (home) to return to the home screen. Start again at Step 1.
- c. Once everything has been checked, select the Start Run button to begin the protocol.

**Note:** Before starting a run, the temperature of the ARC should be at least 3°C lower than the desired set point.

## Control Panel Programming (continued)

3. The unit will now show the run screen during the protocol progress. During a run, the screen conveys several pieces of information:
  - a. At the top of the screen the run screen displays:
    - i. A graphical representation of protocol progress and slide temperature in the current run, as represented by the circle on the graph
    - ii. The estimated time to run completion, denoted with a clock/waiting symbol
  - b. In the middle of the screen the run screen displays:
    - i. Slide Temperature
    - ii. Unit current pressure in PSI

**Note: The unit will require 2 to 5 seconds to stabilize the temperature, during this time the slide temperature and current pressure can read 0°C and 0 PSI.**



- c. In the bottom of the screen the run screen displays the following:
  - i. Run Settings
  - ii. Pause button for run cancellation

**Note: During protocols over the boiling point, steam will escape from the pressure indicator poppit on the lid until the pressure is high enough to seal.**

4. If you need to cancel a run in the middle of the protocol, select the Pause button
  - a. The text on the Pause button will change to "Cancel Run"
 

**Note: The Pause button does not pause heating or unit operation**

    - i. If you do wish to cancel the run, select the Cancel Run button. You will be returned to the home screen.
    - ii. The canceled run will be recorded in the run history (and downloaded data) with a **C** appended to the **Hold Time** field.

Run History				
Date	Hold Time	Start Time	°C	psi
MM/DD	hh:mm:ssC	hh:mm:ss	TT	p.pp

- iii. If the Pause button was selected in error, do not push anything. The run will resume in 10 seconds.

## Program Completion

1. For protocols above the boiling point of water, the unit will beep at the end of hold, enter a cool-down phase, and then beep at the end of cool-down. When the run complete screen is displayed, the protocol is finished.



**For protocols above the boiling point of water, the pressure relief valve can generate a loud noise and expel steam when it activates. Stand clear of the steam cover (Cat. No. ARC10164).**

2. For protocols below the boiling point of water, the protocol will finish with the end of hold, the unit will beep and the run completed screen is displayed.

3. Press the Home button to continue.

4. The ARC will then show a Liquid Too Warm screen. This screen shows the current temperature of the water chamber.

- a. This screen will remain until the water chamber temperature reaches 80°C. A new run cannot be started while this screen is displayed.

**Note: The water chamber may be removed and the water replaced with room temperature deionized or filtered water to expedite the cool-down.**

- b. Once the water chamber reaches 80C, the home screen will appear and another run can be started.

5. Use extreme caution when opening the lid. Turn the lid clockwise and lift. Tilt the lid at a 45 angle above the water pot and shake several times. This will allow the water that has accumulated in the lid to drain. Push the lid all the way back to ensure it stays in place.

- a. Use extreme caution when opening the lid! Liquids and steam inside may be at scalding temperatures.

- b. Water will tend to accumulate under the lid. Allow the lid to drain at an angle prior to pushing the lid back.

6. Using extreme caution, remove metal rack holder with slide canisters from the water chamber by holding the plastic handles.

- a. Do not hold the metal slide canisters or Canister Basket by the metal portions as these are extremely hot!

- b. Gloves shall be used to help insulate skin from the heat.

7. Continue slide processing.

8. Let the ARC cool before removing water chamber with water. Properly discard the water.

9. If another run is to be started immediately, replace the warm water present in the water chamber and metal slide canister(s) with new room temperature deionized or filtered water.

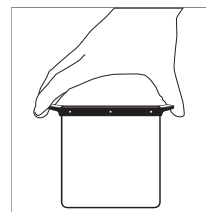
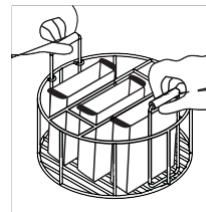

## Preheating Function

The ARC can preheat retrieval solutions when a Custom Protocol with a hold temperature min. 5°C below the boiling point is selected. The preheat functionality temporarily pauses the unit when the target (hold) temperature is reached, allowing the user to add deparaffinized slides to retrieval buffers that have already been warmed to the target temperature. This workflow modification enables better compatibility with protocols for breast tissue retrieval that previously required the use of a water bath for preheating solutions.

The unit will beep when the target temperature has been achieved – this indicates the end of the heating phase. The following message will be displayed on the unit screen:



1. Open the lid to add the required slides. Close and secure the lid. Click the Confirm button to continue with the hold phase of the protocol for the selected hold time.
2. If preheating was selected but not desired, the program will automatically continue 2 minutes after the message is initially displayed.
3. If preheating was not selected, this message will not be displayed, and the system will transition directly from the heating phase to the temperature hold phase.



# Reporting Software

## USB Flash Drive

The ARC has the ability to record and export run data to a USB drive. The data includes run ID, run date, start time, protocol temperature, protocol hold duration, and pressure. The run ID is an automatically assigned sequential number for each run performed on an ARC unit.

The ARC can be run without the USB drive present/connected. Run data will be retrievable after the run through the Data Menu by pressing the Download Reports button.

The USB Drive provided with the ARC contains reporting software that can be installed on users' computers. The ARC Reporting Software creates linear chart and summary table reports using the run data accumulated from one or more ARC systems. Please refer to the "Software Installation" file on the USB drive for installation instructions.

**Note:** It might be required to start the Installer multiple times to install all required programs.

## Software Reports

Three different types of reports can be generated with the ARC Reporting Software. The report types include:

### Chart Report

A chart report will provide a graphical representation of the recorded temperature and pressure over the run time for any selected run. This type of report may be useful for documentation of the unit's performance as well as association with any calibration or verification procedures in use by the lab.

### Summary Report by Instrument

The summary report by instrument provides a list of all runs which have been saved and imported for the selected instrument. If run data was collected from multiple ARC units, the Summary Report can be configured to list the run data from a single instrument or for all associated units at once.

### Summary Report by Date

The summary report by date generates a list of all of the runs performed between two user selected dates. If run data was collected from multiple ARC systems, run completion summaries can be provided from a single instrument or all associated units at once.

ARC run files are stored on the computer's hard drive after upload from the USB Flash Drive provided with each instrument. Therefore, ARC run files collected from multiple USB flash drives (or multiple ARC systems) can be reviewed from the same computer. Reports generated by the ARC Reporting Software may be printed directly from the software or exported to a file for future reference.

## Reporting Software User Guide

Insert a flash drive containing run data into the computer's USB port. Double-click on ARC Reports desktop icon to open the reporting software.

### Step 1: Import ARC Files

1. Click on the Import Decloaker Files button (at top right).
2. In the window that appears, click on the small "browse" [...] button adjacent to the Select Source Folder field.
3. Direct program application to appropriate folder on flash drive (e.g. SN0001).  
**NOTE: The folder will be labeled with the same serial as the unit from which data was collected. If the USB flash drive was used to collect run data from multiple ARC systems, a separate folder will exist for each unit.**
4. Click on the Import Decloaker Files button.
5. If necessary, repeat steps 2 – 4 for each additional ARC serial number.
6. Once all run data has been imported (added to 'list'), click on Close [X] button at the top of screen.

## Step 2: Generate Desired Reports

In the Generate Reports screen, select the desired report:

### Chart Report

1. Click on the Chart Report by Individual Run button.
2. Click on the Select Parameters button to open the list of uploaded Decloaker files.
3. Select the ARC serial number at the top of the screen.
4. Select desired run file from list – only one run file may be selected at a time.
5. Click on Select button to return to the Generate Reports window.
6. Click on Generate Report button.

### Summary Report by Instrument

1. Click on the Summary Report by Instrument button.
2. In the “Serial” option window, select the serial number of the desired ARC from the drop-down list. Alternatively, leave the Serial option set to “All” to generate a Summary List of all uploaded ARC run files.
3. Click on the Generate Report button.

### Summary Report by Date Range

1. Click on the Summary Report by Date Range button.
2. In the “Serial” option window, select the serial number of the desired ARC from the drop-down list. Alternatively, leave the Serial option set to “All” to generate a Summary List of all uploaded ARC run files.
3. Use the drop-down calendar in the “Start Date” and “End Date” option window to set the desired start and end dates for the date range for the report.
4. Click on the Generate Report button.

## Step 3: Print or Export Reports

All reports generated may be printed directly from the ARC Reporting Software or exported to a file for future reference.

1. To print a report, click on the printer icon button (at top left of screen), select the desired printer and then click the Print button.
2. To export a report to a file (.xls, .csv, .doc, .rtf, or .pdf), select the Export icon button at the top left of the screen.  
In the “Export Report” dialog box that appears, select the desired file type from the drop-down box of “Save as type” options.
3. Once the report has printed or exported, close the report display screen to return to the main Generate Reports window.

# Maintenance

## Daily

1. Make sure the power cord is unplugged before performing maintenance.
2. Pour the water out of the metal water chamber, rinse with deionized or filtered water and dry. Do not use harsh chemicals or scouring pads. Wipe down the outside of the metal water chamber, including the bottom. Examine the metal water chamber rim and bottom for dents or deformations. Call Biocare Technical Support to report any concerns.
3. Remove the condensation collector and empty of any accumulated water.
4. Leave the lid unlocked.
5. Do not leave liquids in the ARC when not in use.
6. Wash the metal slide canisters in soap and water. Thoroughly rinse the metal slide canisters with DI water. Do not use bleach.
7. Thoroughly rinse the slide holders with DI water. Do not use bleach.

## Monthly

1. Make sure the power cord is unplugged before performing maintenance.
2. Clean the outer body with a soft cloth (paper towel or microfiber cloth). Do not immerse the outer body in water or pour water into it.
3. With warm water rinse the underside of the lid including the sealing ring, and pressure limit valve. Dry completely.
4. Clean the area under upper ring with dampened cloth or microfiber cloth. Do not use chemical cleaners.
5. To clean the sealing ring, hold the knob on the sealing ring supporting cover and pull the sealing ring up. After cleaning, put the sealing ring supporting cover back. Note: The side with the knob should face outward. Do not put it upside down (Figures a and b).

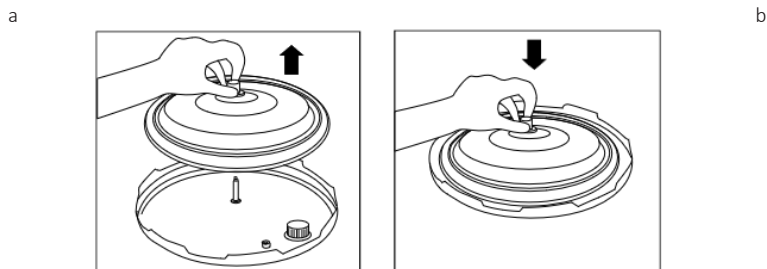

6. Inspect the rubber grommet for wear. Carefully remove the sealing ring supporting cover and inspect the grommet. Replace it with the sealing gasket kit if worn.
7. To clean rubber grommet located in center of sealing ring supporting cover, carefully remove the sealing ring supporting cover and clean the grommet; then reinstall it.

## Disinfecting

1. Make sure the power cord is unplugged before disinfecting.
2. Disinfect the outer body with a soft cloth (paper towel or microfiber cloth) using 95% isopropyl alcohol. Do not immerse the outer body in water or pour water into it.
3. Remove the sealing gasket from the lid and the water chamber from the instrument.
  - 1.
4. Disinfect the sealing gasket assembly with a soft cloth and 95% isopropyl alcohol.
  - 2.
5. Disinfect the area under upper ring with a soft cloth using 95% isopropyl alcohol.
  - 3.
6. Disinfect the water chamber, slide canisters, slide basket, and slide holders with a 10% quaternary cleaning agent solution (such as Quaternary Lysol).
7. Complete a Monthly cleaning cycle to remove residual cleaning agents from the instrument.

# Troubleshooting Guide

Symptom	Possible Reasons	Solutions
Lid does not lock	The sealing ring is not properly installed	Reinstall the ring
Cannot open the lid after a run	The pressure is too high	Wait until the pressure drops
	Residue on the sealing ring	Clean the sealing ring
Air/Steam escapes from the rim of the lid	The sealing ring is worn out	Replace using the sealing gasket kit
	The lid is not locked properly	Rotate the lid fully until it fully aligns with the body
	The metal water chamber may be deformed	Contact Biocare Technical Support
Excess steam is escaping from the pressure limit valve and pressure is not building	The pressure limit valve is not placed properly or obstructed	Ensure that pressure limit valve is fully seated on the shaft and free from obstructions
Steam strip did not change (temperature and pressure not high enough)	The metal water chamber may be dented or deformed	Contact Biocare Technical Support
	Program temperature/pressure was not high enough to activate the strip	Use Steam Monitor Strips for protocols above the boiling point of water, color should be a light black
Pressure is not being recorded or is at 0	Program does not use pressure	Only expect pressure readings for protocols above the boiling point.
Display is not showing anything	Unit is not plugged in	Plug the power cord into the unit and then into the wall outlet.
	ON / OFF switch is in the OFF (0) position	Check to see if switch is in the ON (I) position.
Message Appears: ERROR	No water in metal water chamber	Put 525 mL ± 25 mL of deionized or filtered water into the metal water chamber
	No metal water chamber present	Put in the metal water chamber with 525 mL ± 25 mL of deionized or filtered water and metal slide carrier with 3 slide canisters with solution.
	Less than 3 slide canisters are present	Ensure 3 standard slide canisters with solution or deionized or filtered water are present for each run.
	Less than 3 slide canisters are present for double wide slides	Ensure 3 standard wide slide canisters with solution or deionized or filtered water are present for each run.
Message Appears: UNIT COOLING	The metal water chamber is dirty	Thoroughly clean the outside of the metal water chamber including the bottom.
		Allow water to cool to under 80°C or replace deionized or filtered water in metal water chamber and in metal slide canisters with room temperature deionized or filtered water.
Message Appears: UNIT COOLING	Water in the metal water chamber is above 80°C	Allow water to cool to under 80°C or replace deionized or filtered water in metal water chamber and in metal slide canisters with room temperature deionized or filtered water.
Metal water chamber does not sit properly	The metal water chamber may be dented or deformed	Contact Biocare Technical Support

# Quick Instruction Guides

## Instrument Operation

1. Plug in the ARC and turn ON / OFF switch to the ON position (I).
2. Add 525 mL  $\pm$  25 mL of deionized or filtered water and a canister basket with 225 ml  $\pm$  25 mL of HEIRS, DI or filtered water to the metal water chamber. Deviating amounts of water may cause adverse staining results.
3. Add 3 standardslide canisters containing slides and antigen retrieval solution (or deionized / filtered water) to the canister basket.



**WARNING: Ensure the unit is always loaded as described in section Operating Instructions, step 3 (Instrument loading). Repeatedly running the instrument without a water chamber may degrade instrument performance. When this condition is detected, the system will display an error which may become persistent depending on the frequency of occurrence. Contact Technical Support if the error becomes persistent.**

4. Lock the lid.
5. Select run temperature.  
**Note: Altitude affects the maximum allowed protocol temperature. The ARC calculates the highest temperature allowed for accurately controlled operation at any operating altitude.**
6. Select run time.
7. Select the Start Run button at pre-run setting screen to start the protocol.
8. Upon run completion, carefully open the lid. Tilt the lid at 45 and gently shake to drain excess water before fully tilting back the lid. Use extreme caution as steam and liquids can still be very hot!
9. Remove canister basket by grasping the plastic handles. Do not grab the canister basket or the metal slide canisters by the metal – it is very hot!
10. Continue with slide processing.
11. Once the unit is cool, remove metal water chamber and properly dispose of water. Dry outside completely before placing in unit and close the lid.

**Please Note: Before starting a run, the temperature of the ARC should be at least 3°C lower than the desired set point.**

## Software Reports

1. Transfer USB flash drive from ARC to PC.
2. Open ARC Reports Software.
3. Import files from USB flash drive to PC.
4. Select desired reports and appropriate parameters for report format.
5. Print or export reports for record keeping purposes.

# Accessories and User Serviceable Parts

## **ARC Standard Canister**

The ARC is supplied with 3 standard slide metal slide canisters. Metal canisters allow for ideal heat transfer and are the recommended container for holding slides in the ARC when processing standard width slides. Do not use plastic or glass slide holders.

Cat. No. DCA132 (single canister) or DCA132-3PK (3 canisters)

## **ARC Standard Slide Carrier**

The ARC is supplied with 3 slide carriers for use with Standard Slide Metal Slide Canisters. Each carrier has positions for 24 standard width slides.

Cat. No. ARC10161 (single carrier) or ARC10161-3PK (3 carriers)

## **ARC Double Wide Slide Carrier**

Double wide slide carriers, for use with Standard Wide Slide Metal Slide Canisters, have positions for 9 double wide slides.

Cat. No. ARC10165 (single carrier) or ARC10165-3PK (3 carriers)

## **ARC Metal Rack Holder (Basket)**

The reversible Canister Basket comes with the ARC and has two orientations. The handles slide through the rack for use in both orientations. One side holds three Standard Slide Metal Slide Canisters. The reverse side is not supported by the ARC system.

Cat. No. ARC10163

## **ARC Sealing Gasket Kit**

The sealing gasket kit is a part of the ARC that needs to be replaced on a routine basis.

Cat. No. ARC10146

## **ARC Pressure Limit Valve**

Cat. No. ARC10144

## **ARC Condensation Collector**

Cat. No. ARC10139

## **ARC Steam Cover**

Cat. No. ARC10164

## **ARC Flash Drive with Reporting Software**

Replacement flash drive for the ARC includes reporting software.

Cat. No. ARC10170

# Consumables

## Steam Monitor Strips

The heat and pressure sensitive steam strip allows the end-user to monitor both pressure and heat inside the ARC. The best temperature for a Steam Monitor strip to show quality control is above the boiling point of water. It is at this temperature and relative pressure that a dark brown to black color is achieved. Lower temperature and pressure will produce a lighter strip. The steam strip can be dated and recorded for tracking purposes.

Cat. No. 613D

## QC Heat-Tested pH Strips

The pH of retrieval solutions at high temperatures can be critical for proper staining of the tissue. However, the pH of retrieval solutions can change at high temperature. To ensure quality control and consistent staining, Biocare Medical has developed heat-tested strips that give accurate and true pH at high temperatures. The

Cat. No. PH615 (pH 4-7); Cat. No. PH616 (pH 7.5-10.5)

## Retrieval Solutions









Biocare Medical retrieval solutions are specially formulated for pH stability at high temperature. Our retrieval solutions incorporate Assure™ technology that contains a color-coded pH indicator for quality control and visual inspection.

Refer to Biocare Medical catalog or <http://biocare.net/products/ancillaries/antigen-retrieval>





# Summary of Accessories, User Serviceable Parts, and Consumables

Item	Catalog Number
ARC Standard Canister	DCA132 (1 canister) DCA132-3PK (3 canisters)
ARC Standard Slide Carrier	ARC10161 (1 carrier) ARC10161-3PK (3 carriers)
ARC Double Wide Slide Carrier	ARC10165 (1 carrier) ARC10165-3PK (3 carriers)
ARC Metal Rack Holder (Basket)	ARC10163
ARC Sealing Gasket Kit	ARC10146
ARC Pressure Limit Valve	ARC10144
ARC Condensation Collector	ARC10139
ARC Steam Cover	ARC10164
ARC Flash Drive with Reporting Software	ARC10170
Steam Monitor Strips	613D
QC Heat-Tested pH Strips	PH615 (pH 4-7) PH616 (pH 7.5-10.5)

## Symbol Glossary

	ETL Approved
	Manufacturer
	Serial number
	Consult instructions for use (consult operating instruction)
	Power
	Power Socket
	USB connector
	Research Use Only
	Directive 2012/19/EU: Waste electrical and electronic equipment (WEEE)

## Warning Symbol Glossary

	Hot Surface		Biohazard
	Caution, consult accompanying documents		Electrical Shock Hazard
	Pinch/Crush Hazard		

Please contact Biocare Medical Technical Support if any problems arise: 800-799-9499 Option 3.



## Software Errors

Error	Description
011	Incorrect checksum
100	Pressure valve error
101	Ambient pressure error
200	Temperature is above the safety limit
201	Temperature is out of range
202	Temperature is out of range during the hold phase
204	Heater temperature exceeds limit during ramp
205	Heating too quickly (thermal mass too low)
300 to 302	Error writing to USB
303	Serial number error (unassigned)
304 to 316	Error writing to USB
501	Current out of range when the heater is on
502	Voltage out of range when the heater is on
800	Power measurement error
801	Thermistor error
802	Analog to digital converter error
803	Real time clock error
804	Flash memory error
805	Display error
806	USB serial error
807	USB controller error
808	USB controller response error
809	Firmware validation error
990	Current out of range when the heater is off
991	Voltage out of range when the heater is off

If an error occurs during a run, it will be recorded in the run history (and downloaded data) with an **F** appended to the **Hold Time** field.

Run History				
Date	Hold Time	Start Time	°C	psi
MM/DD	hh:mm:ss <b>F</b>	hh:mm:ss	TT	p.pp

**BIOCARE** 800.799.9499  
M E D I C A L 60 Berry Drive  
Pacheco CA 94553